

## 2 システム別配線図

### 電源回路

ヒューズ-負荷	2-2
電源回路	2-6

### システム回路

#### エンジン関係

スターティング & イグニッション(ワゴン)	2-8
スターティング & イグニッション(バン)	2-10
フューエルヒーター(2L)	2-13
充電(1G-FE)	2-14
充電(3Y-E)	2-16
充電(2L)	2-18
エンジンコントロール(1G-FE)	2-20
エンジンコントロール(3Y-E)	2-26
グロー	2-31

#### シャシ関係

オーバードライブ	2-72
シフトロック	2-74

#### ボデー関係

リヤウインドウデフォグガー	2-57
パワーウィンドウ	2-58
キー忘れ防止システム	2-61
フロントワイパー & ウォッシャー	2-62
リヤワイパー & ウォッシャー	2-64
電動ミラー	2-66
ドアロック	2-69
オートアンテナ	2-76

#### インストルメントパネル廻り

ラジオ & ステレオ	2-78
ホーン, シガレットライター & クロック	2-80
A/Tインジケータ	2-82
コンビネーションメーター	2-84

#### 灯火類

ヘッドランプ	2-34
インテリアランプ(バン)	2-36
インテリアランプ(ワゴン)	2-38
フォグラмп	2-42
ストップランプ	2-43
バックアップランプ	2-44
リヤライトウォーニング(1G-FE)	2-46
ターンシグナル & ハザード	2-48
コンライト	2-50
テールランプ	2-52
イルミネーション	2-54

#### 空調関係

エアコンディショナー(3Y-E)	2-89
エアコンディショナー(2L)	2-92
オートエアコンディショナー	2-96

#### アースポイント

アースポイント	1-100
---------	-------

2

## J/B NO.1(右カウルサイド)

電 源		負 荷	ページ
15A	ストップランプ	エンジンコントロールコンピューター	2-22
		コンデンサー(ラジオ), リヤコンビランプ(ストップランプ), ランプフェイリアセンサー, センターストップランプ	2-43
		ランプフェイリアセンサー	2-46
		シフトロックコントロールリレー	2-74
15A	エレクトロニクスIG	ヒューエルヒーターリレー	2-13
		オルタネーター(ICレギュレーター)	2-14, 16, 18
		VSV(エアコンアイドルアップ)	2-27
		コンライトスキャナー	2-50
		シフトロックコントロールリレー	2-74
		ヒーターリレー, VSV(エアコンアイドルアップ)	2-89, 90
		ヒーターリレー	2-93
ヒーターリレー, オートエアコンアンプ, コンビネーションバルブ, エアコンスイッチ, オートリレー	2-96, 97		
20A	ワイパー	ワイパーモーター, ウインドシールドワイパーリレー, ウォッシャーモーター, コンビスイッチ(ワイパー & ウォッシャースイッチ)	2-62
		リヤワイパー & ウォッシャースイッチ, リヤウォッシャーモーター, リヤワイパーモーター, ワイパーリレー(IG-FE)	2-64
15A	テールランプ	アイドルアップダイオード	2-22
		フォグランプリレー	2-42
		ランプフェイリアセンサー	2-46
		クロック	2-80
7.5A	ターン	ターンシグナルフラッシャー	2-48
15A	ライター	シフトロックコントロールリレー	2-74
		アンテナモーター	2-76
		シガレットライター, クロック	2-80
7.5A	イグニッション	チャージウォーニングランプ	2-14, 16, 18
		エンジンコントロールコンピューター	2-20
		メインリレー(EFI), サーキットオープニングリレー	2-26
		フューエルカットソレノイド, プレヒータングタイマー	2-31
		ウォーニングランプRH	2-85
7.5A	ラジオ	アウターミラースイッチ	2-66
		アンテナモーター	2-76
		ラジオ & ステレオ	2-78
7.5A	メーター	コンビメーター	2-22, 28
		プレヒータングタイマー	2-31
		コンビメーター(リバースウォーニングランプ), リヤコンビランプLH(バックアップランプ), リヤコンビランプRH(バックアップランプ)	2-44
		リヤライトウォーニングランプ, ランプフェイリアセンサー	2-46
		デフォッガースイッチ, デフォッガーリレー	2-57
		メインリレー(パワー), パワーウインドウリレー	2-58
		キーリマインダー	2-61
		コンビメーター(O/D OFFインジケーターランプ), O/Dソレノイド	2-72
		アンテナモーター	2-76
		コンビメーター(A/Tインジケーター)	2-82
コンビネーションメーター, ウォーニングランプLH, ウォーニングランプRH, ブレーキウォーニングリレー	2-84, 85		
15A	フォグランプ	フォグランプLH, フォグランプRH	2-42
30A	ヒューズデフォッガー	リヤウインドウデフォッガー	2-57

## J/B NO.2(エンジンルーム)

電 源		負 荷	ページ
15 A	EFI	エンジンコントロールコンピューター, サーキットオープニングリレー, ISCV, ダイアグノーシスコネクター, フューエルポンプ	2-20
		エンジンコントロールコンピューター, VSV(エバポ), ダイアグノーシスコネクター, VSV(燃圧制御), フューエルポンプ, エアソレノイドバルブ	2-26, 27
15 A	ハザード・ホーン	ターンシグナルフラッシャー, コンビスイッチ(ターンシグナルスイッチ), ハザードスイッチ	2-48
		ホーンLH, ホーンRH	2-80
15 A	ライター	アンテナモーター	2-76
20 A	ルームランプ	半ドアウォーニングランプ, ラグゲージルームランプ, ルームランプ	2-36
		マップランプ, ルームランプ, カーテシランプLH, カーテシランプRH, 半ドアウォーニングランプ, ラグゲージルームランプ, ルームランプコントロールリレー	2-38, 39
		コンライトスキャナー	2-50
		キーリマインダー	2-61
		ミラーコントロールリレー	2-66
		アンテナモーター	2-76
		ラジオ & ステレオ	2-78
		クロック	2-80
7.5 A	オルター-S	オルタネーター(ICレギュレーター)	2-14, 16, 18
15 A	ヘッドランプ(左)	ヘッドランプLH	2-34
15 A	ヘッドランプ(右)	ヘッドランプRH	2-34
40 A	FL AM1	イグニッションスイッチ(AM1), ヒューズドアロック, ヒューズパワー	2-6
		フューエルヒーター	2-13
30 A	FL AM2	イグニッションスイッチ(AM2), ヒューズEFI	2-6
		イグニッションスイッチ(AM2)	2-8, 31
		イグニッションスイッチ(AM2), スターターリレー	2-10
30 A	コンデンサーファン	コンデンサーファンモーター	2-92
80 A 100 A (注)	FLオルタ	FL AM1, ヒューズヒーター, ヒューズテールランプ, テールランプリレー, ヒューズデフォッガー, ヒューズストップランプ, ヒューズフォグランプ	2-6
		FL AM1	2-13
		オルタネーター(ICレギュレーター付き), FLオルター-S	2-14, 16, 18
		テールランプリレー	2-50
		テールランプリレー, ヒューズテールランプ	2-52, 54
80 A	FLグロー	グロープラグカレントセンサー, グロープラグレジスター	2-31

(注) 80 A : 3Y-E, 100 A : 2L, 1G-FE

2

## J/B NO.4(左カウルサイド)

電 源		負 荷	ページ
10 A	エアコン	マグネットクラッチ, マグネットクラッチリレー, エアコンアンプ	2-89
		マグネットクラッチリレー, コンデンサーファンリレー, コンデンサーファンリレーNo.2, マグネットクラッチ, VSV(エアコンアイドルアップ)	2-92
		マグネットクラッチリレー, マグネットクラッチ, エアコンスイッチ	2-97
40 A	ヒューズヒーター	ブLOWERモーター, ヒューズエアコン	2-89, 90, 93
		ブLOWERモーター	2-96

## ヒューズブルリンク(バッテリー横)

2.0L	FLメイン	ヘッドランプリレー, ヒューズヘッドランプ(左), ヒューズヘッドランプ(右), FL AM2, ヒューズルームランプ, ヒューズハザード・ホーン, FLオルタ, FLグロー, ヒューズオルターS	2-6
		FL AM2	2-8, 10
		FLオルタ	2-13, 52, 54
		FLオルタ, FLオルターS	2-14, 16, 18
		FL AM2, FLグロー	2-31
		ヘッドランプリレー, ヒューズヘッドランプ(左), ヒューズヘッドランプ(右)	2-34
		グロープラグレジスター, グロープラグカレントセンサー, FLオルタ, ヘッドランプリレー	2-50

## サーキットブレーカー(右カウルサイド)

30 A	ヒューズドアロック	ドアコントロールリレー	2-69
30 A	ヒューズパワー	パワーウィンドウリレー, ドアコントロールスイッチ, パワーウィンドウモーター	2-58, 59

---

MEMO

2

- \*1: 3Y-E
- \*2: 除く3Y-E
- \*3: 1G-FE
- \*4: 2L
- \*5: 除く2L

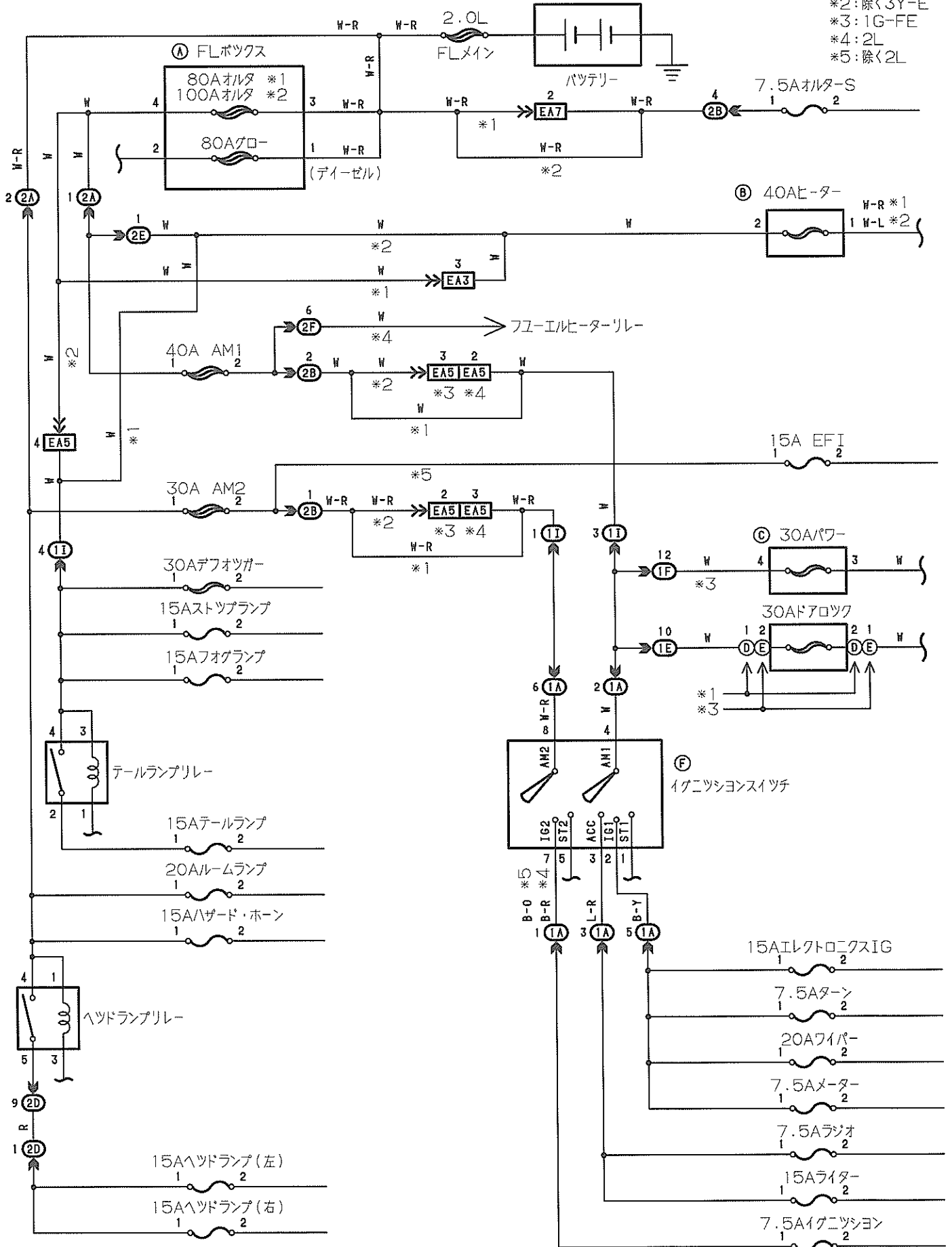

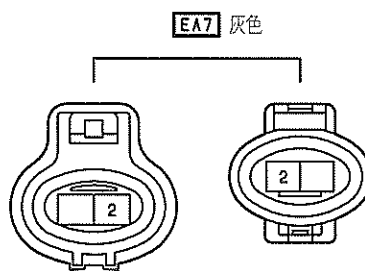
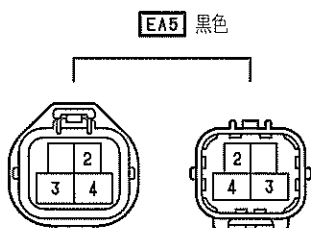
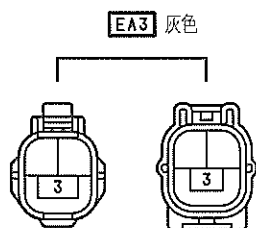
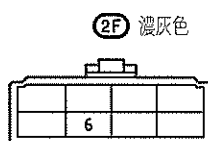
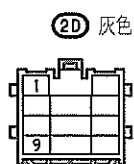
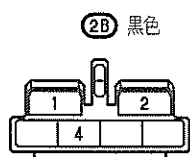
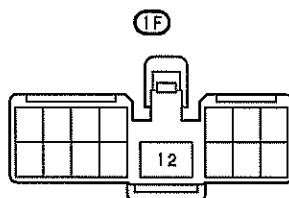
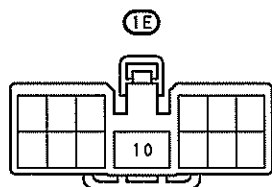
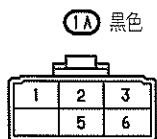
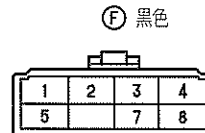
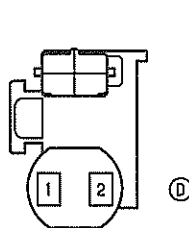
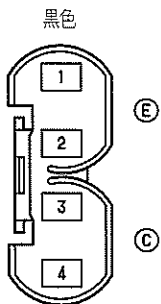
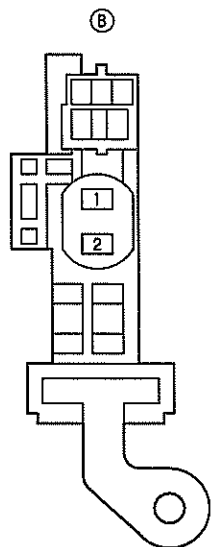
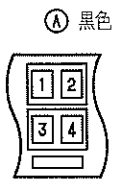



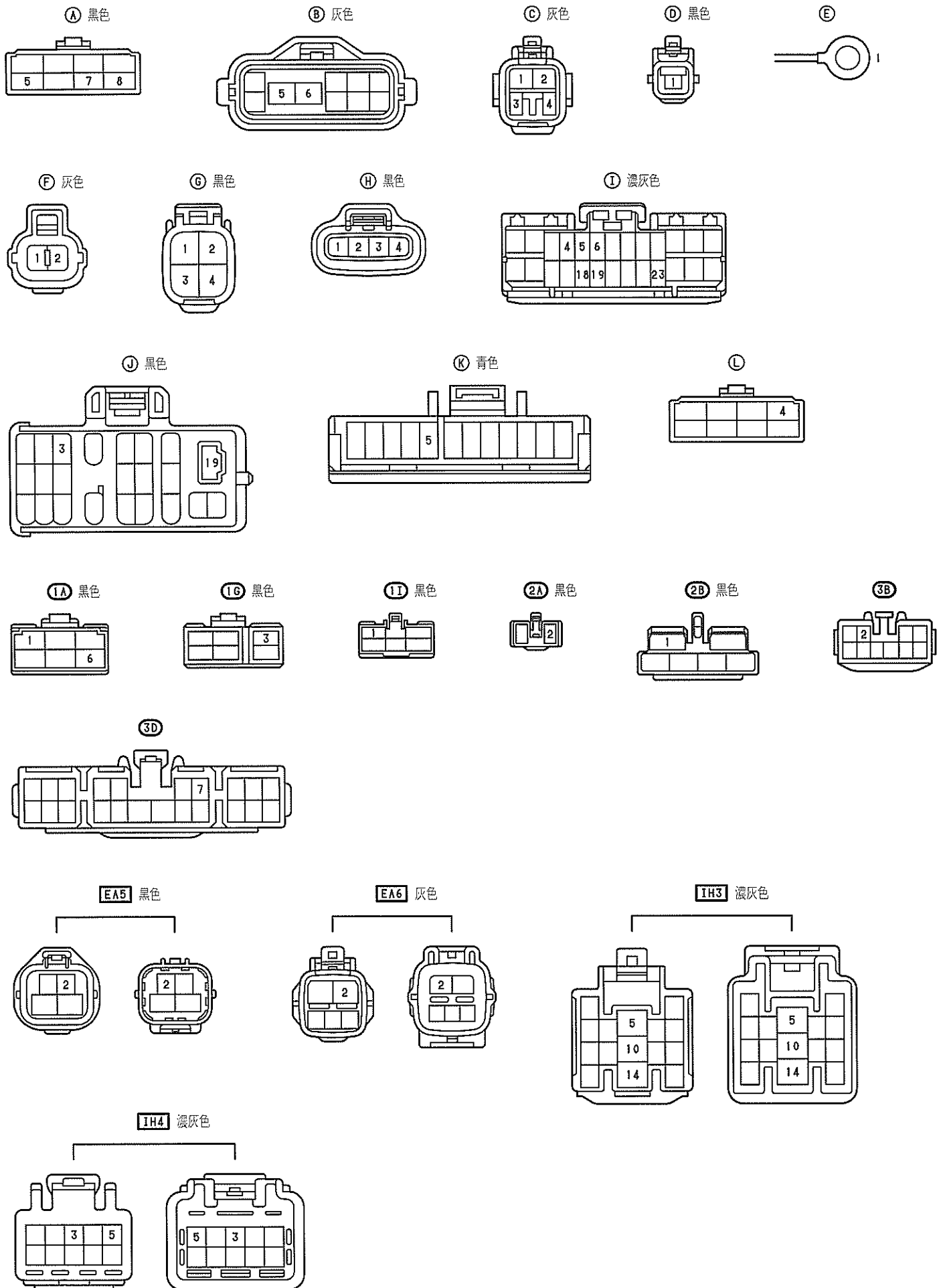



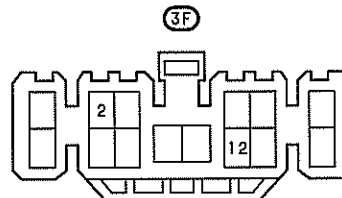
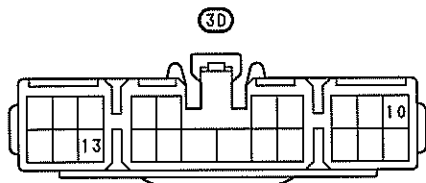
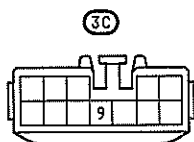
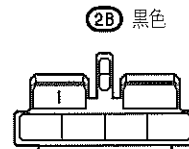
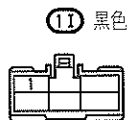
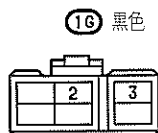
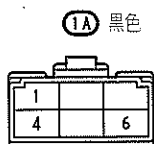
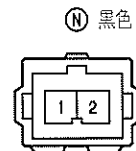
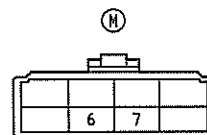
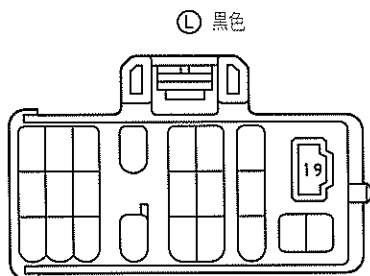
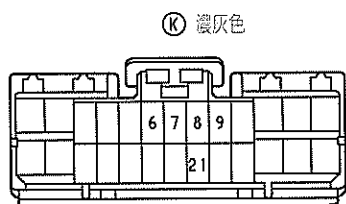
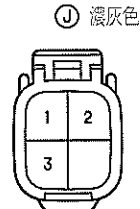
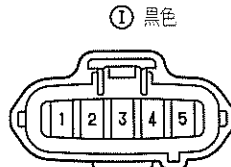
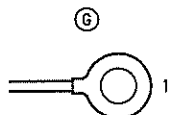
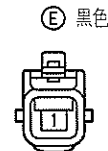
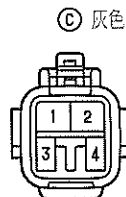
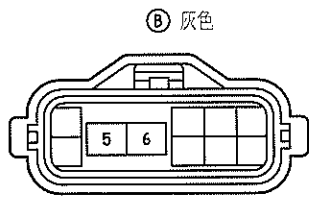
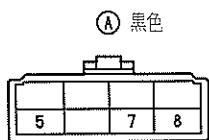

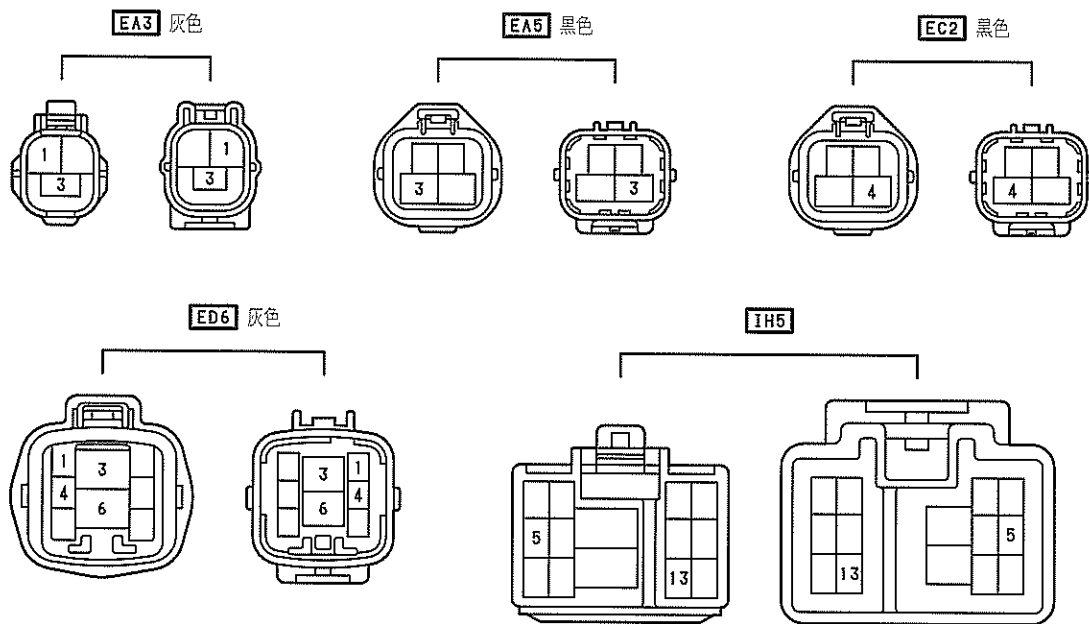



# 充電 ( 1G-FE )

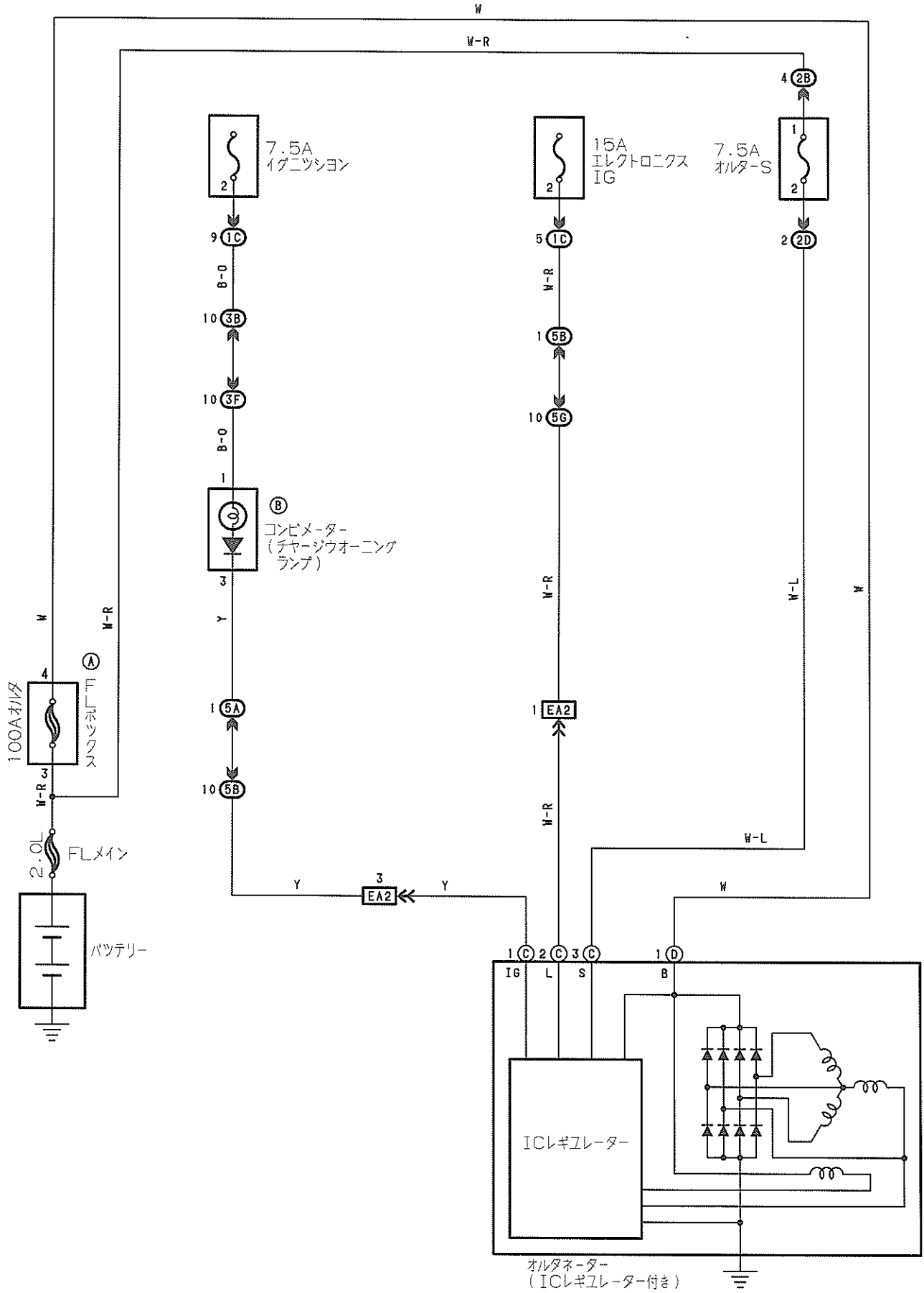

Ⓐ 黑色

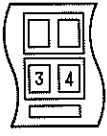

Ⓑ 灰色

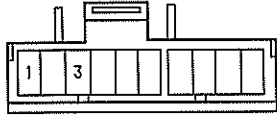

Ⓒ 灰色

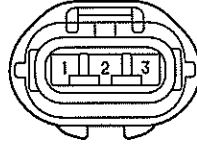

Ⓓ



1Ⓒ

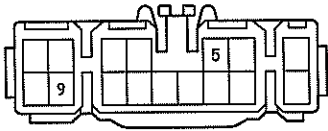

2Ⓑ 黑色

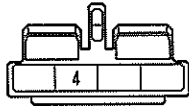

2Ⓓ 黑色

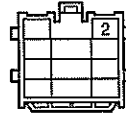

3Ⓑ 5Ⓑ



3Ⓕ

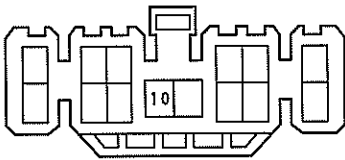

5Ⓐ

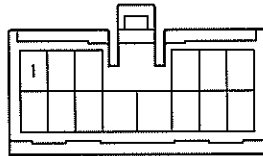

5Ⓖ

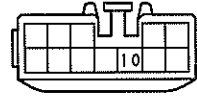

EA2 灰色

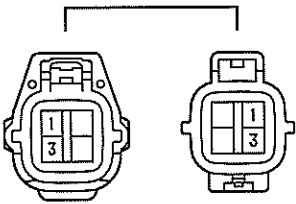

# 充電 (3Y-E)

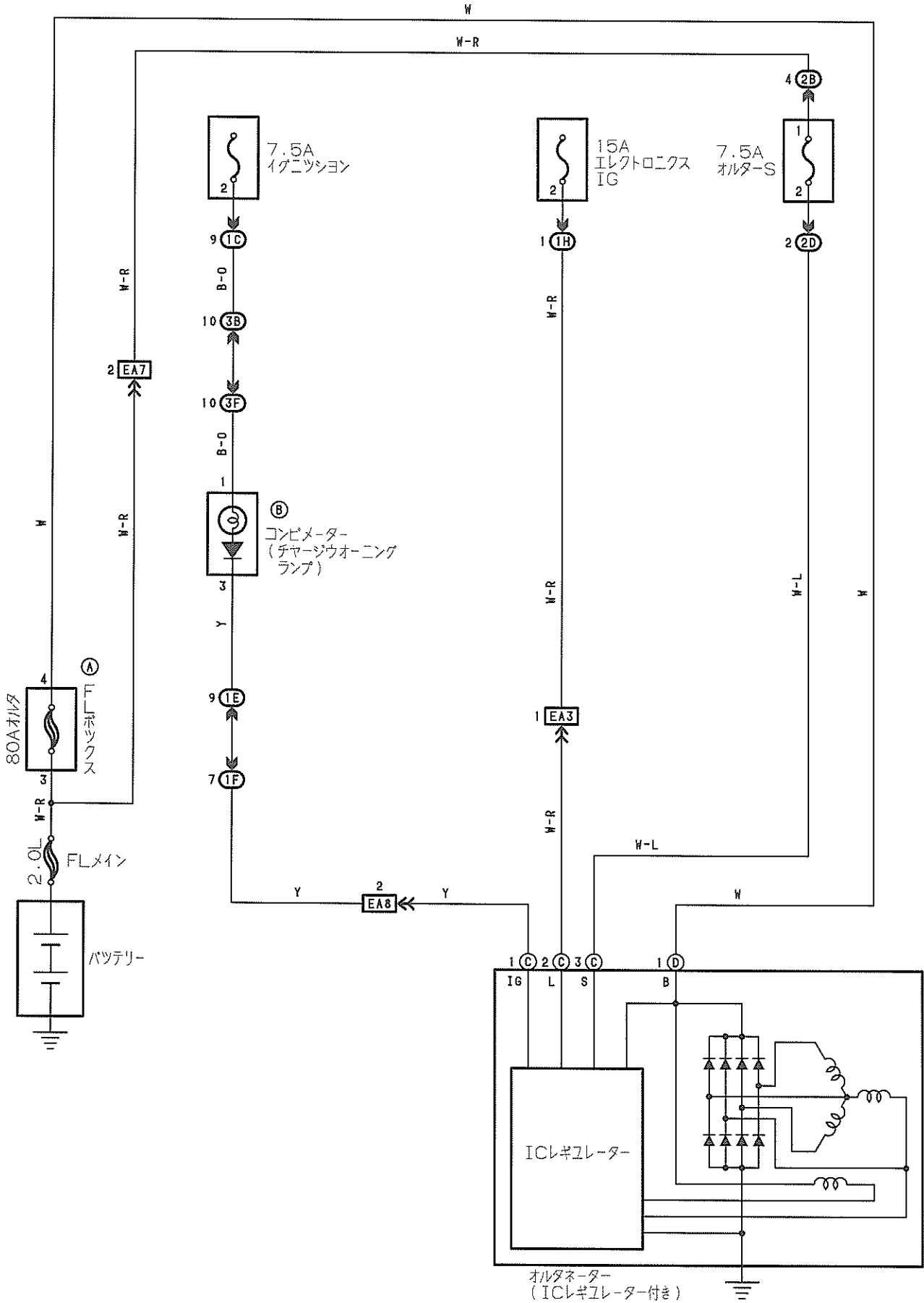

Ⓐ 黑色

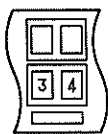

Ⓑ 灰色

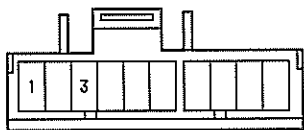

Ⓒ 灰色

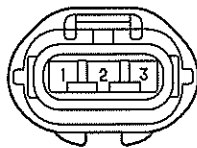

Ⓓ



ⓐ

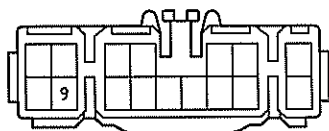

ⓑ

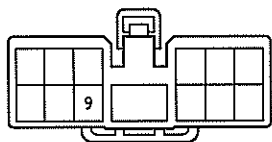

ⓒ

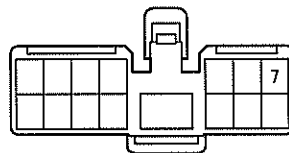

ⓓ

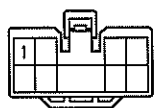

ⓔ 黑色

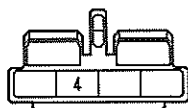

ⓕ 灰色

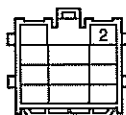

ⓖ



ⓗ

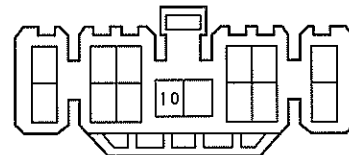

EA3 灰色

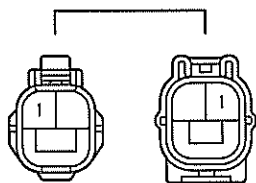

EA7 灰色

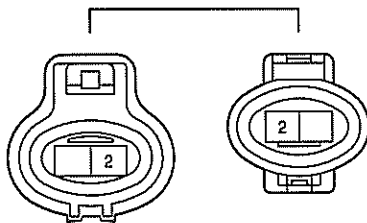

EA8 灰色

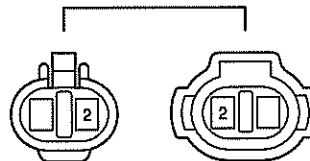

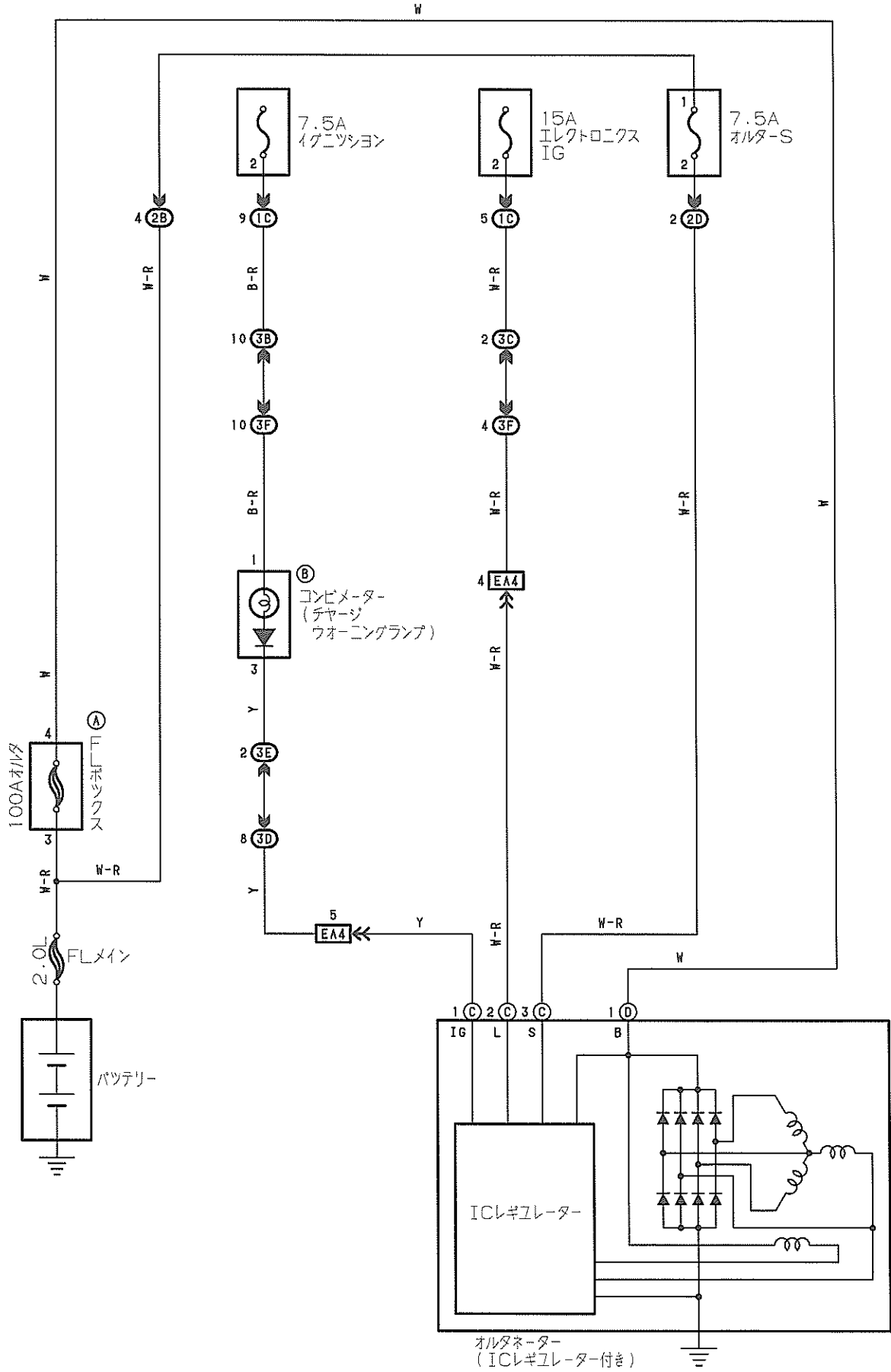

Ⓐ 黑色

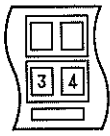

Ⓑ 灰色

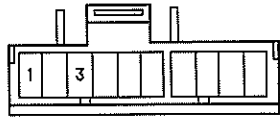

Ⓒ 黑色

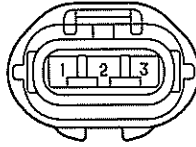

Ⓓ



1C

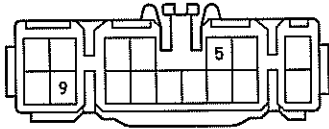

2B 黑色

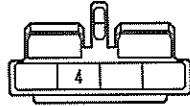

2D 灰色

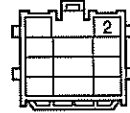

3B

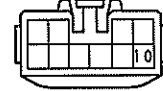

3C

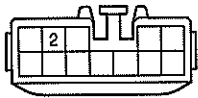

3D

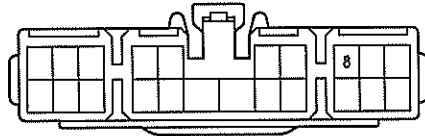

3E

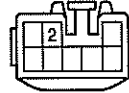

3F

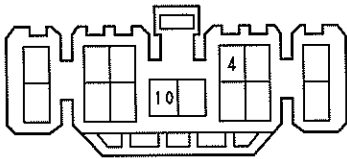

EA4 灰色

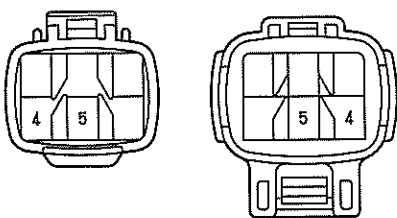

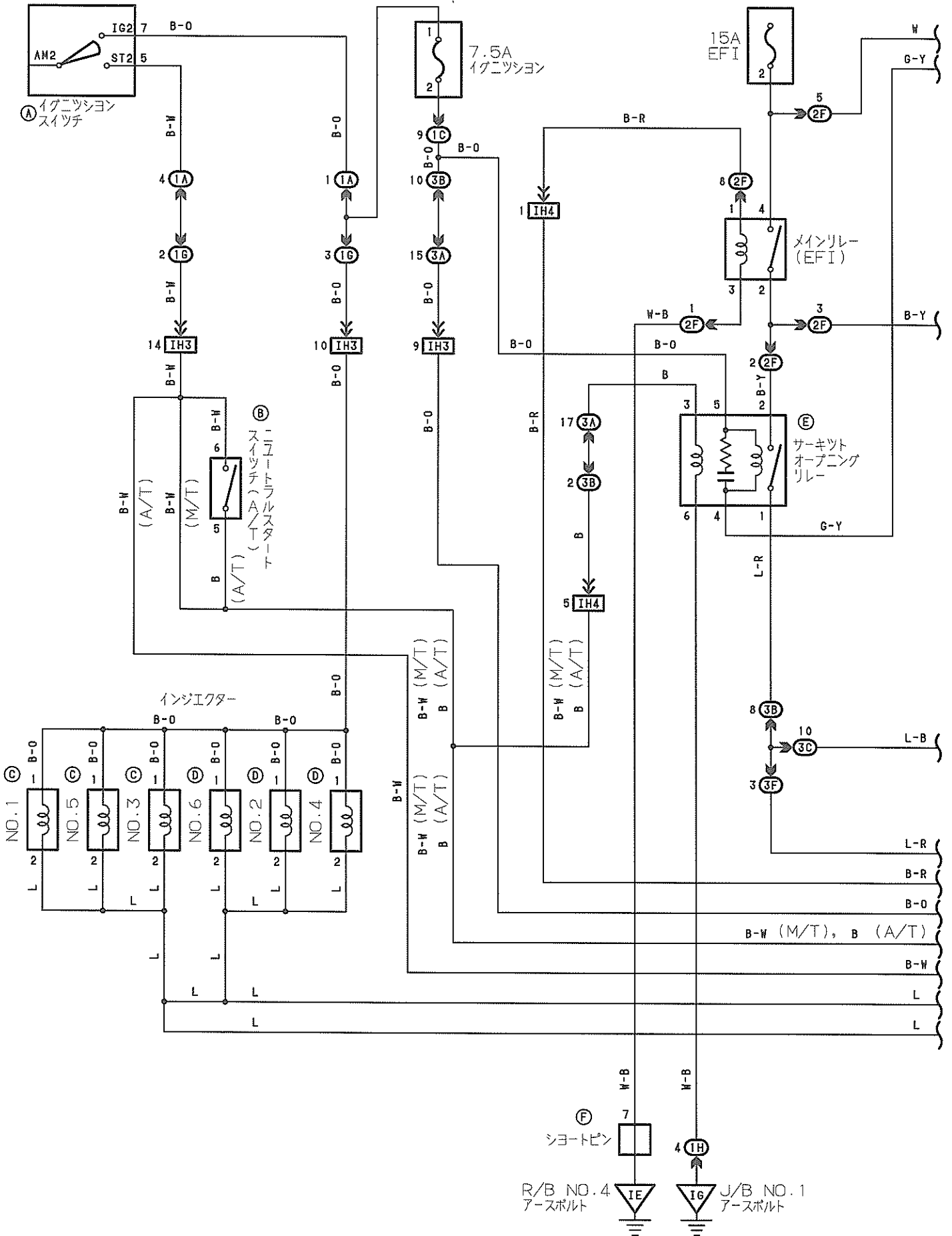

エンジンコントロール  
コンピューター

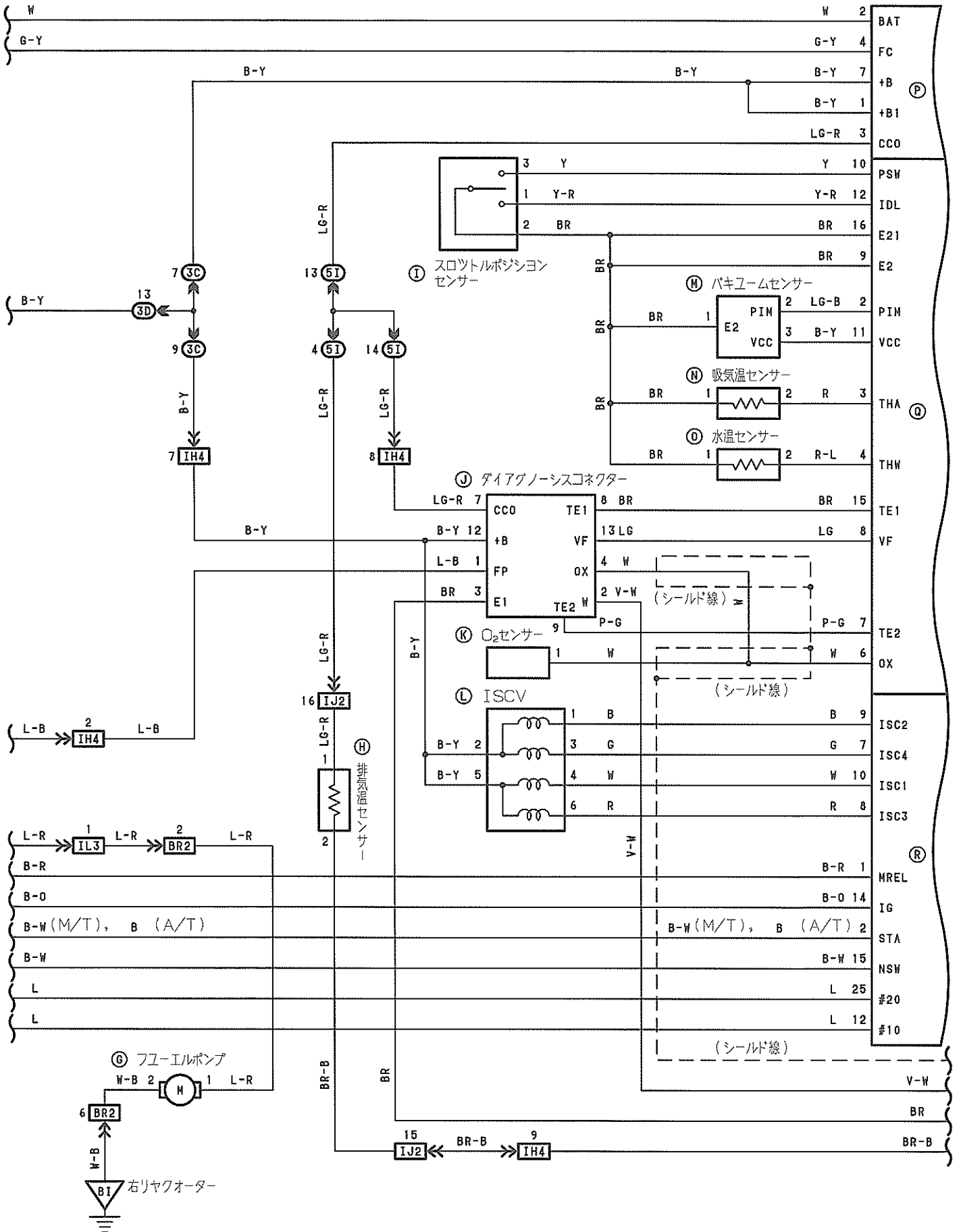

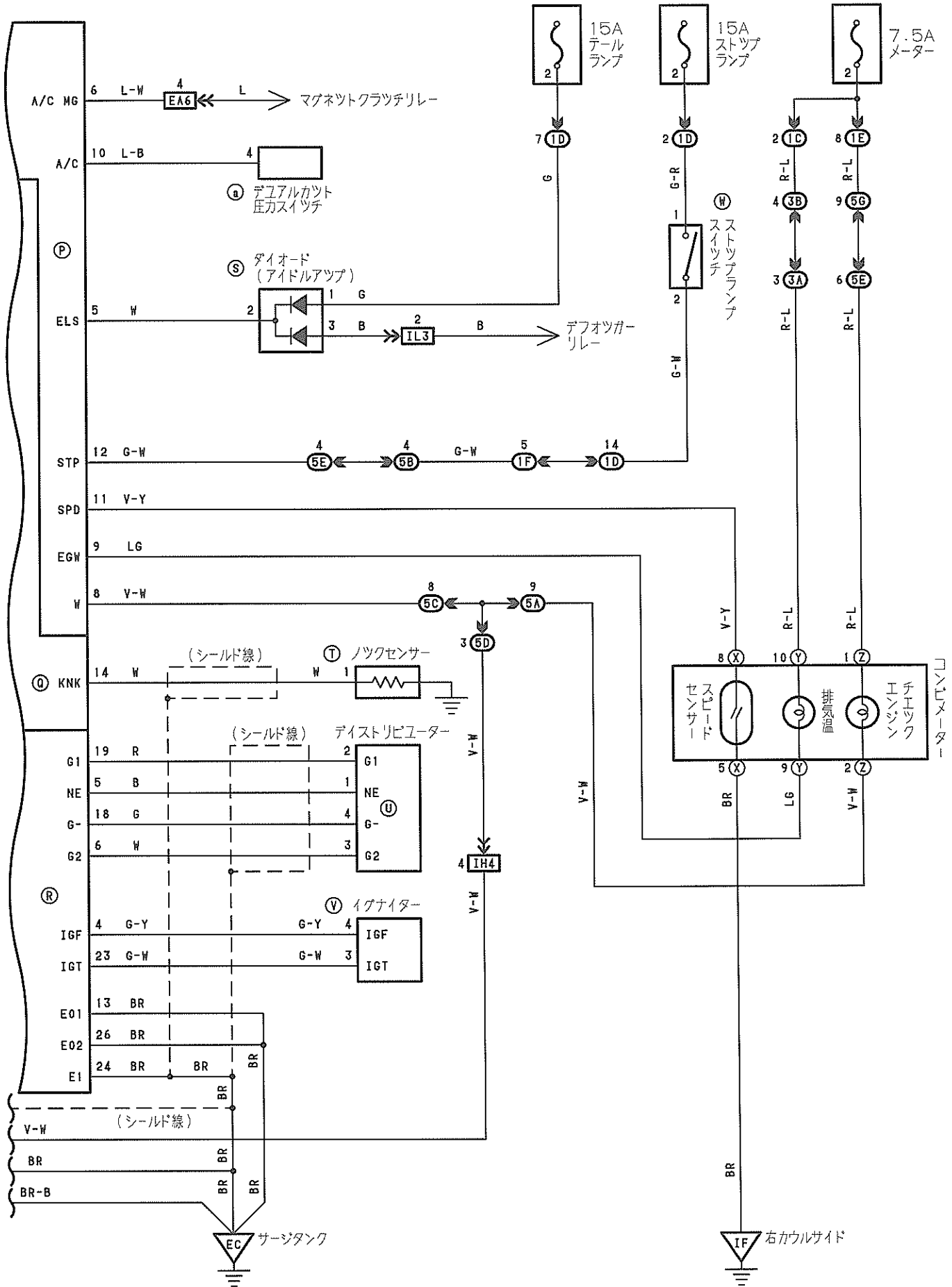

Ⓐ 黒色

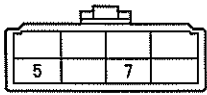

Ⓑ 灰色

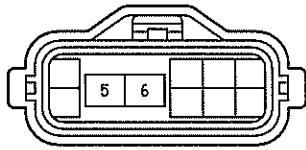

Ⓒ 濃灰色



Ⓓ 茶色



Ⓔ 濃灰色

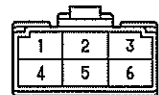

Ⓕ 乳白色

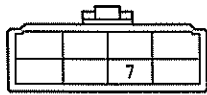

Ⓖ

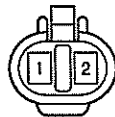

Ⓗ 濃灰色

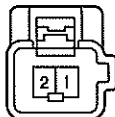

Ⓘ 黒色



Ⓙ 濃灰色

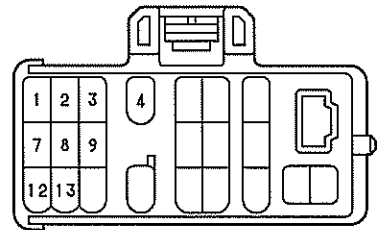

Ⓚ 濃灰色



Ⓛ 灰色

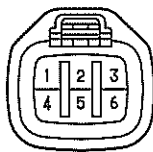

Ⓜ 黒色

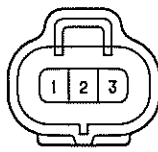

Ⓝ 黒色



Ⓞ



Ⓟ 濃灰色

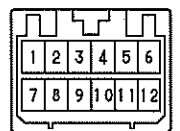

Ⓠ 濃灰色

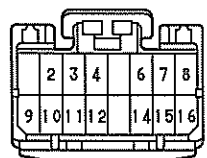

Ⓡ 濃灰色

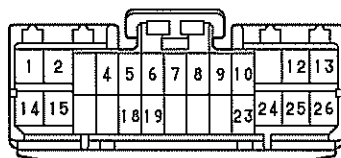

Ⓢ だいたい色

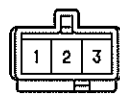

Ⓣ 濃灰色



Ⓤ 黒色



Ⓡ 黒色

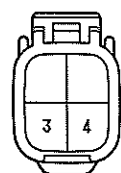

Ⓢ

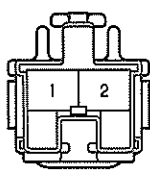

Ⓝ 茶色

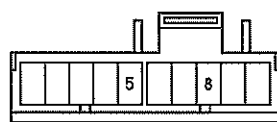

Ⓡ 灰色

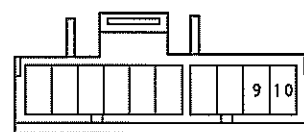

Ⓩ

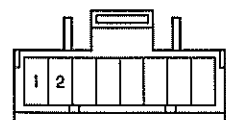

ⓐ 黒色

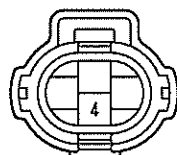

ⓁA



ⓁC

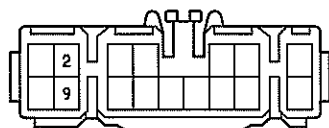

ⓁD 3F

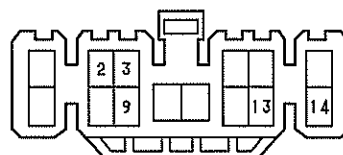

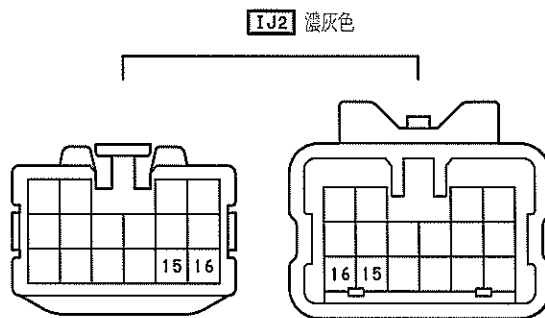
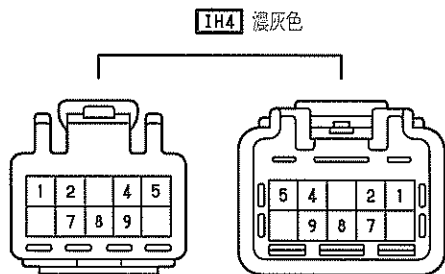
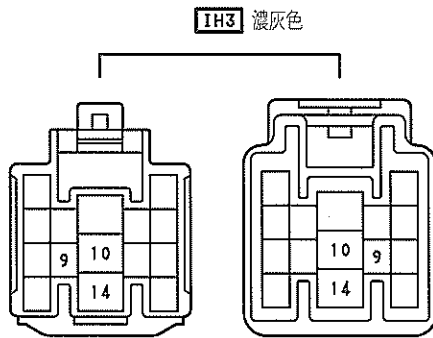
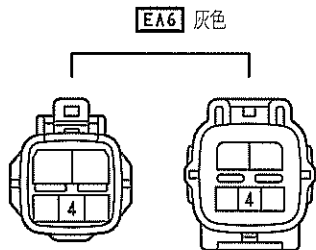
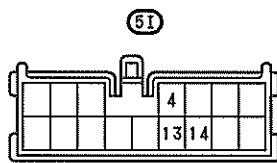
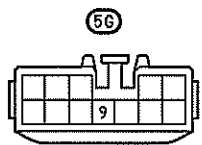
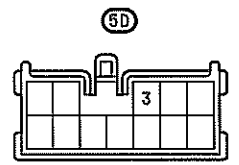
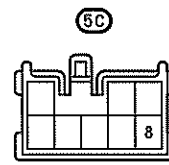
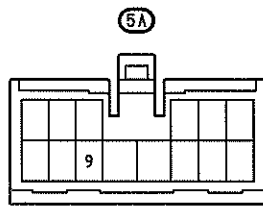
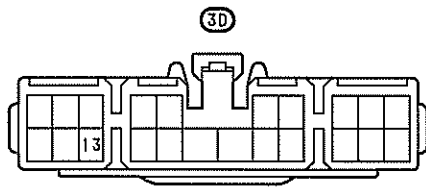
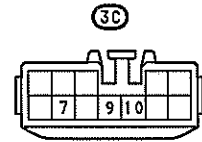
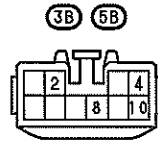
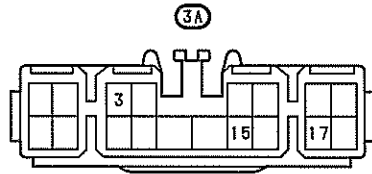
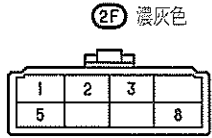
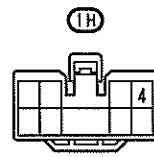
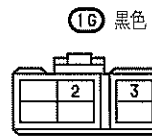
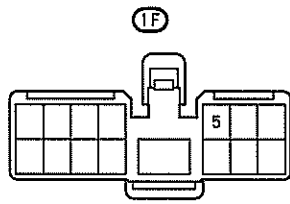
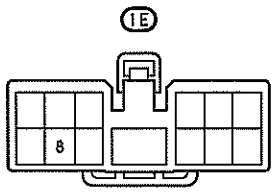

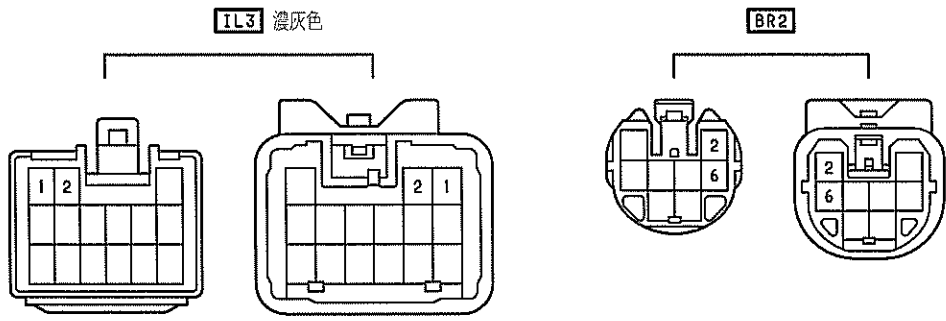

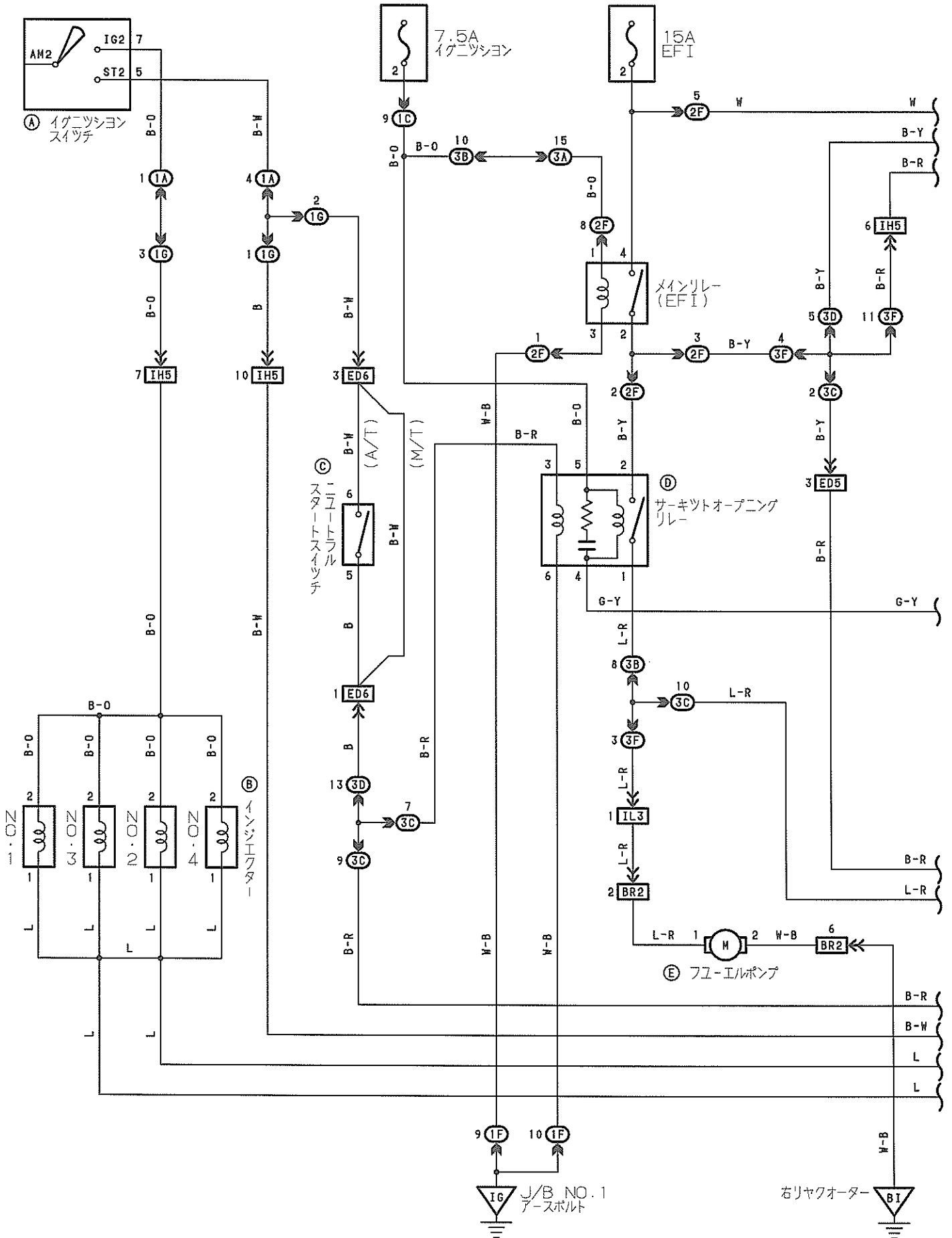

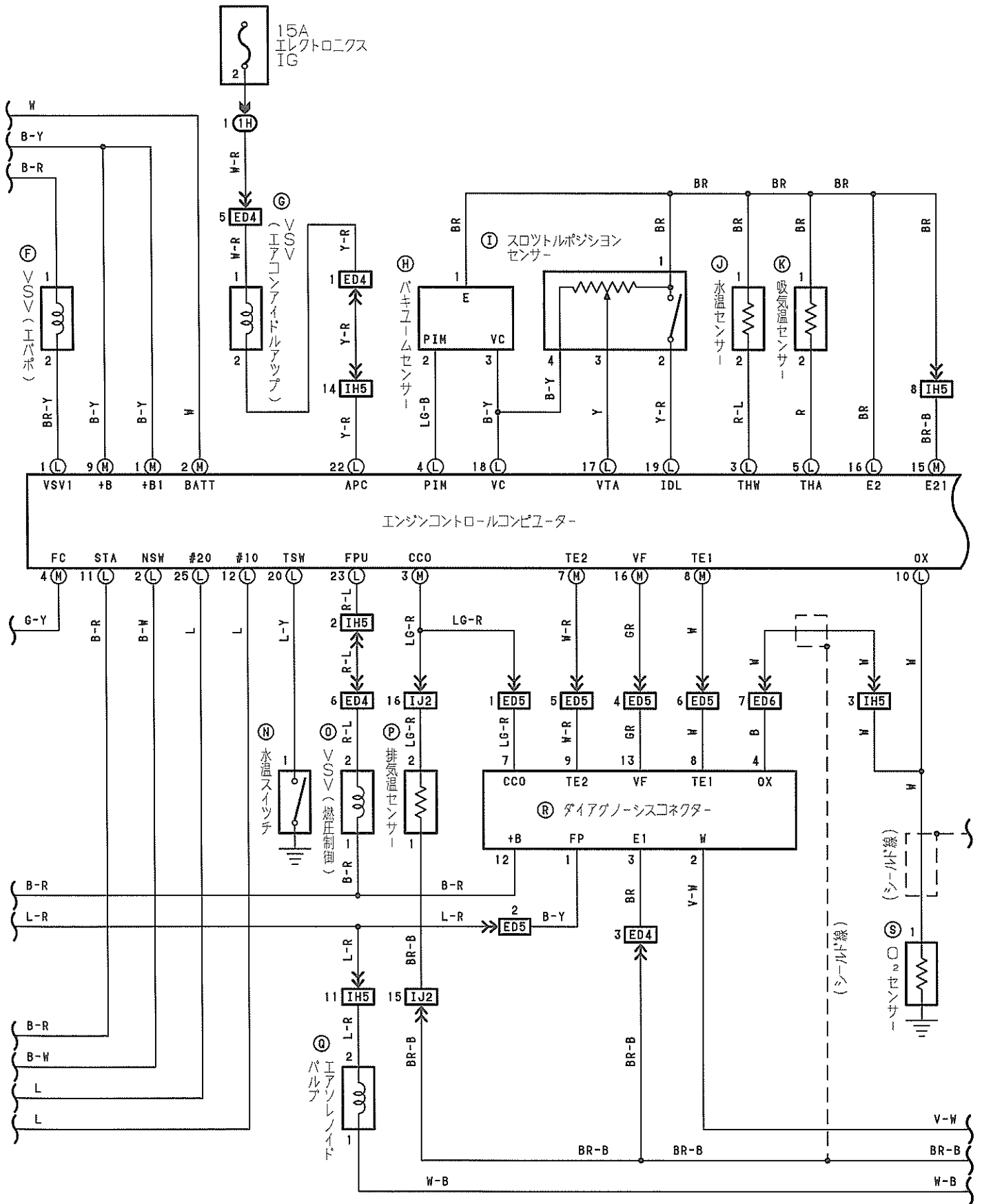

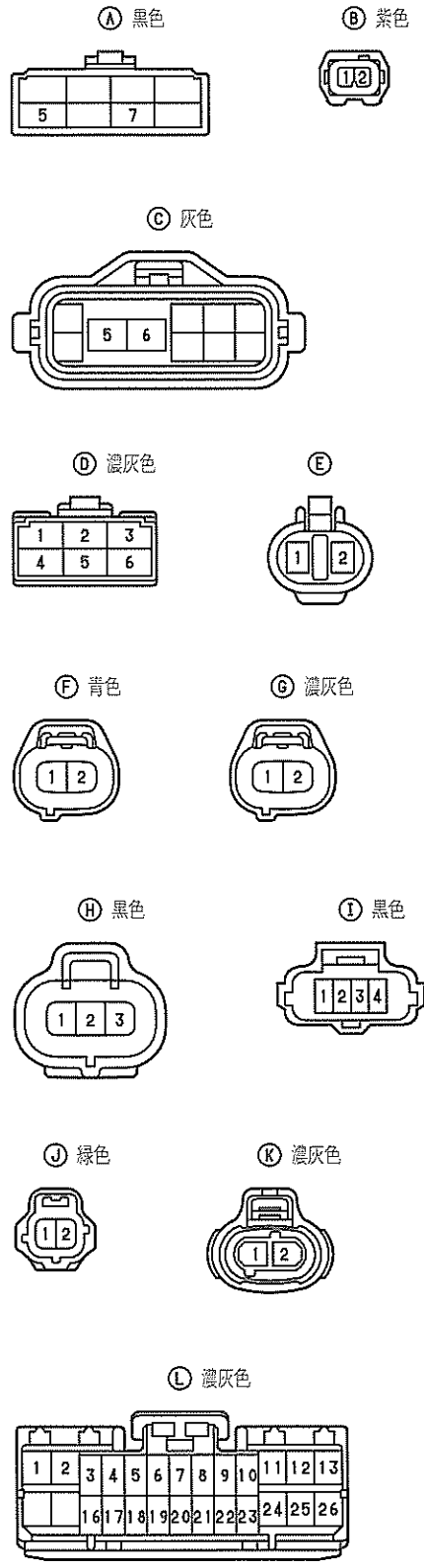
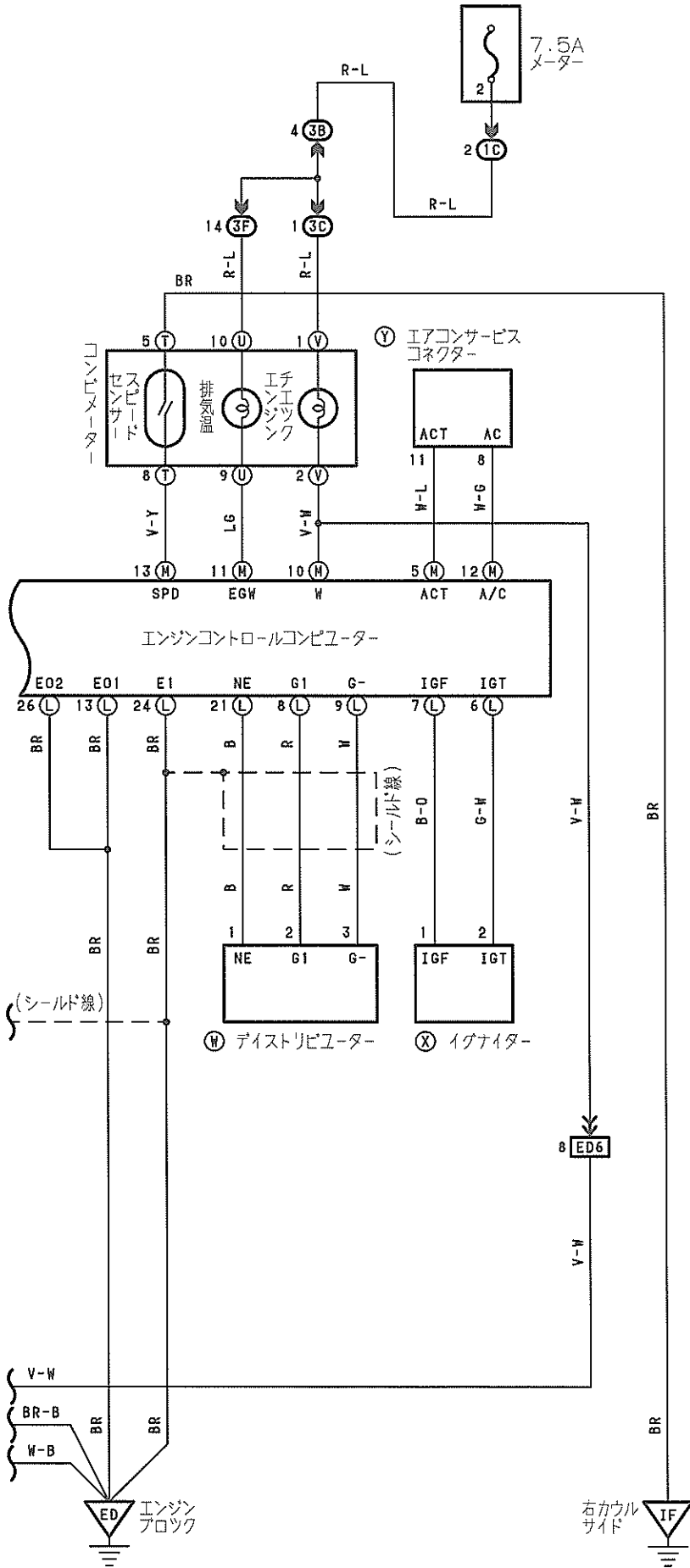

Ⓜ 濃灰色

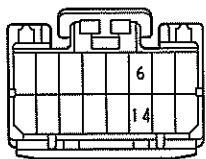

Ⓝ 黒色



ⓓ 茶色



Ⓟ 濃灰色

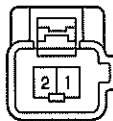

Ⓠ 青色

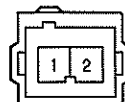

Ⓡ 濃灰色

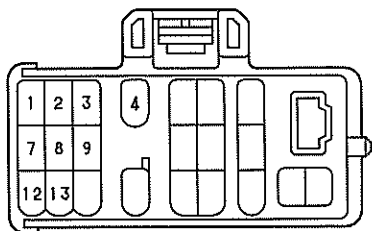

Ⓢ 濃灰色



Ⓣ 茶色

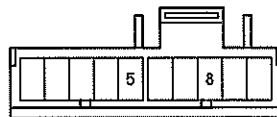

Ⓤ 灰色

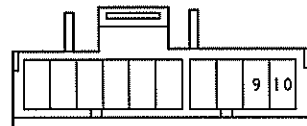

Ⓥ

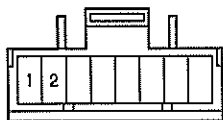

Ⓦ 濃灰色

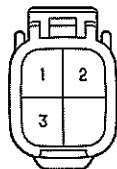

Ⓧ 黒色



Ⓨ

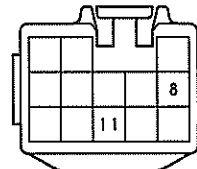

1A 黒色

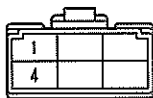

1C

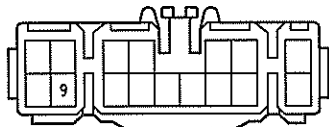

1D 3F

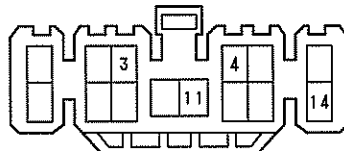

1F

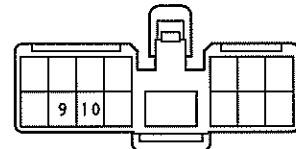

1G 黒色

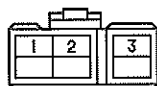

1B

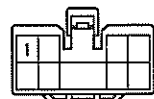

2F 黒色

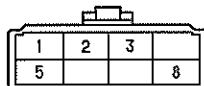

3A

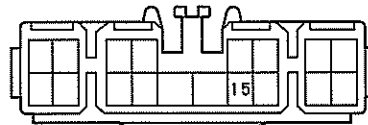

3B

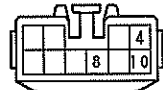

3C

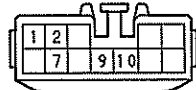

3D

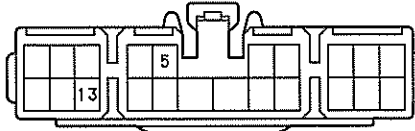

ED4 灰色

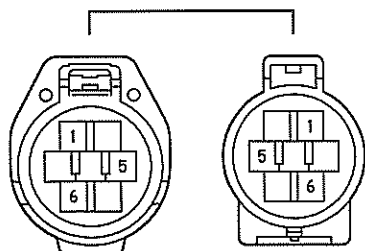

ED5 灰色

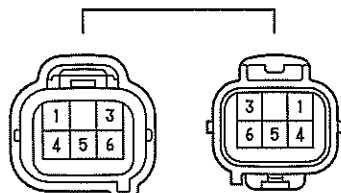

ED6 灰色

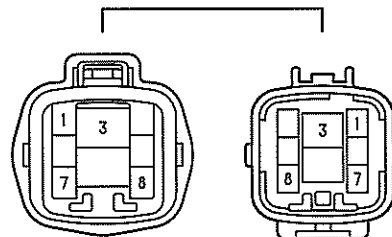

IH5

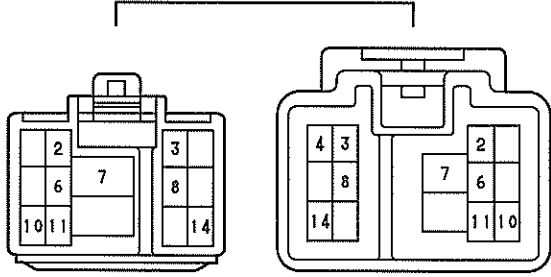

IJ2 濃灰色

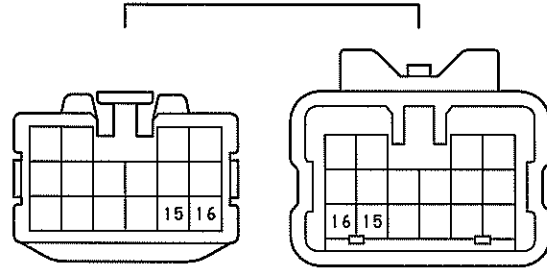

IL3 濃灰色

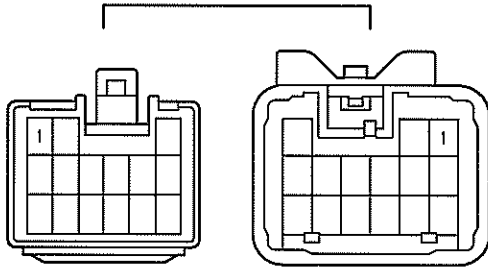

BR2

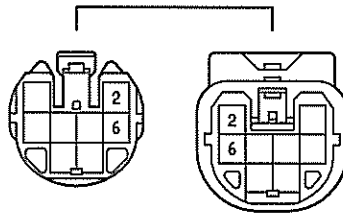



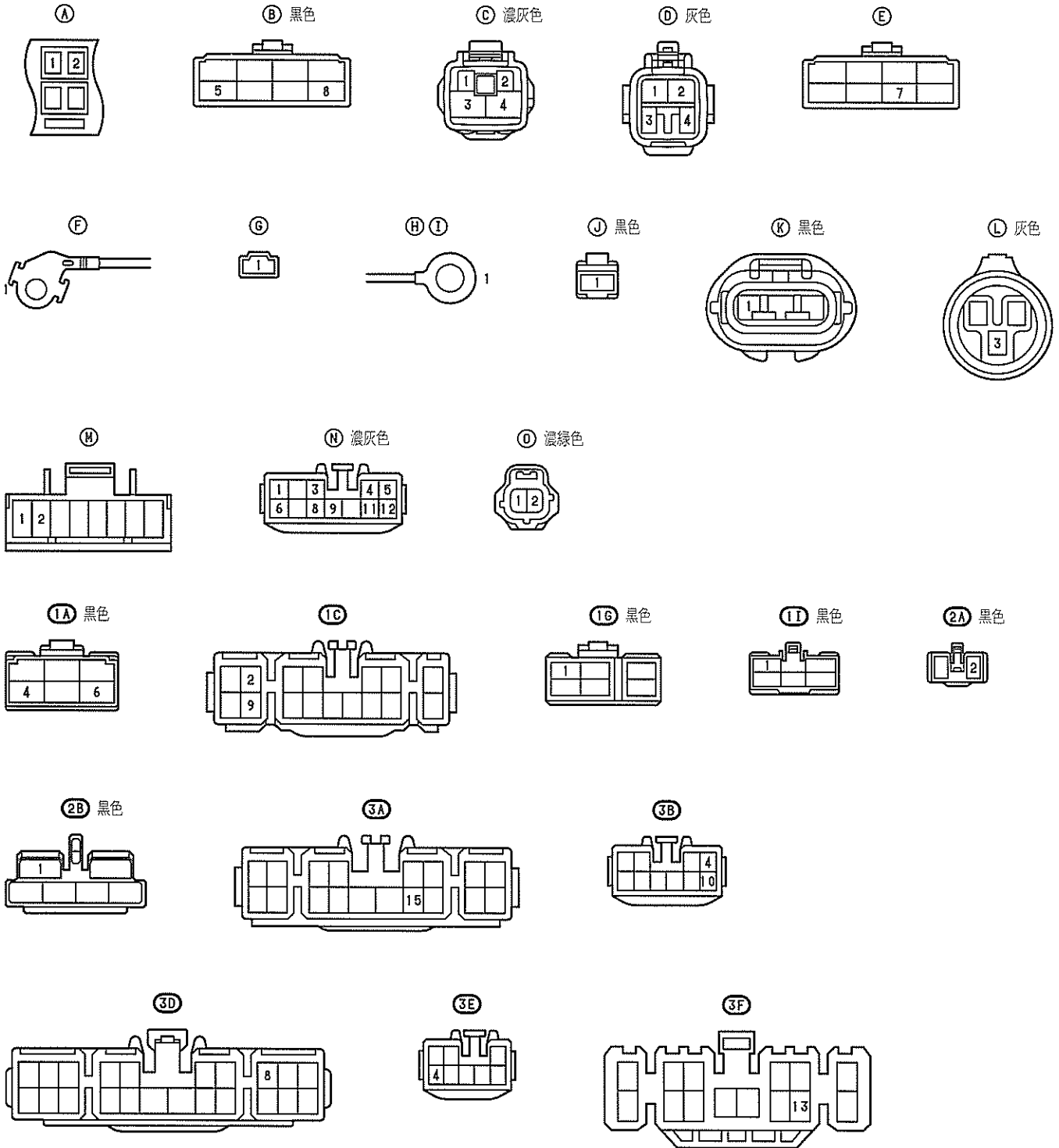

EA1 灰色

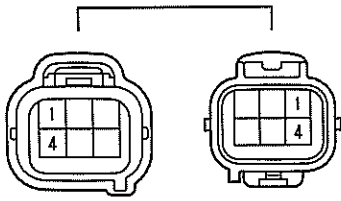

EA3 灰色

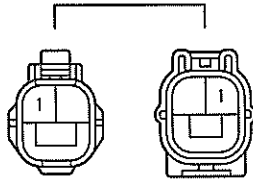

EA4 灰色

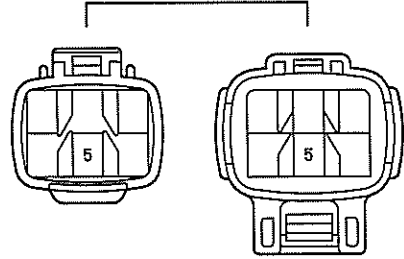

EA5 EC2 黒色

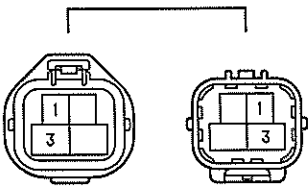

IH1

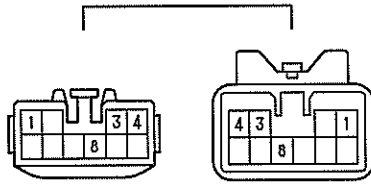

# ヘッドランプ

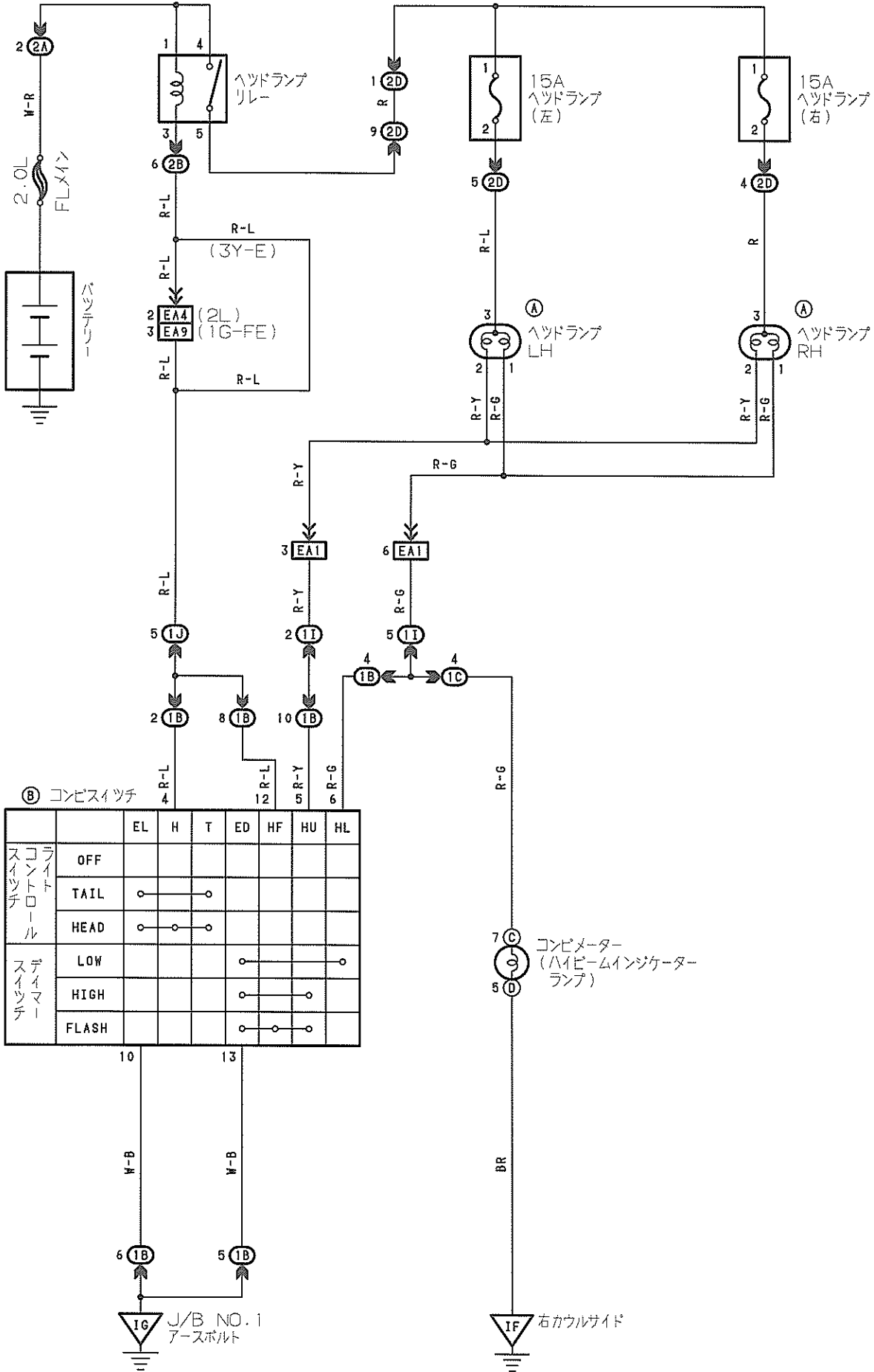

⑧ コンビスイッチ

		EL	H	T	ED	HF	HU	HL
スライツト コントロール	OFF							
	TAIL	○	○					
	HEAD	○	○					
デイ スイッチ	LOW				○	○	○	
	HIGH				○	○	○	
	FLASH				○	○	○	

Ⓐ 灰色

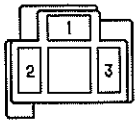

Ⓑ 黒色

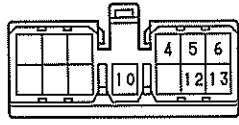

Ⓒ 青色

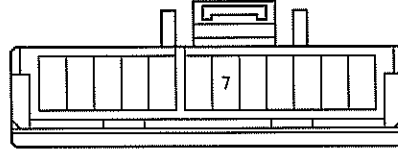

Ⓓ 茶色

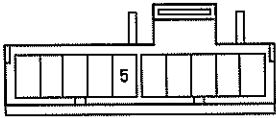

1Ⓑ

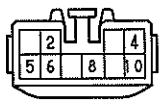

1Ⓒ

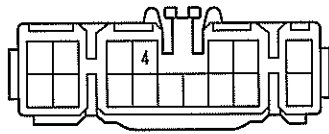

1Ⓘ 黒色

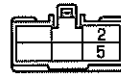

1Ⓙ



2Ⓐ 黒色



2Ⓑ 黒色

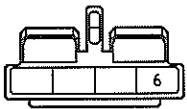

2Ⓓ 灰色

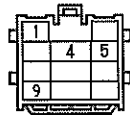

EA1 灰色

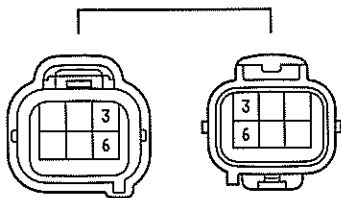

EA4 灰色

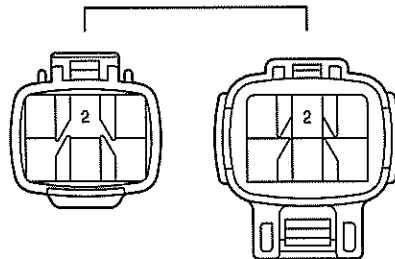

EA9 灰色

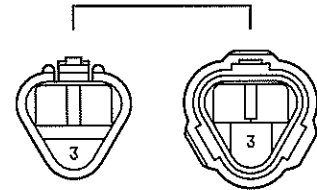

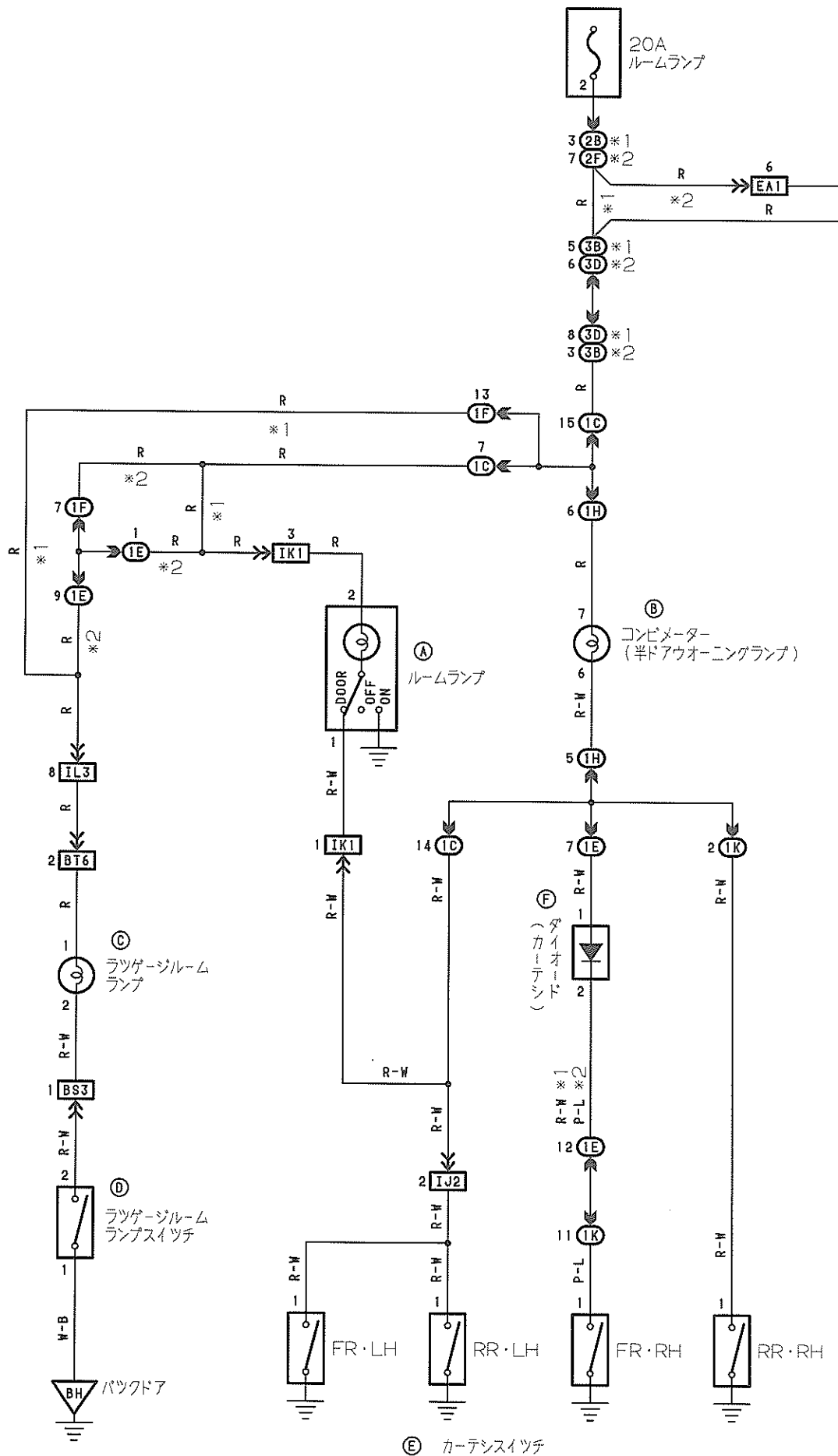

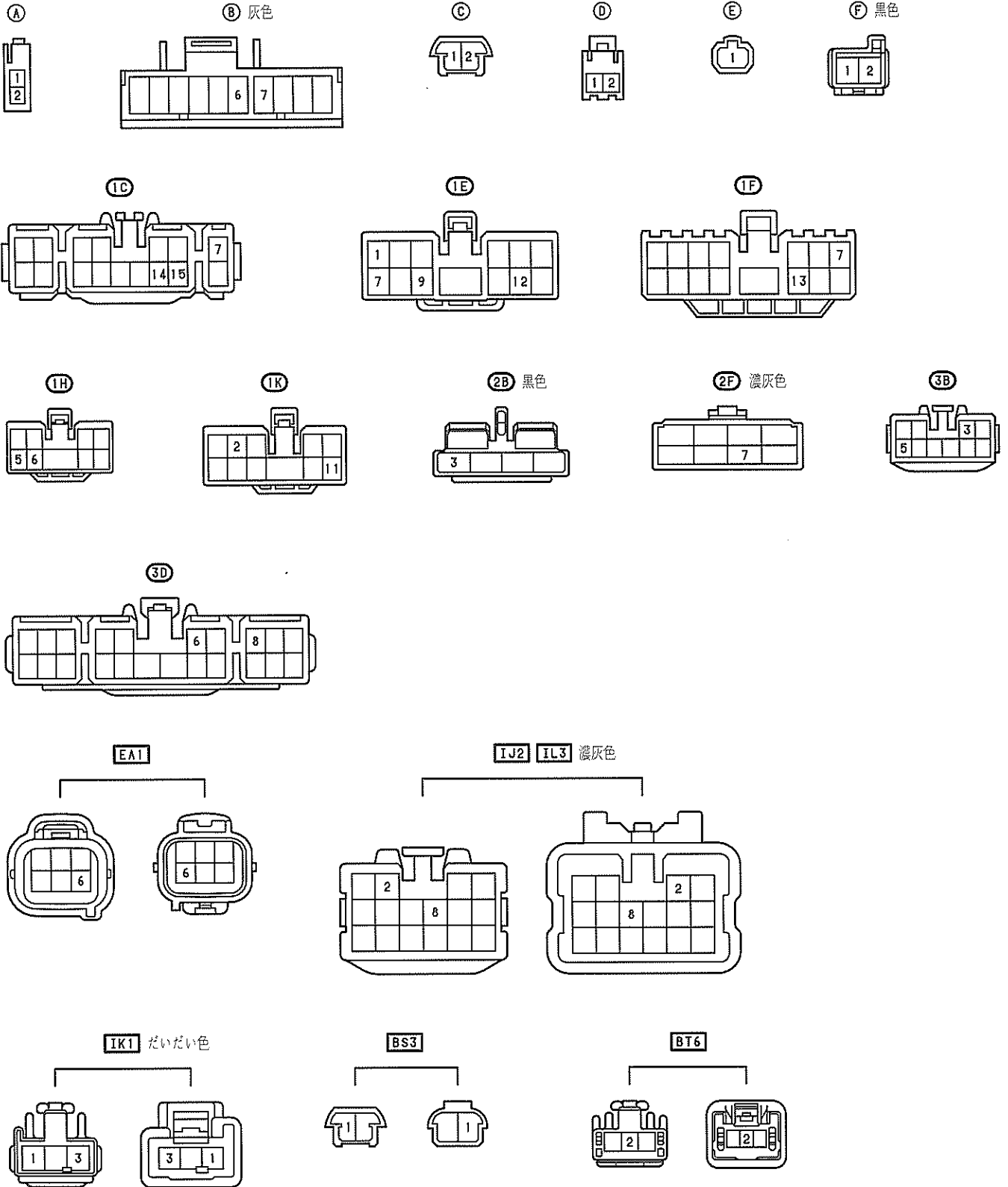



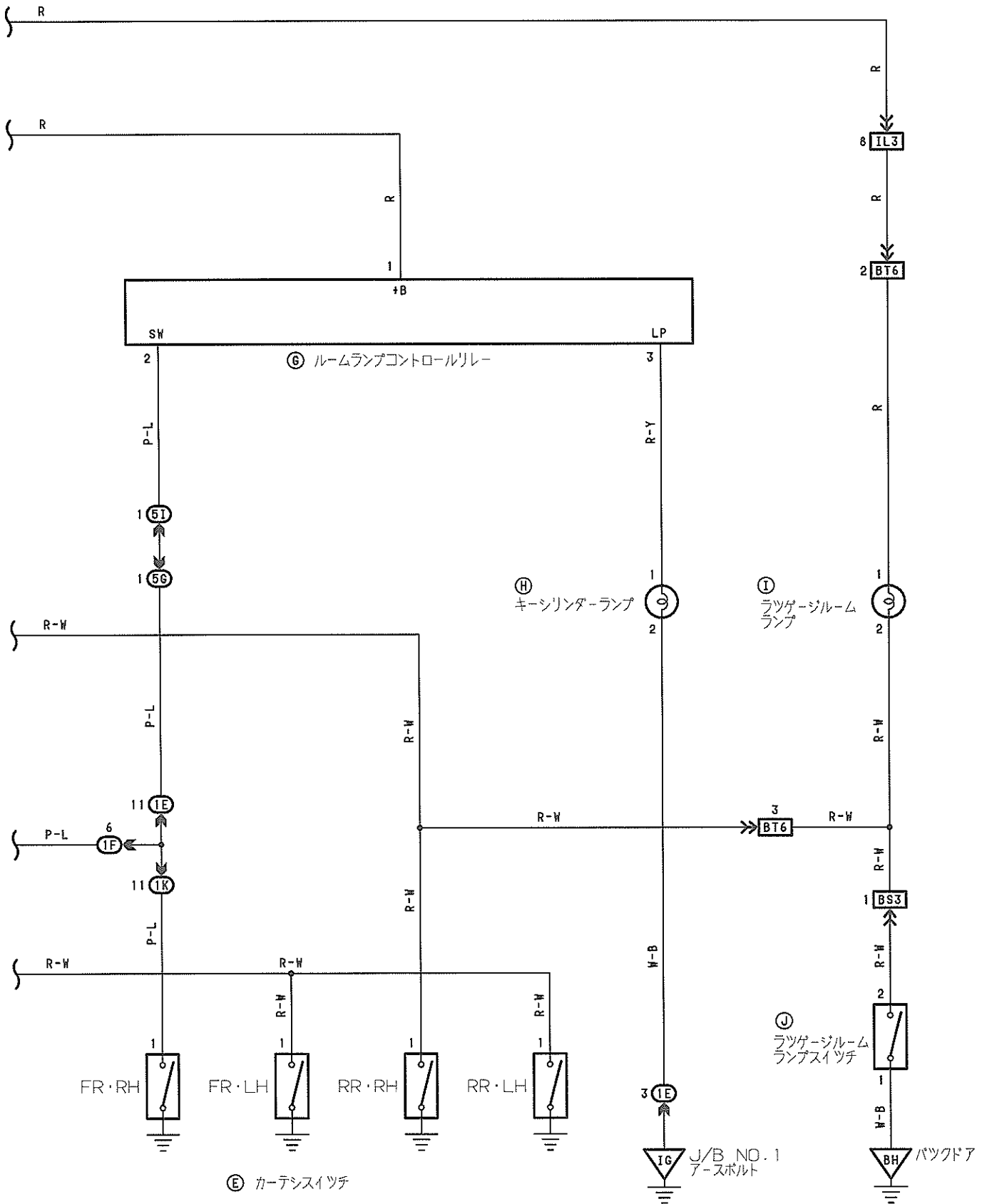

Ⓐ Ⓑ Ⓒ

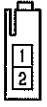

Ⓓ 灰色

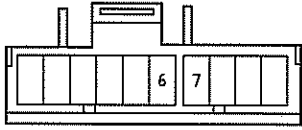

Ⓔ



Ⓕ 黒色

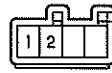

Ⓖ 青色

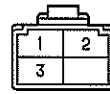

Ⓖ 黒色

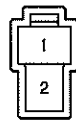

Ⓘ



Ⓙ



Ⓚ

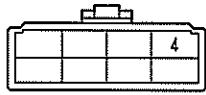

(J/B NO.4)

10

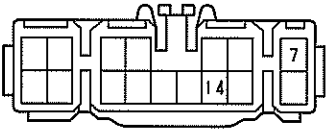

1E

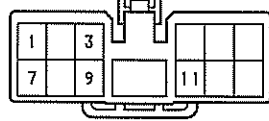

1F

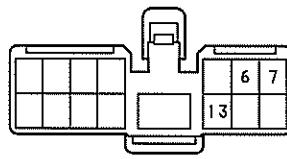

1H

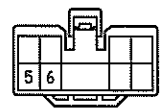

1K

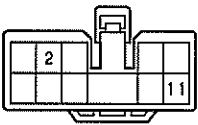

2F 濃灰色

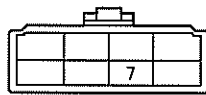

3F 5F

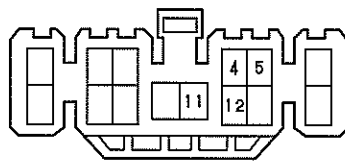

5D

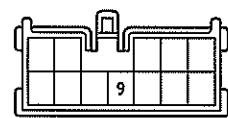

5E

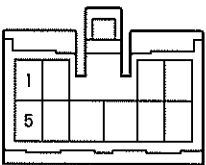

5G

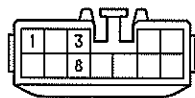

5H

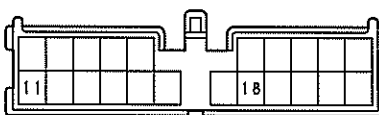

5I

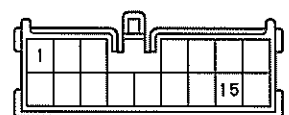

111 青色

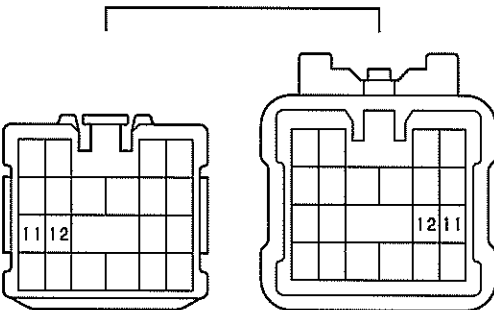

1J2 濃灰色

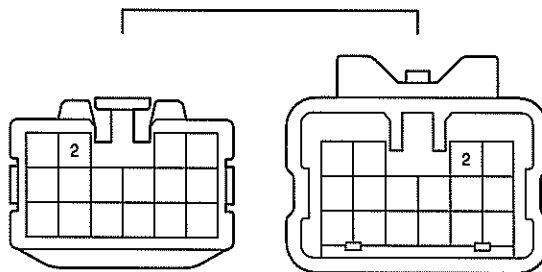

**IK1** だいたい色

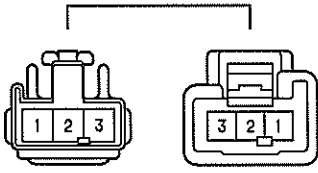

**IL3** 濃灰色

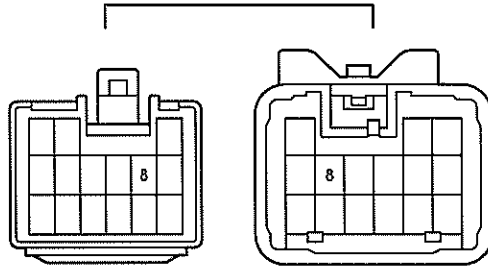

**IM4** 青色

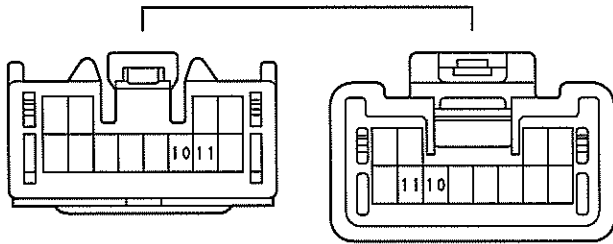

**BS3**

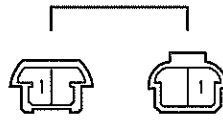

**BT6**

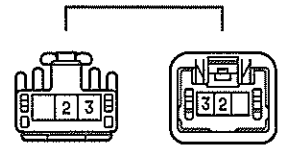

# フォグランプ

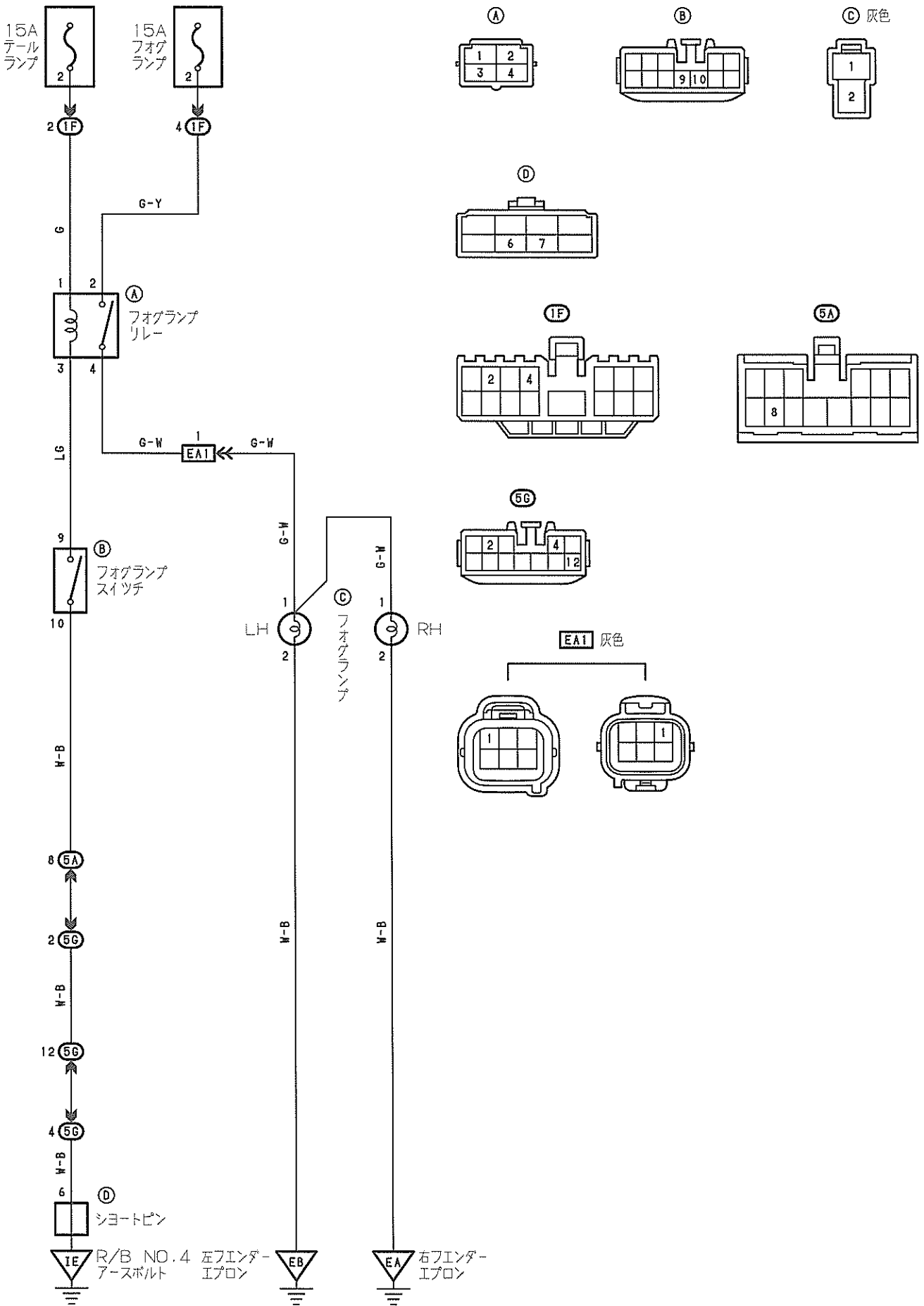

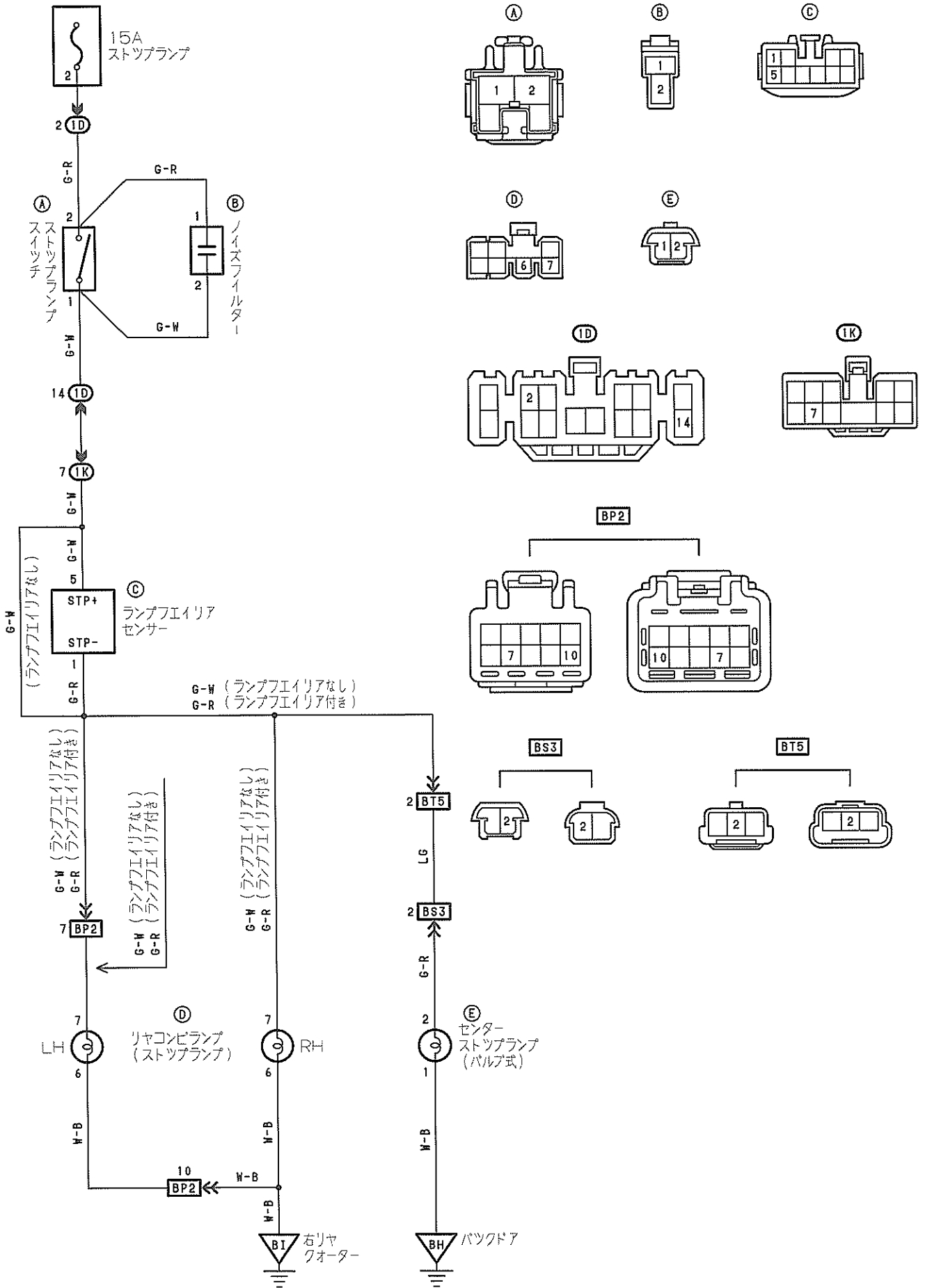

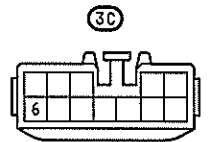
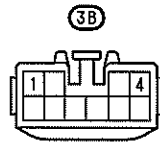
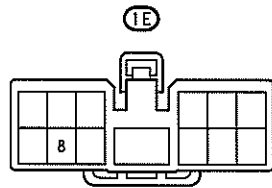
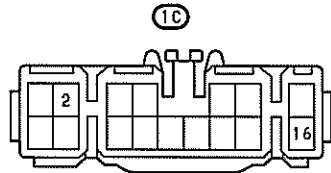
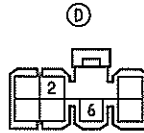
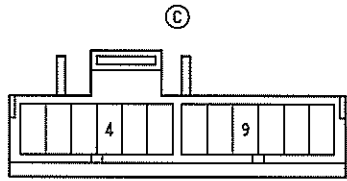
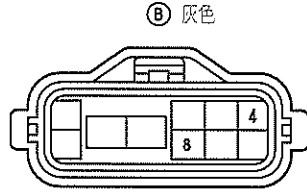
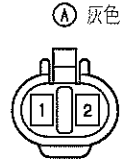
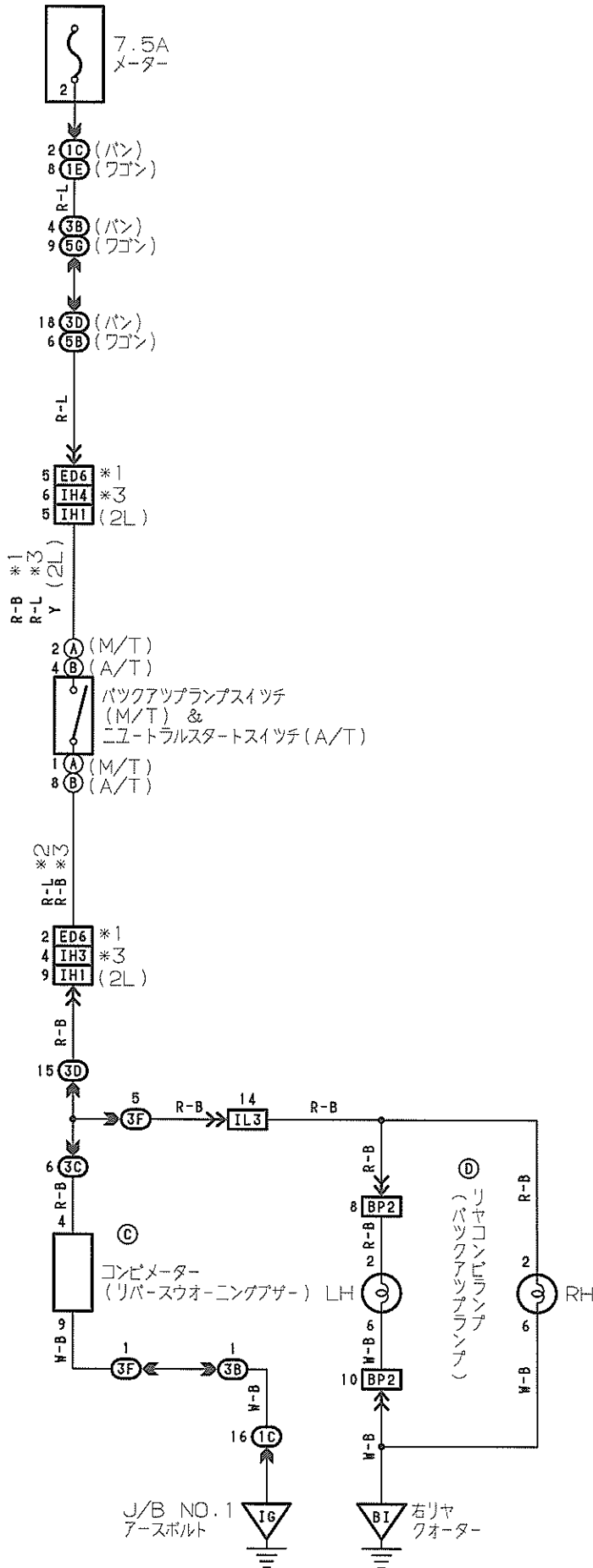

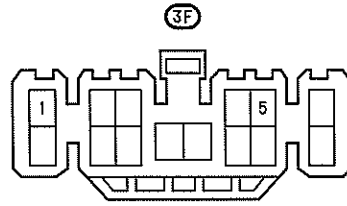
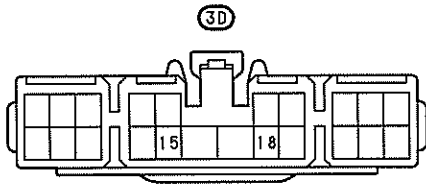

ED6

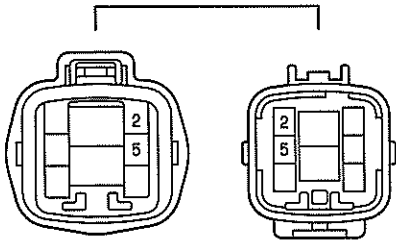

IH1

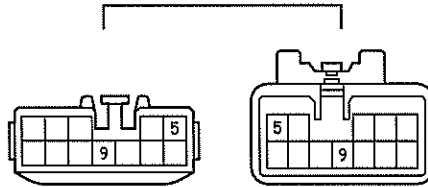

IH3 濃灰色

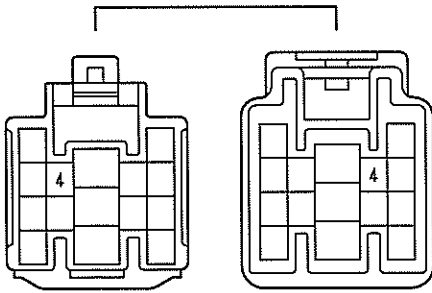

IH4

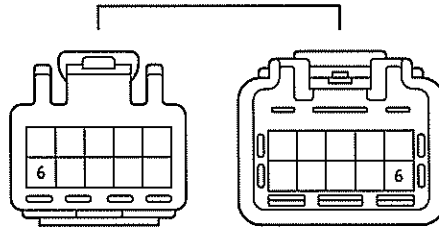

IL3 濃灰色

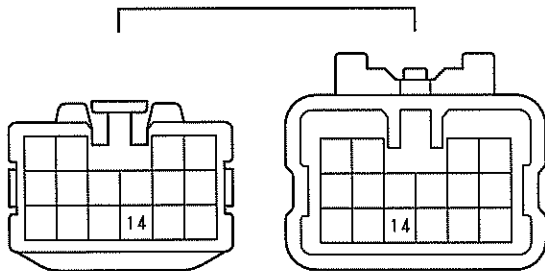

BP2

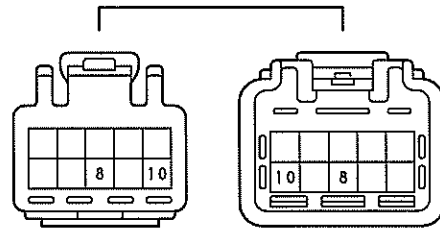

# リヤライトウオーニング(1G-FE)

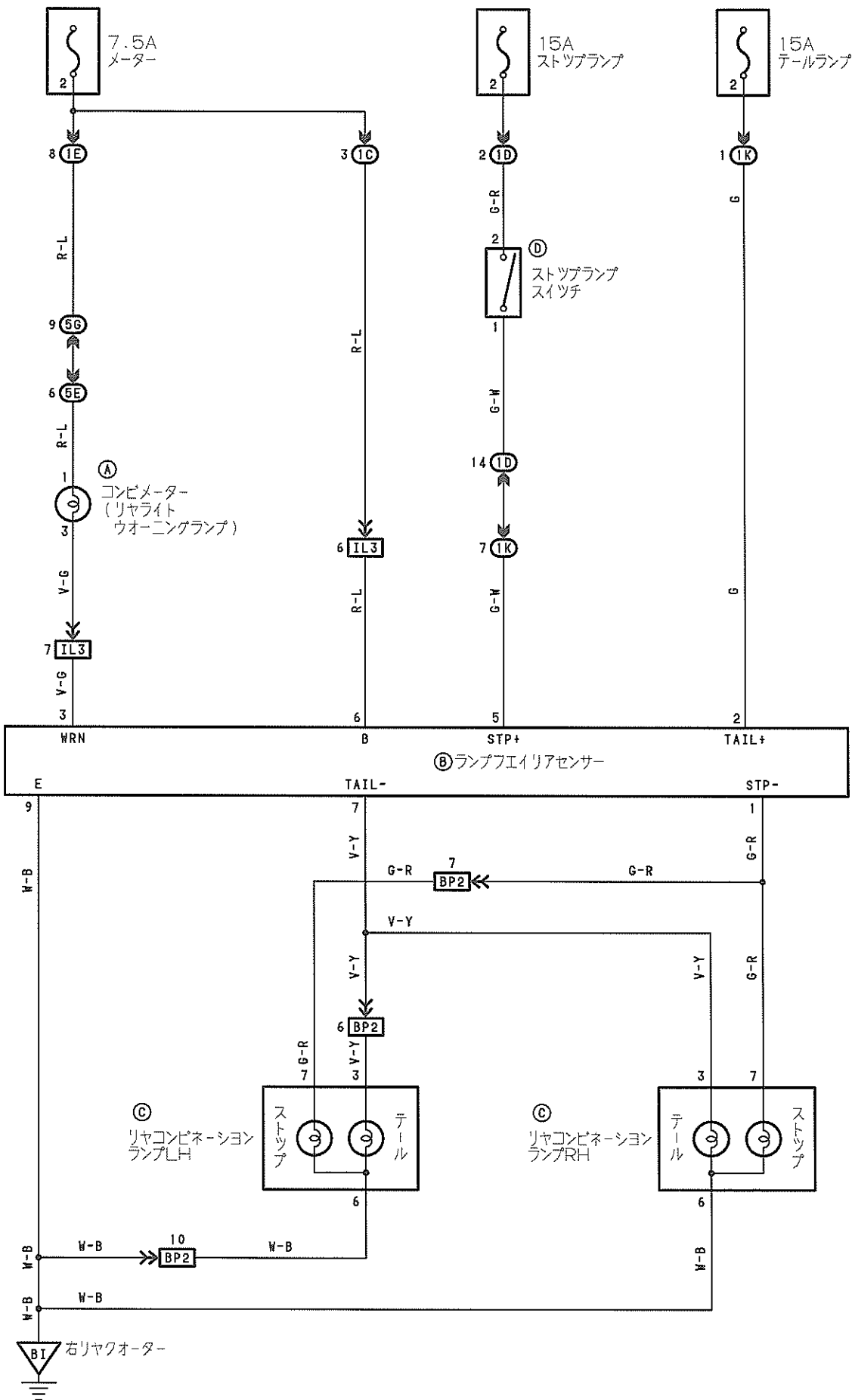

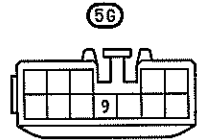
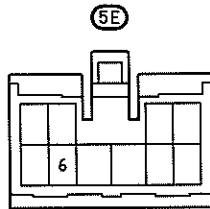
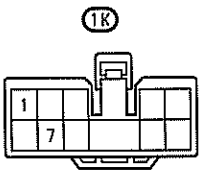
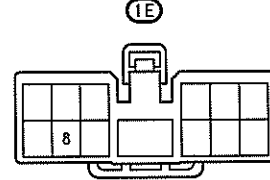
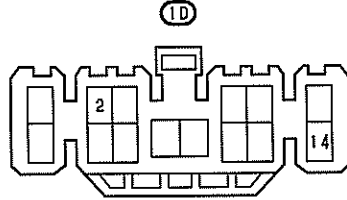
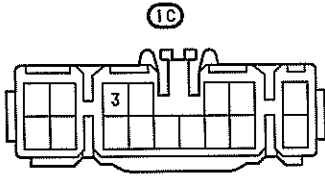
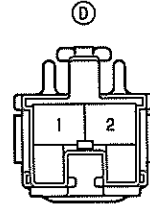
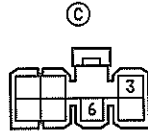
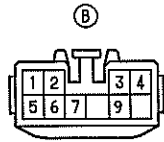
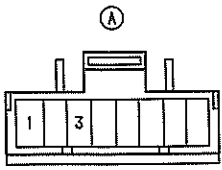

IL3 濃灰色

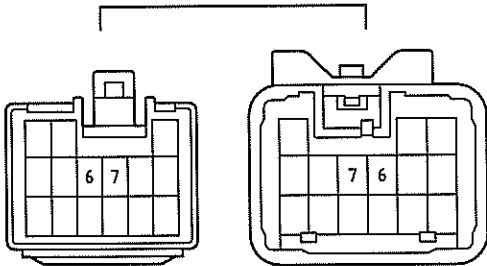

BP2

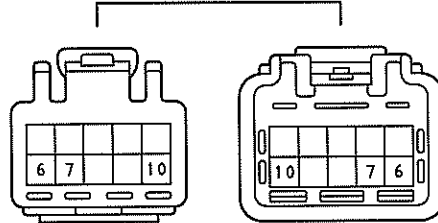

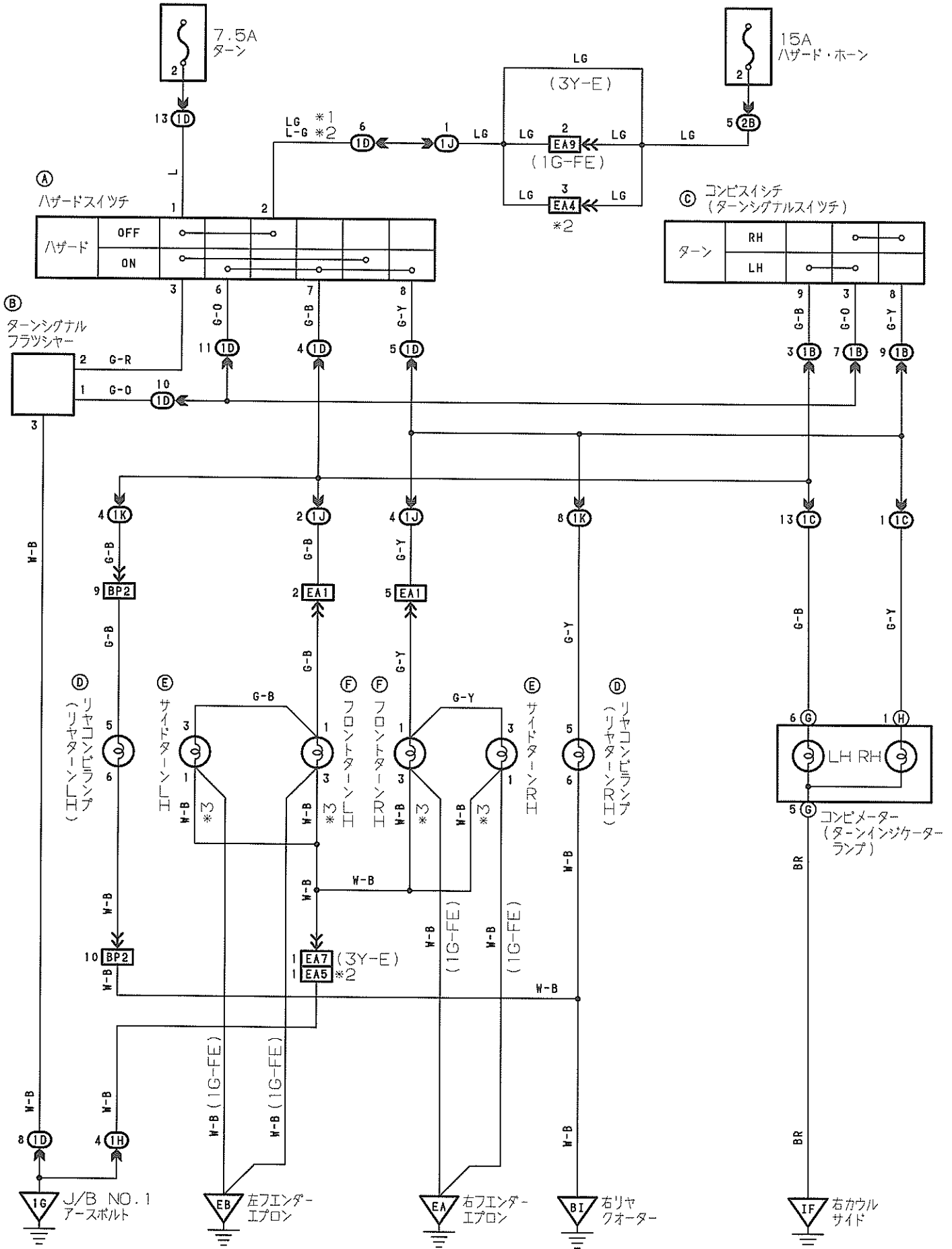

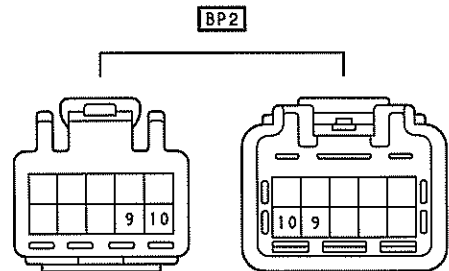
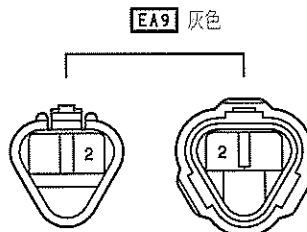
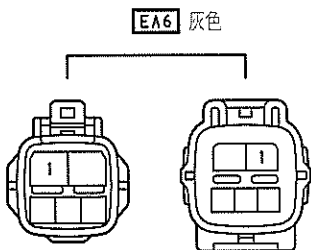
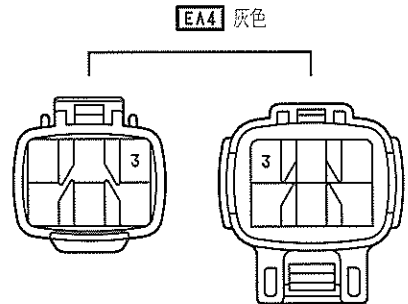
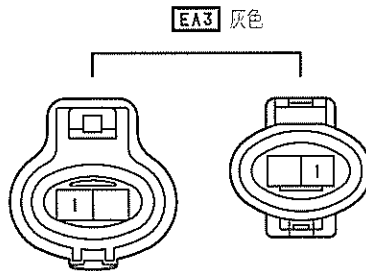
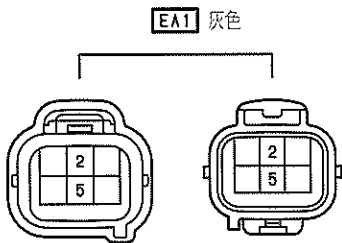
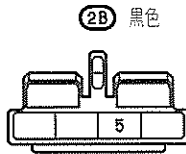
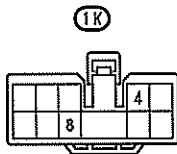
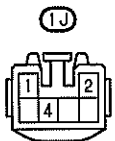
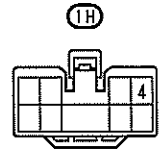
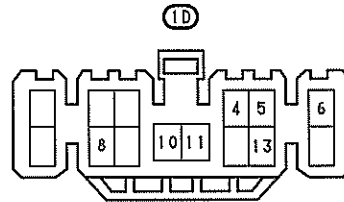
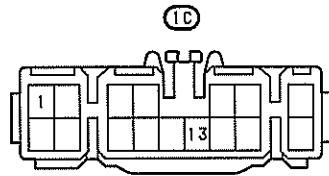
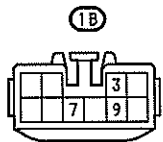
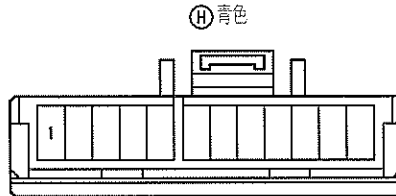
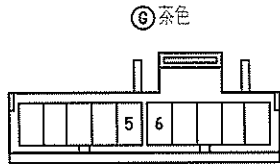
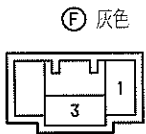
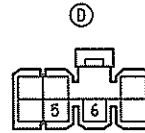
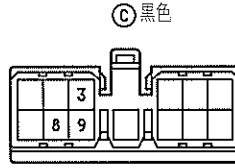
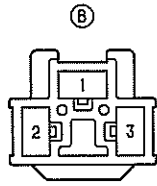
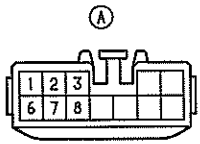

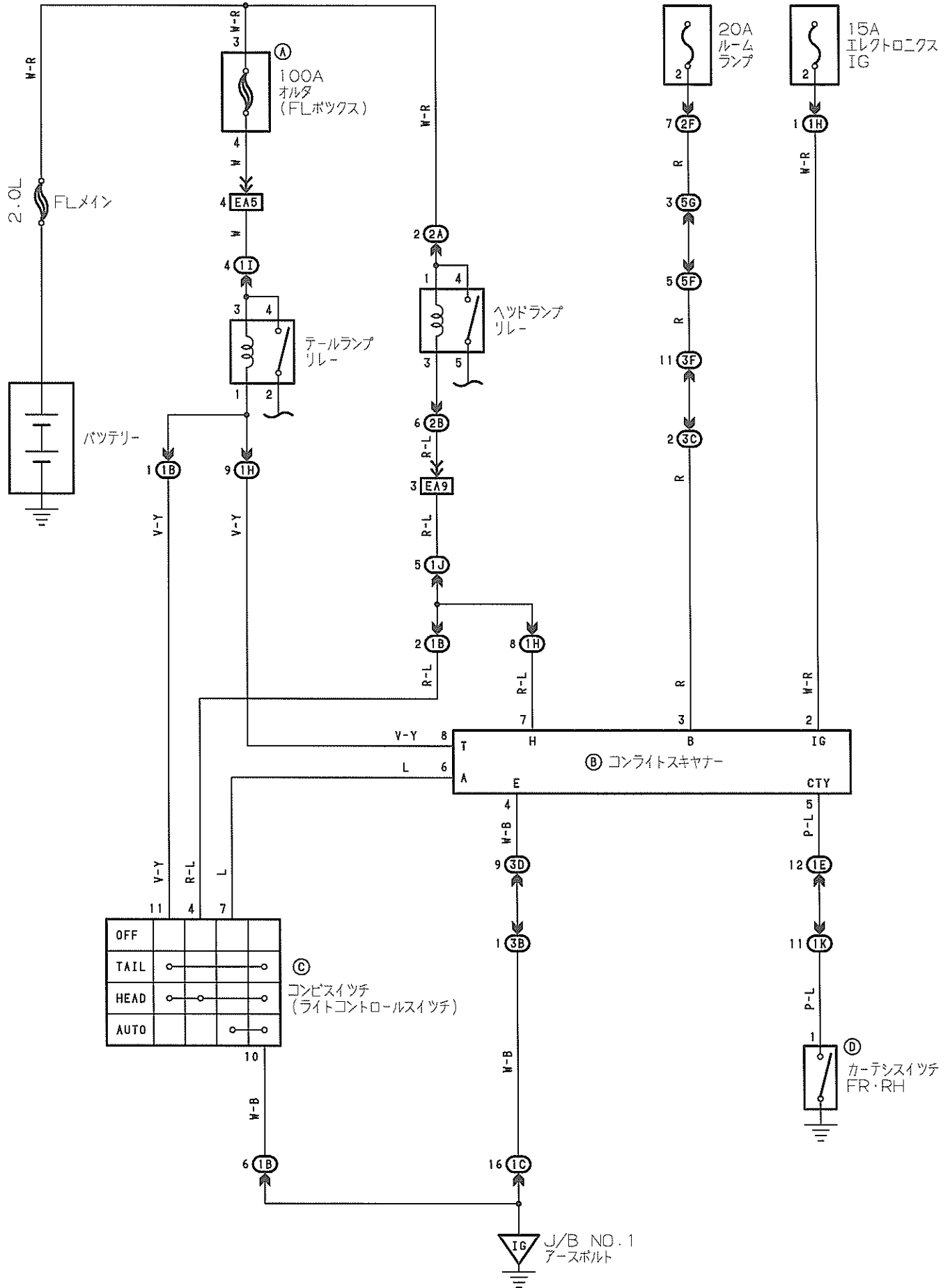

① 黒色

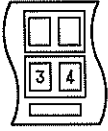

②

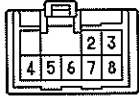

③ 黒色

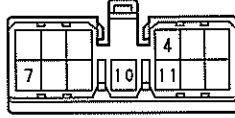

④



⑤ ⑥



⑦

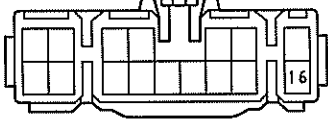

⑧

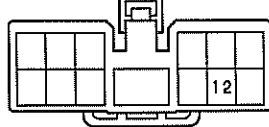

⑨

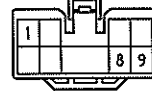

⑩



⑪ 黒色



⑫

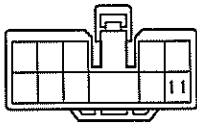

⑬ 黒色



⑭ 黒色

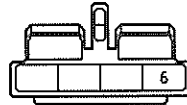

⑮ 濃灰色

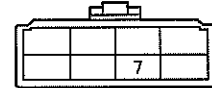

⑯ ⑰

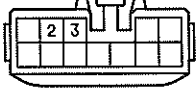

⑱

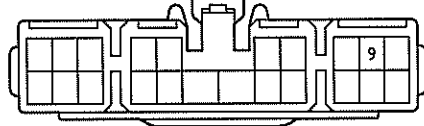

⑲ ⑳

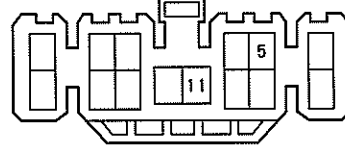

㉑ 黒色

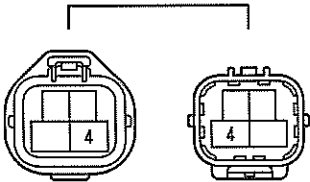

㉒ 灰色

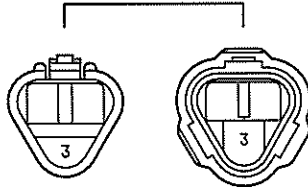

- \*1: 3Y-E
- \*2: 除く3Y-E
- \*3: ランプフェイリアなし
- \*4: ランプフェイリア付き

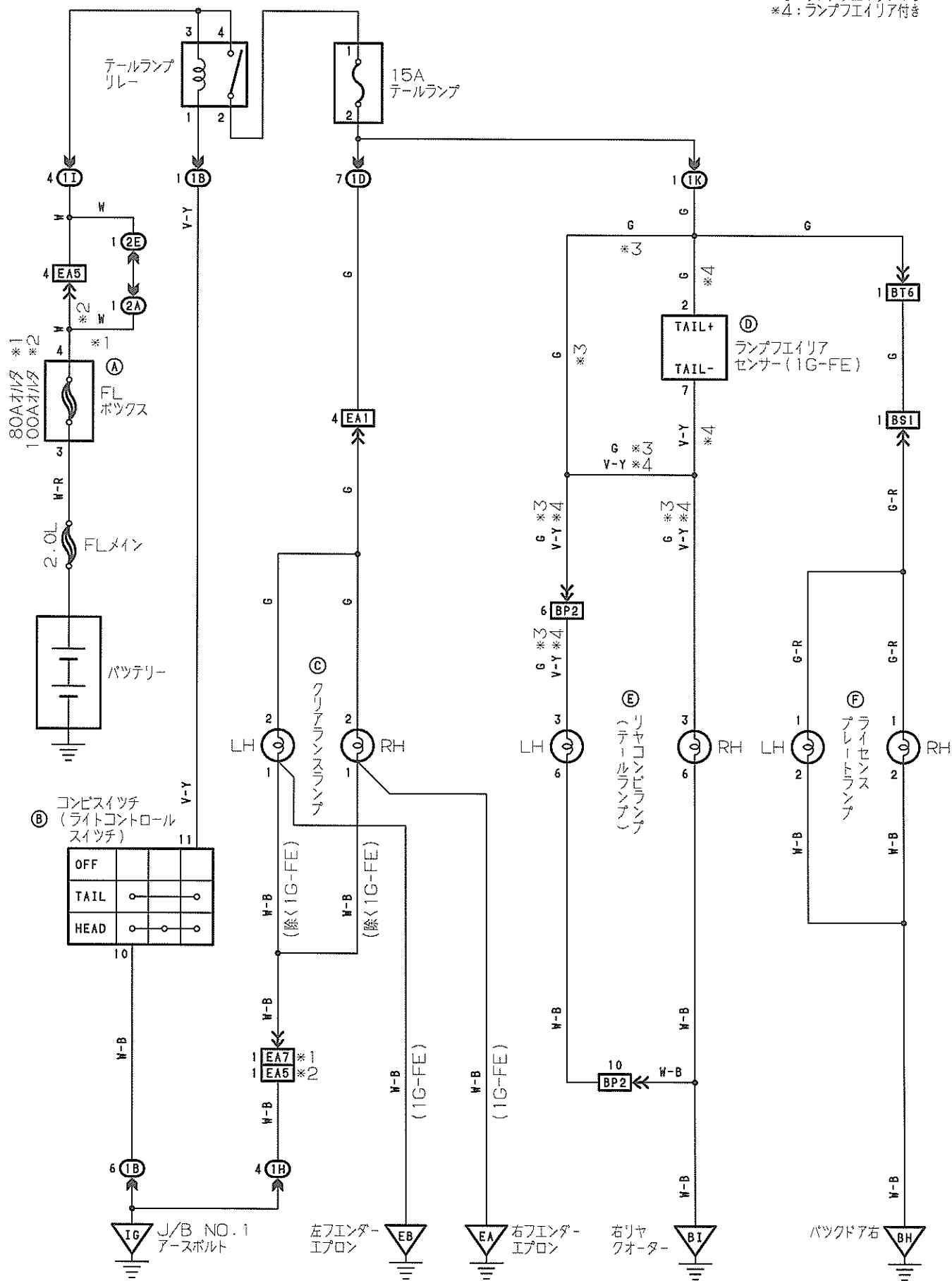

Ⓐ 黒色



Ⓑ 黒色

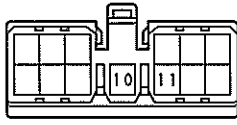

Ⓒ 灰色

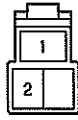

Ⓓ

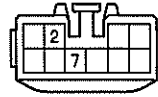

Ⓔ

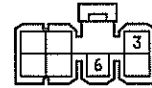

Ⓕ



ⓑ

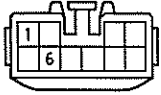

ⓓ

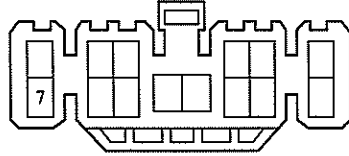

ⓓ

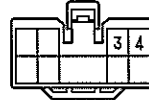

ⓓ

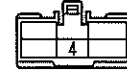

ⓓ

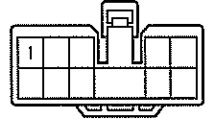

Ⓐ 黒色



Ⓐ 灰色



EA1 灰色

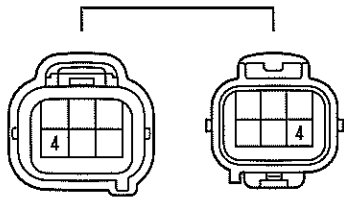

EA5 黒色

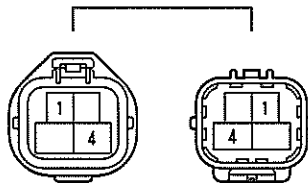

EA7 灰色

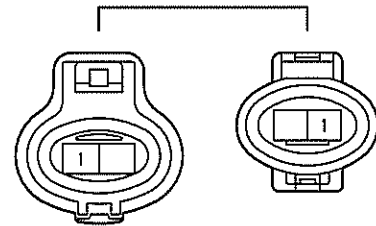

BP2

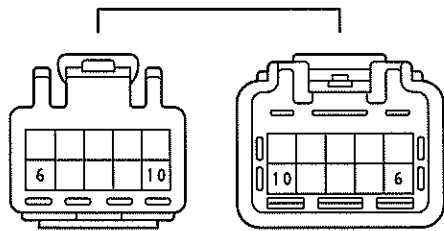

BS1

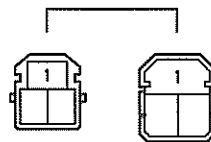

BT6

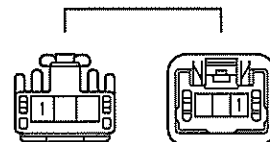

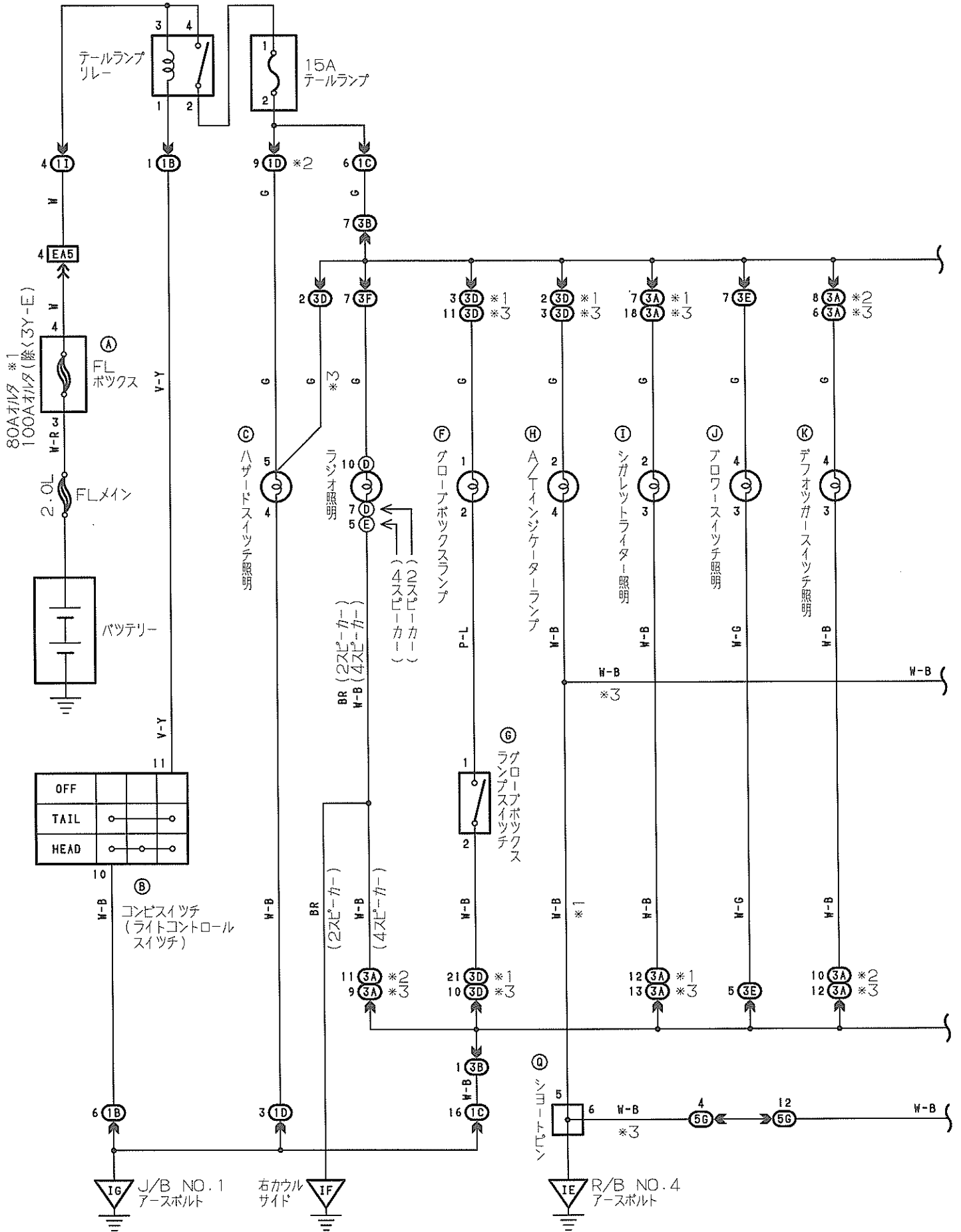

- \*1: 3Y-E
- \*2: 3Y-E, 2L
- \*3: 1G-FE

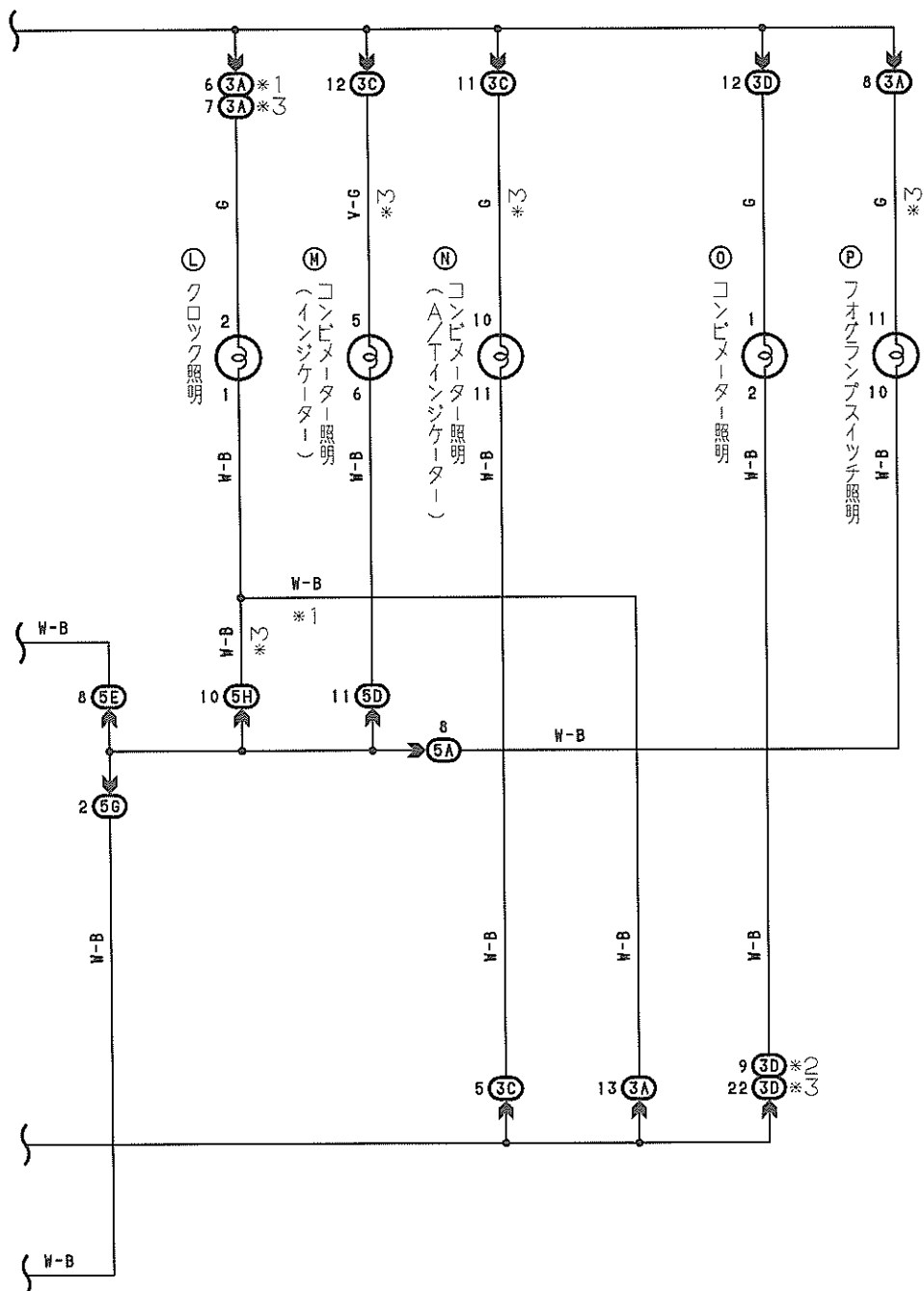

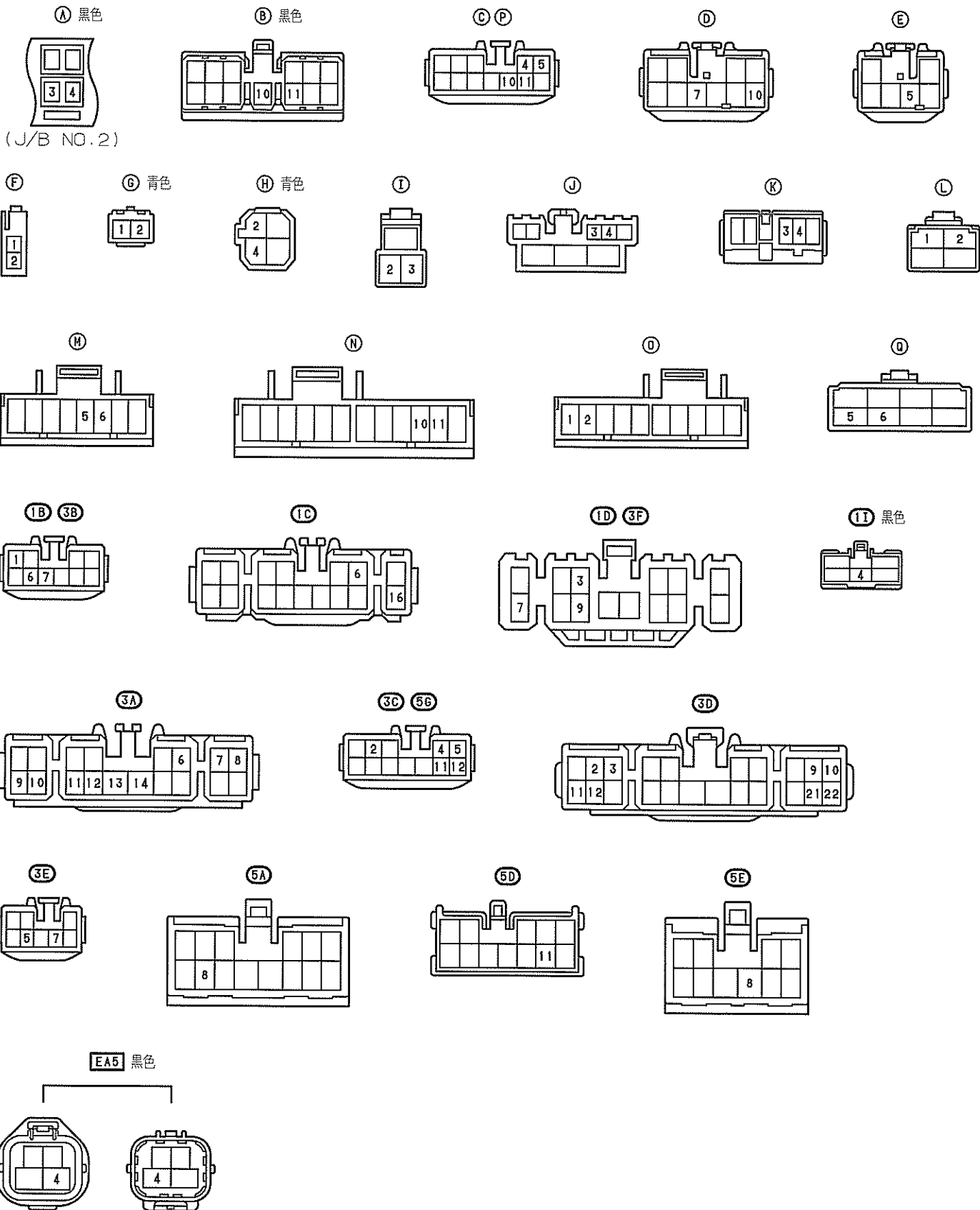

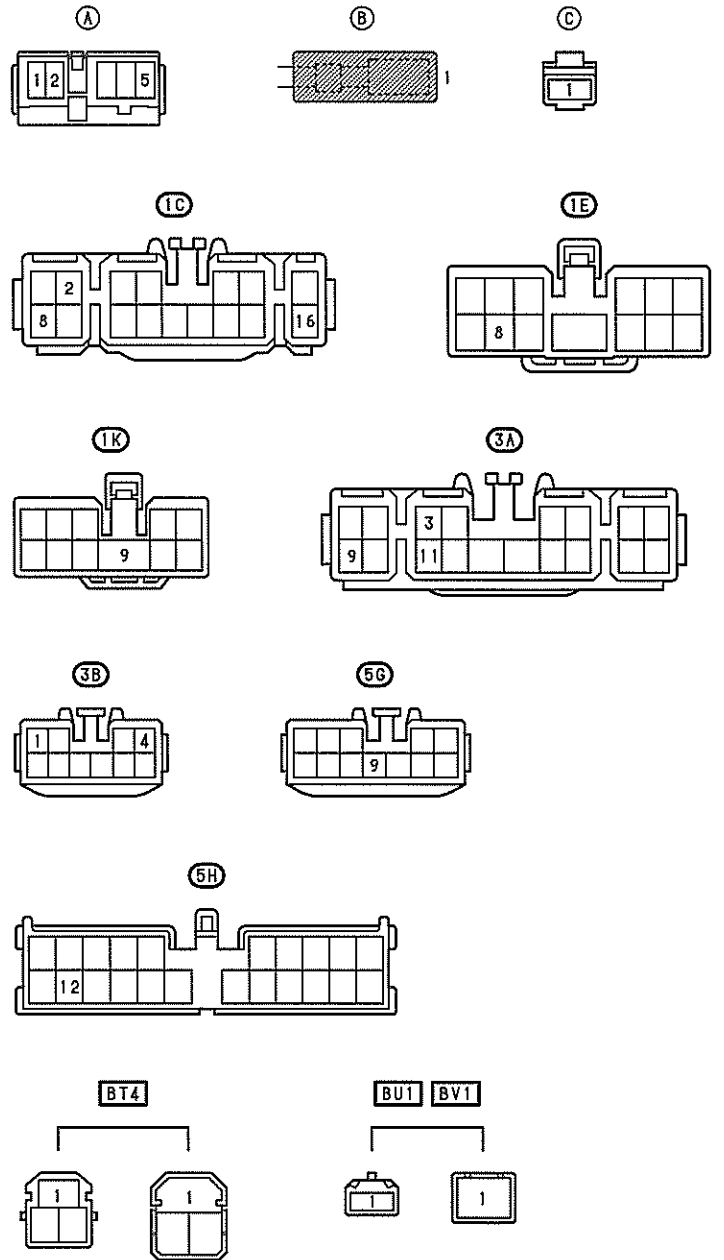
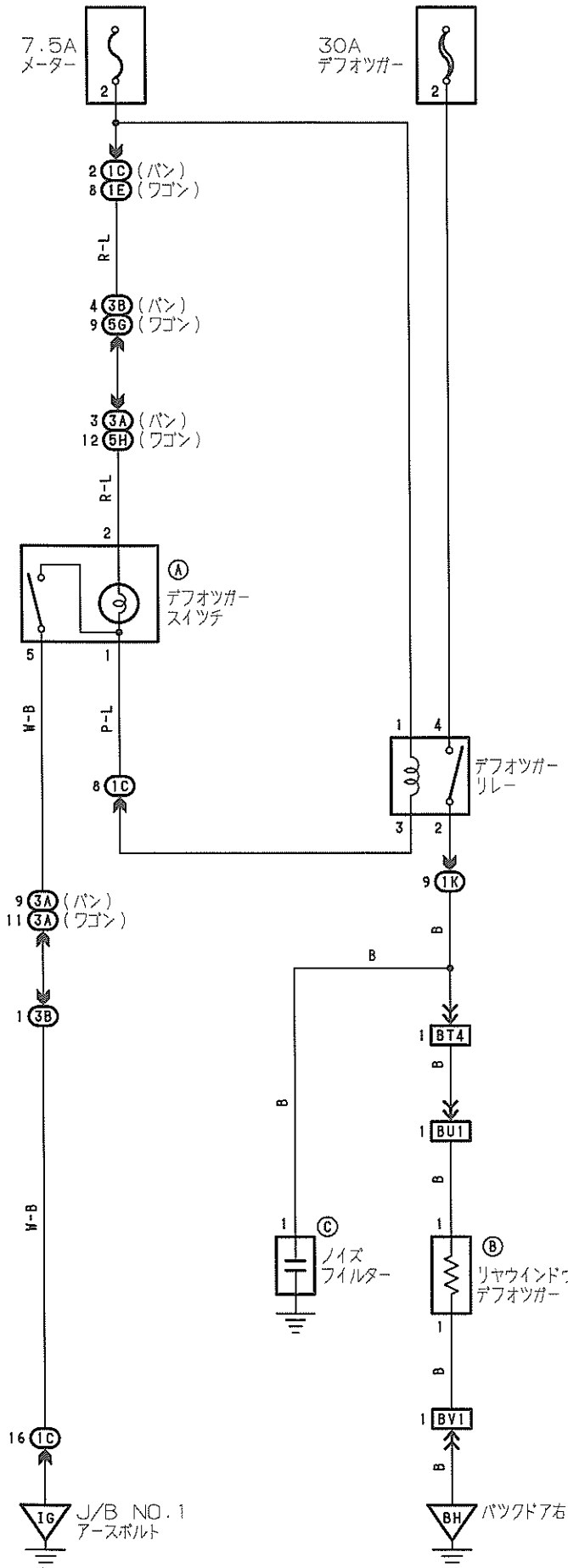

# パワーウィンドウ

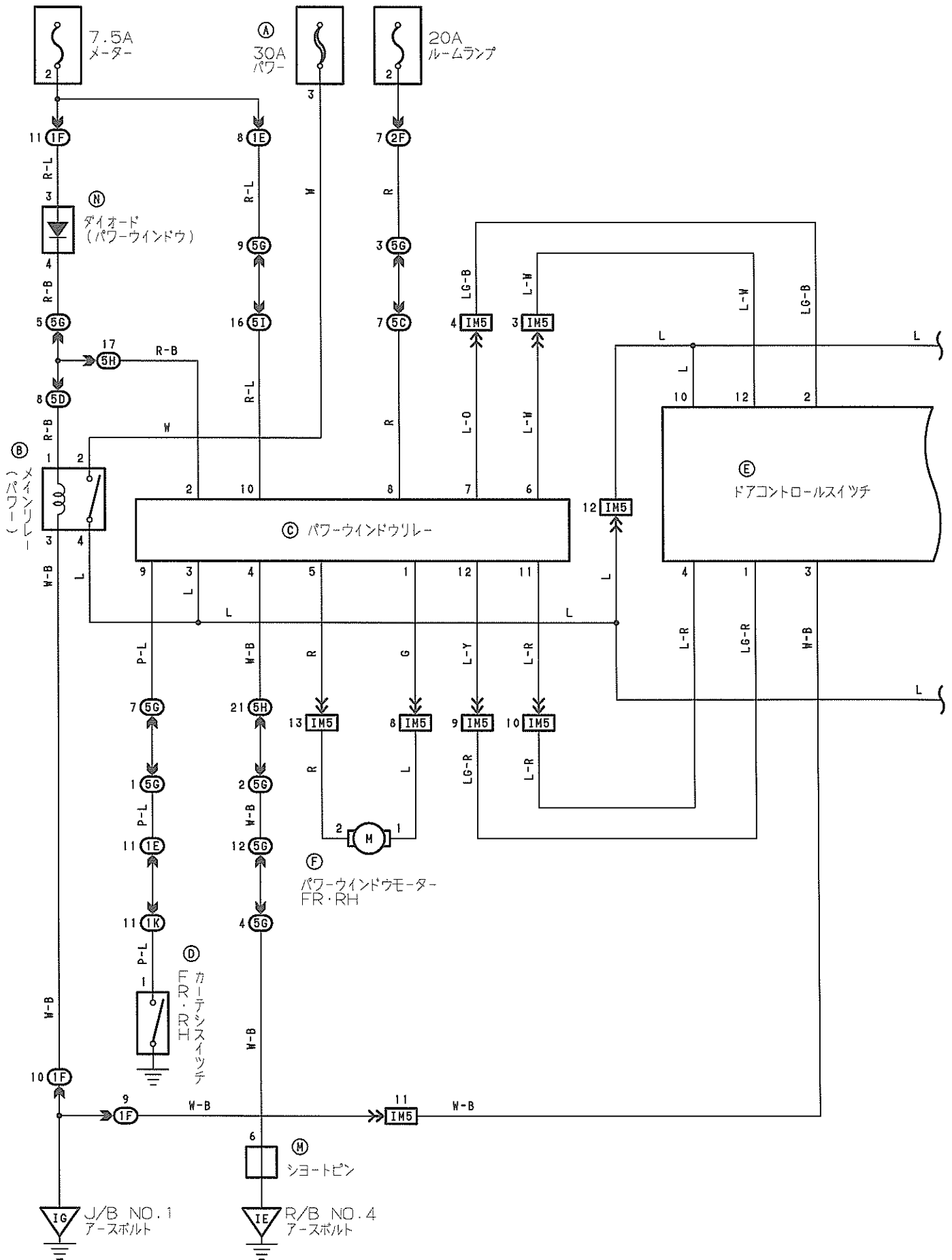



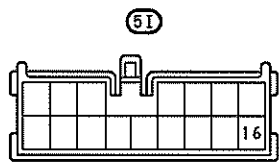
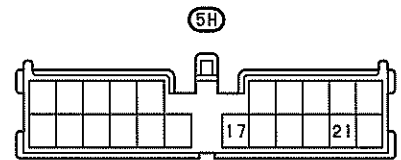
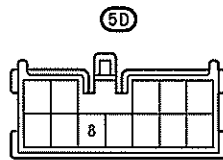
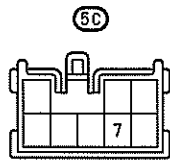
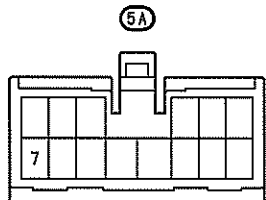
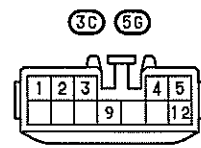
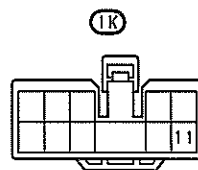
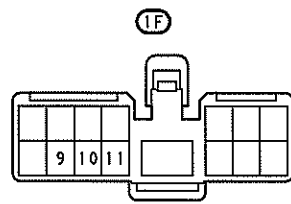
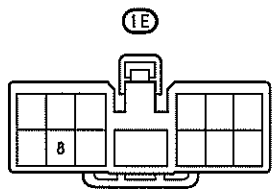

I11 青色

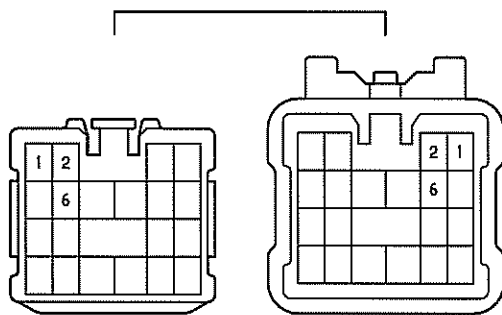

IJ2 濃灰色

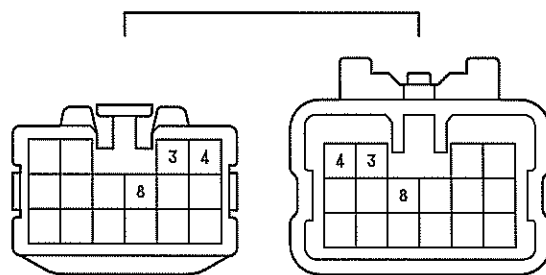

IM5 青色

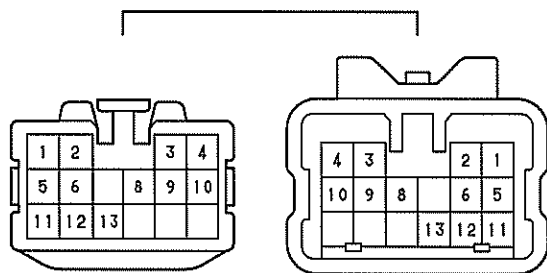

IN1

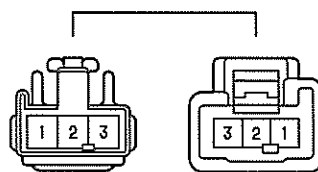

B01 B01 青色

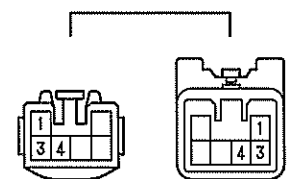

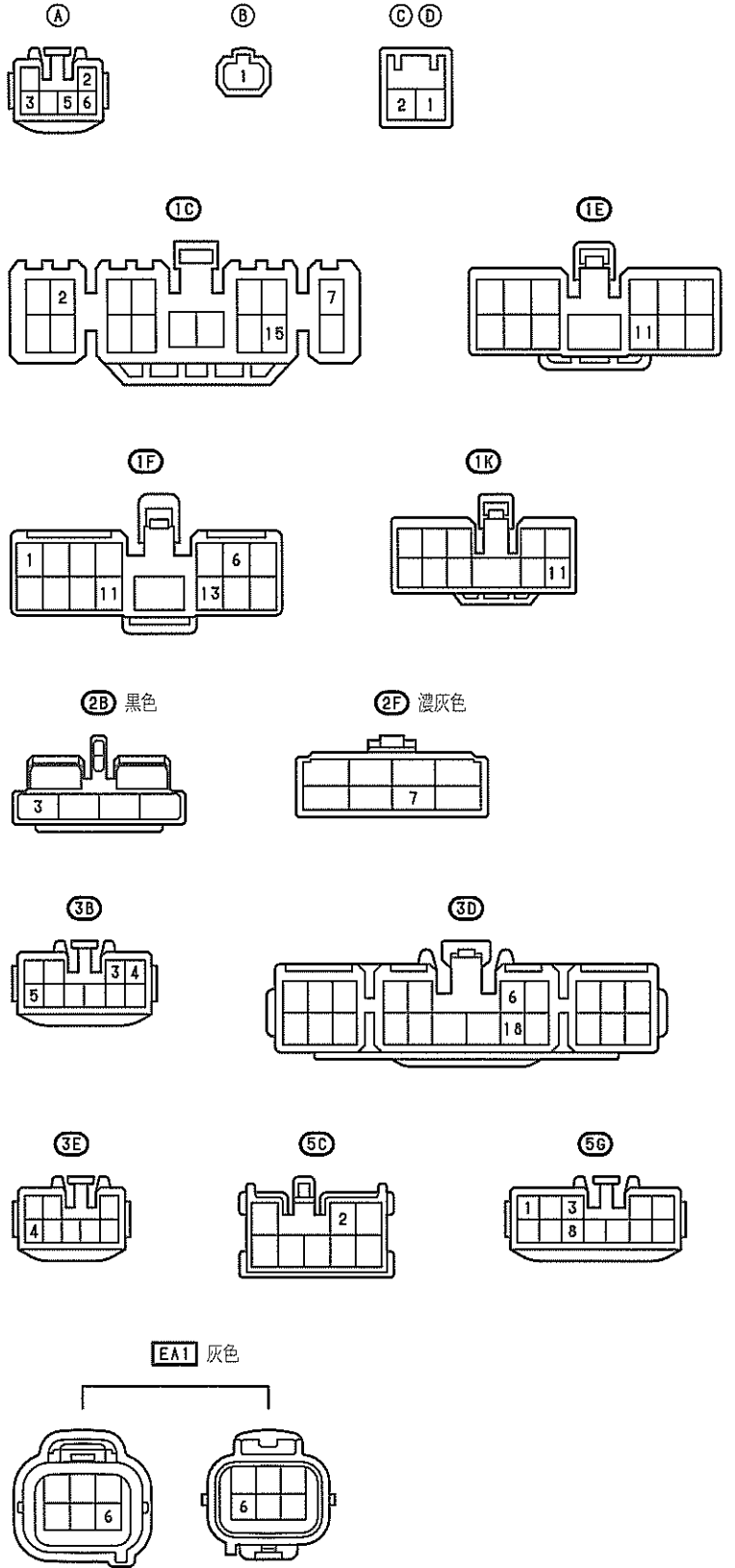
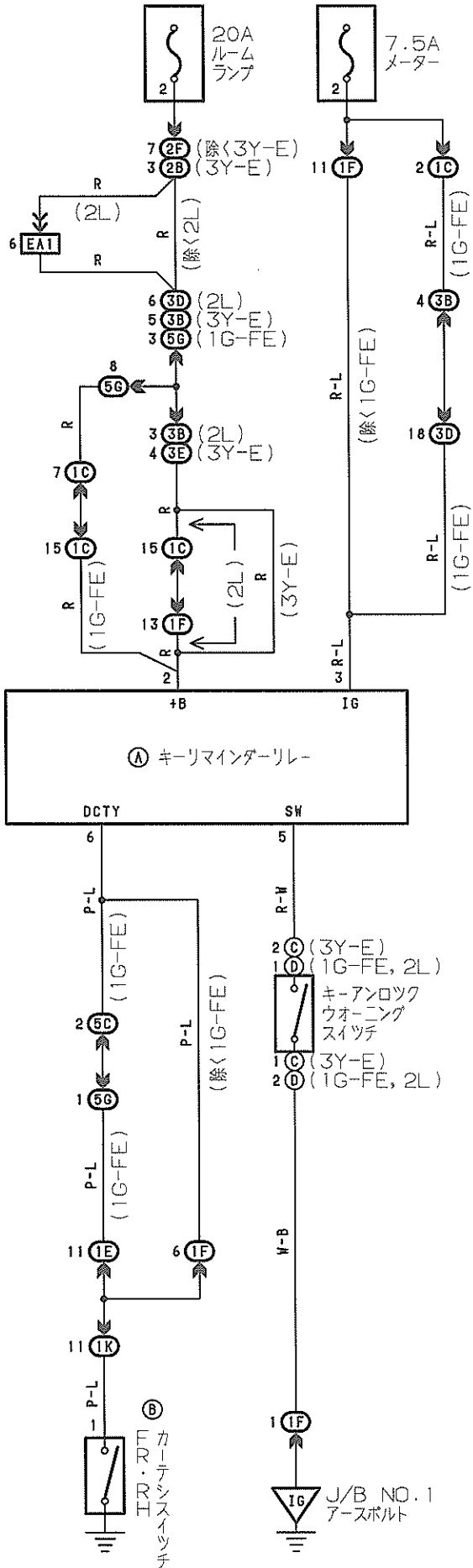



Ⓐ 黒色

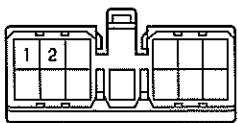

Ⓑ 黒色

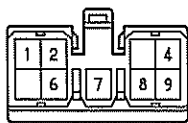

Ⓒ

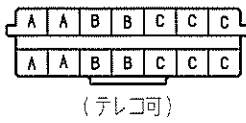

Ⓓ 黒色

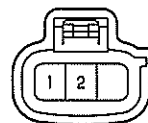

Ⓔ 黒色

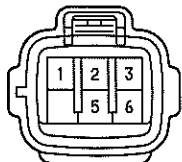

Ⓕ

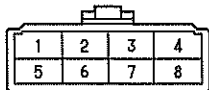

Ⓖ

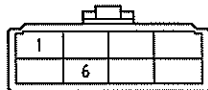

⓫

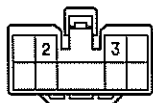

⓪F

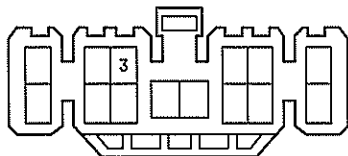

⓪B

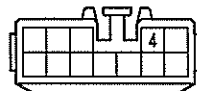

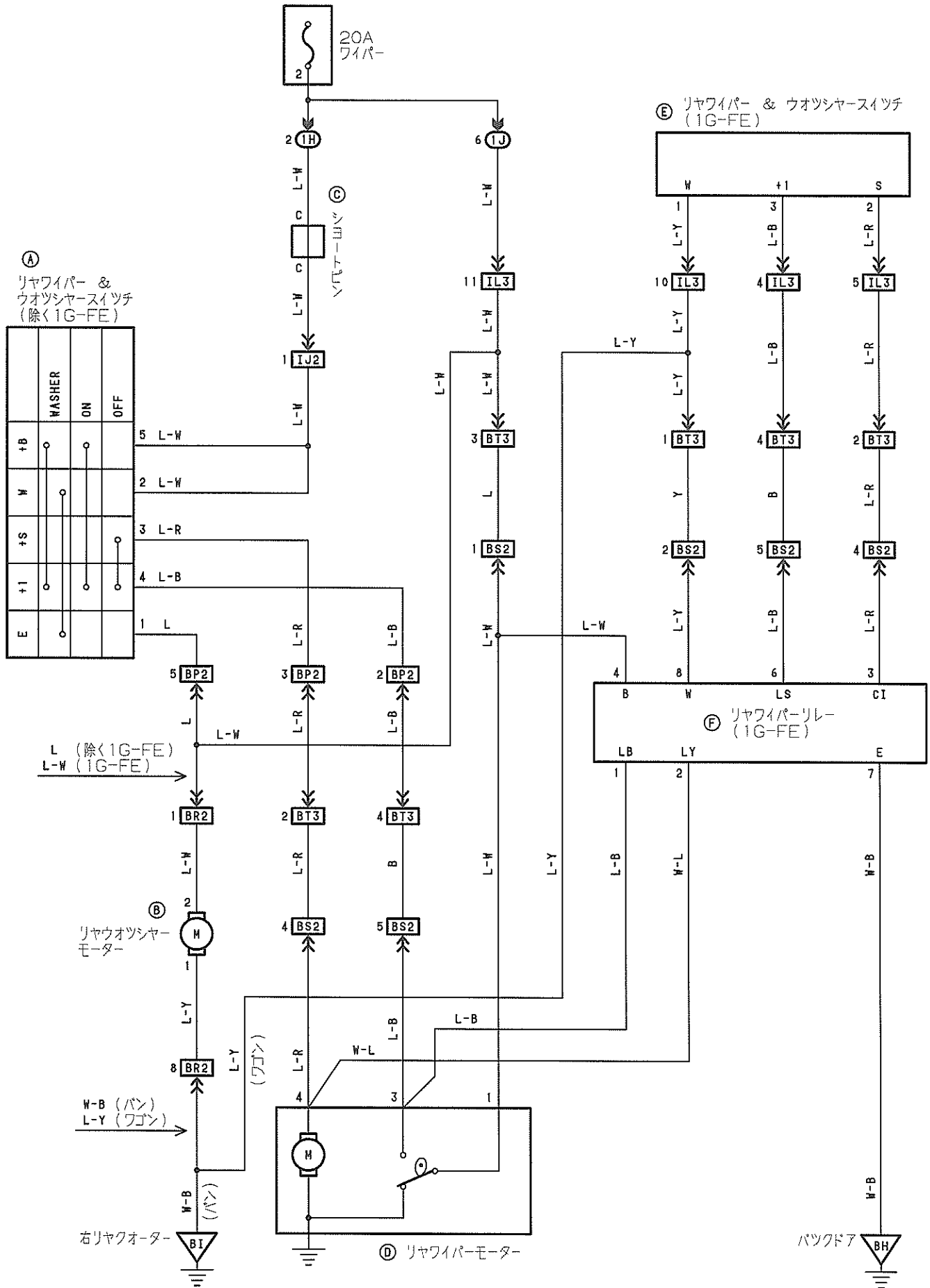

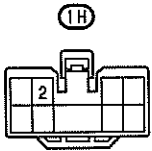
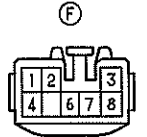
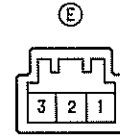
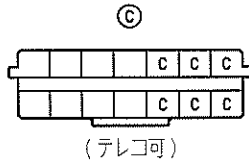
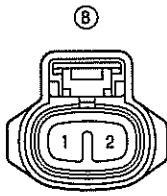
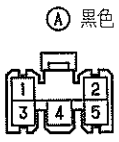

ⒾⒿ2 濃灰色

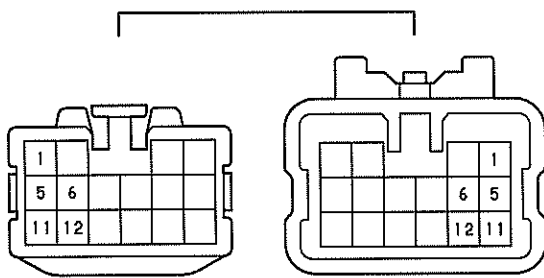

ⒾⒿ3 濃灰色

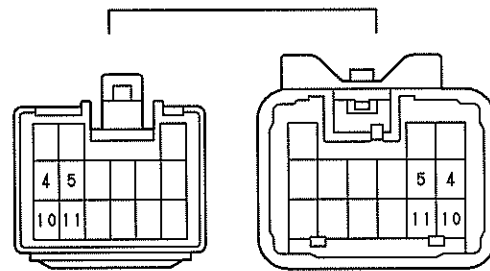

ⒷⒾ2

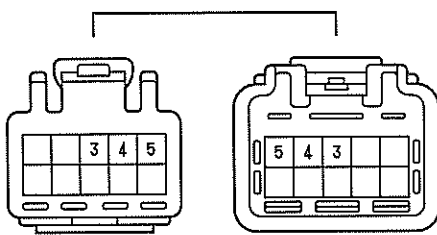

ⒷⒾ2

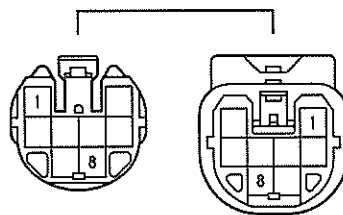

ⒷⒾ2

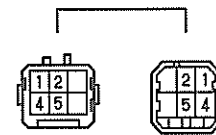

ⒷⒿ3

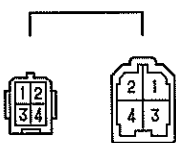

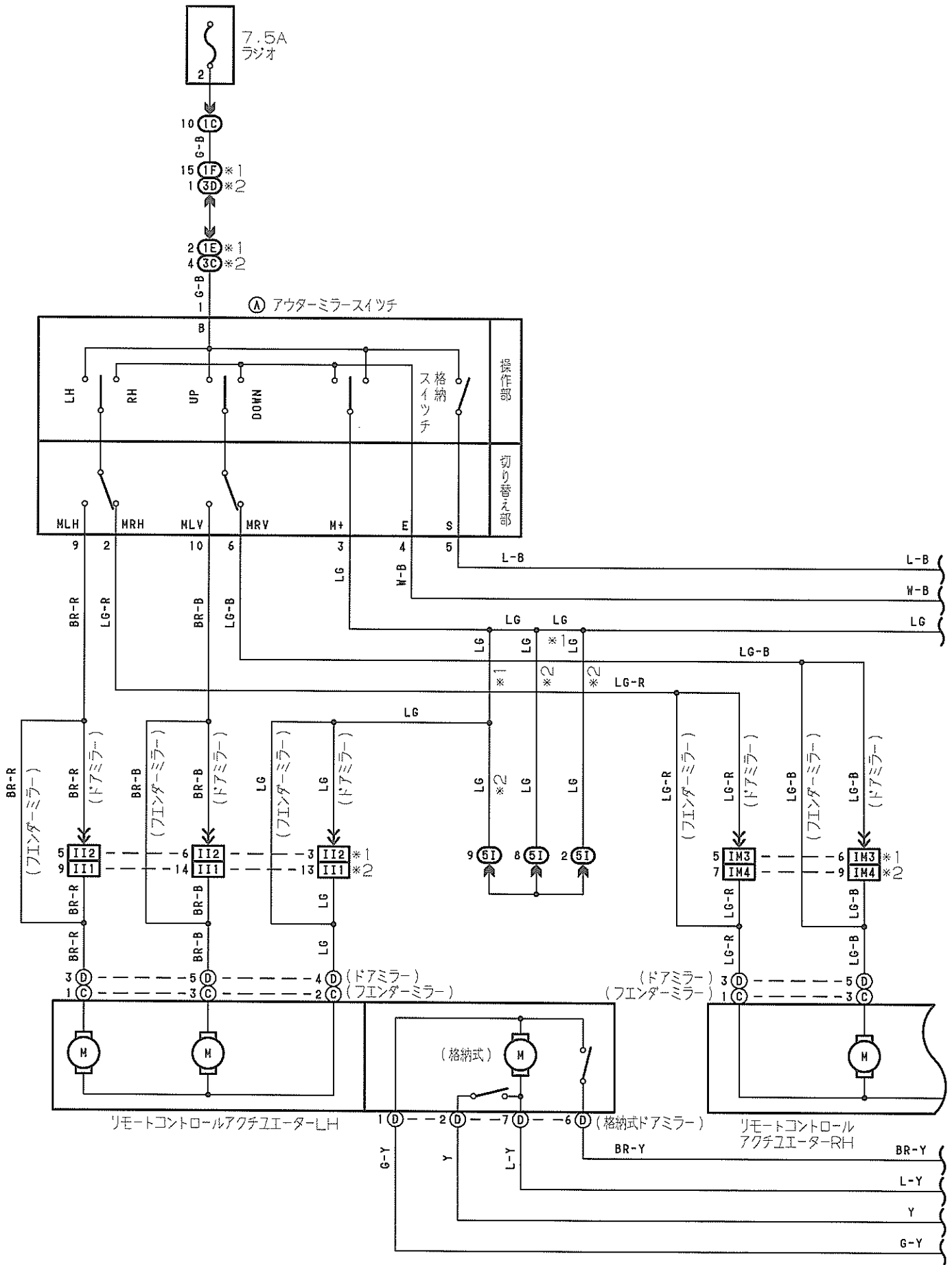

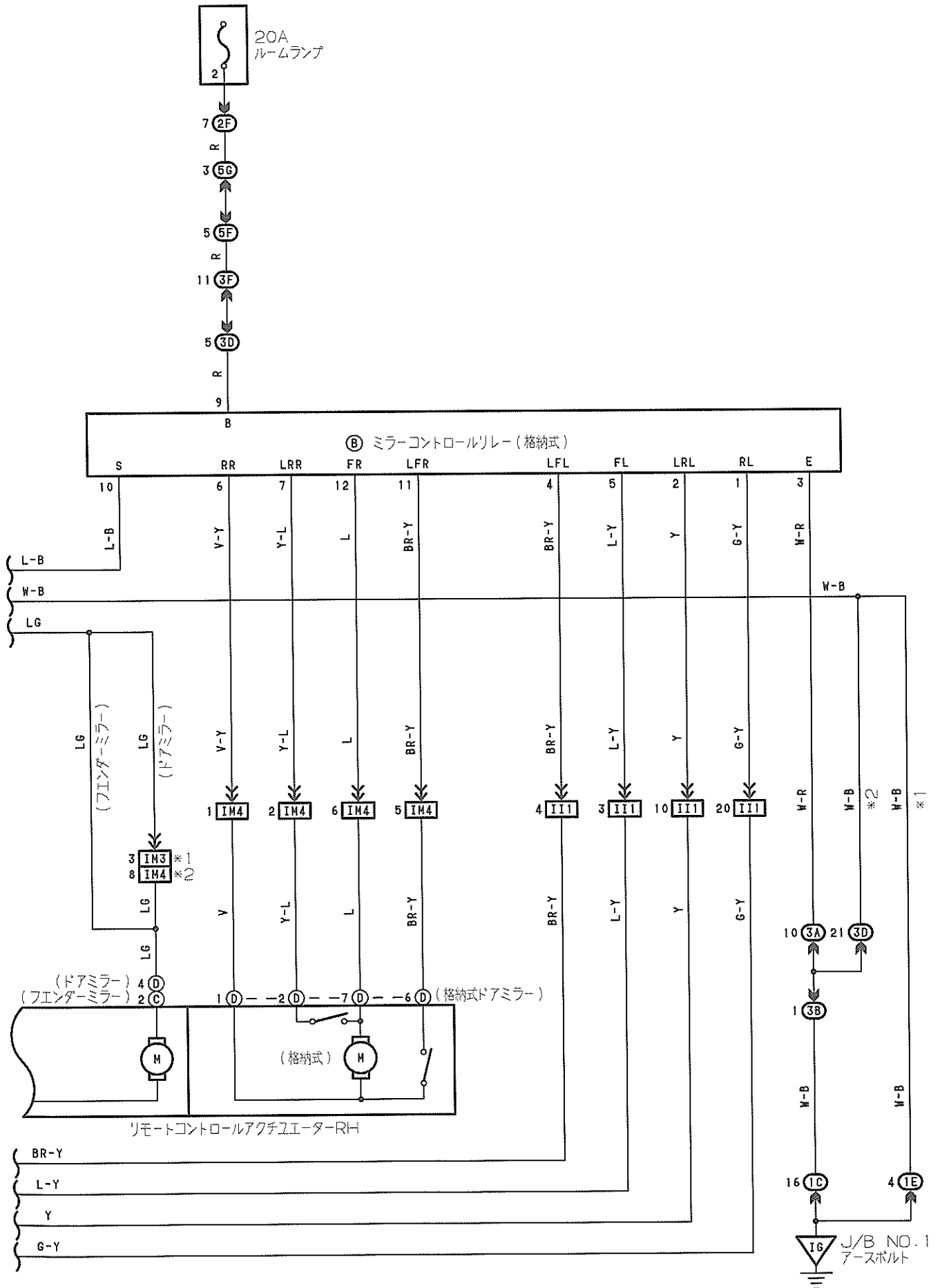

① 青色

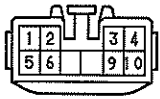

②

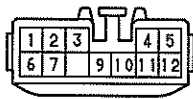

③



④

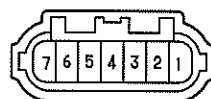

⑩C

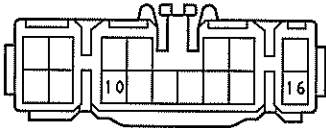

⑩E

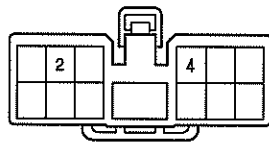

⑩F

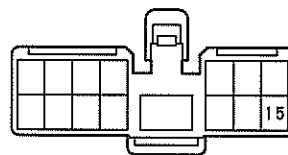

⑫F 濃灰色

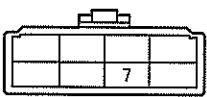

⑬A

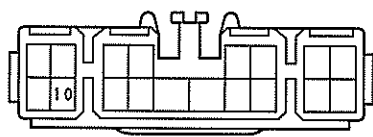

⑬B

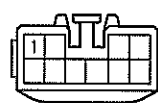

⑬C ⑬E

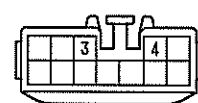

⑬D

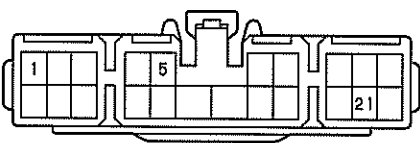

⑬F ⑬G

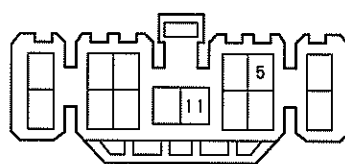

⑬I

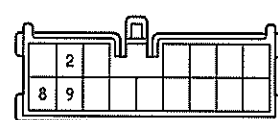

Ⅱ1 青色

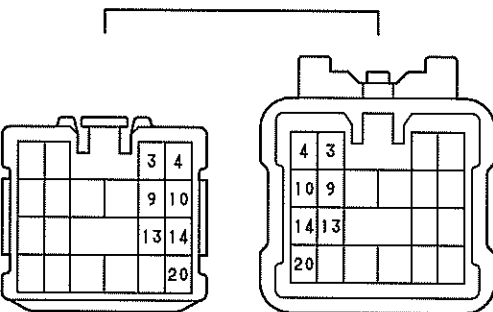

Ⅱ2 Ⅱ3 青色

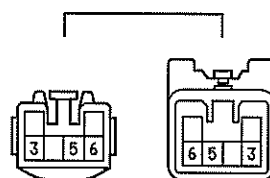

Ⅱ4 青色

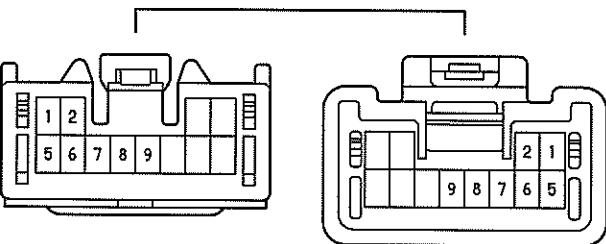



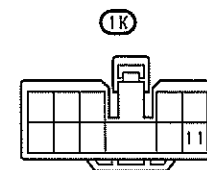
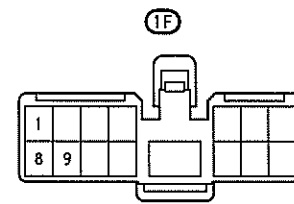
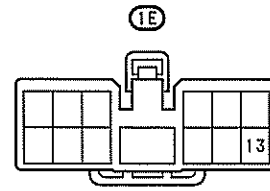
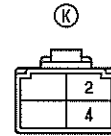
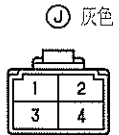
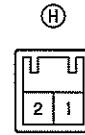
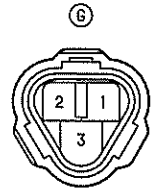
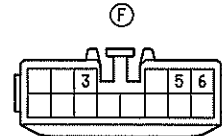
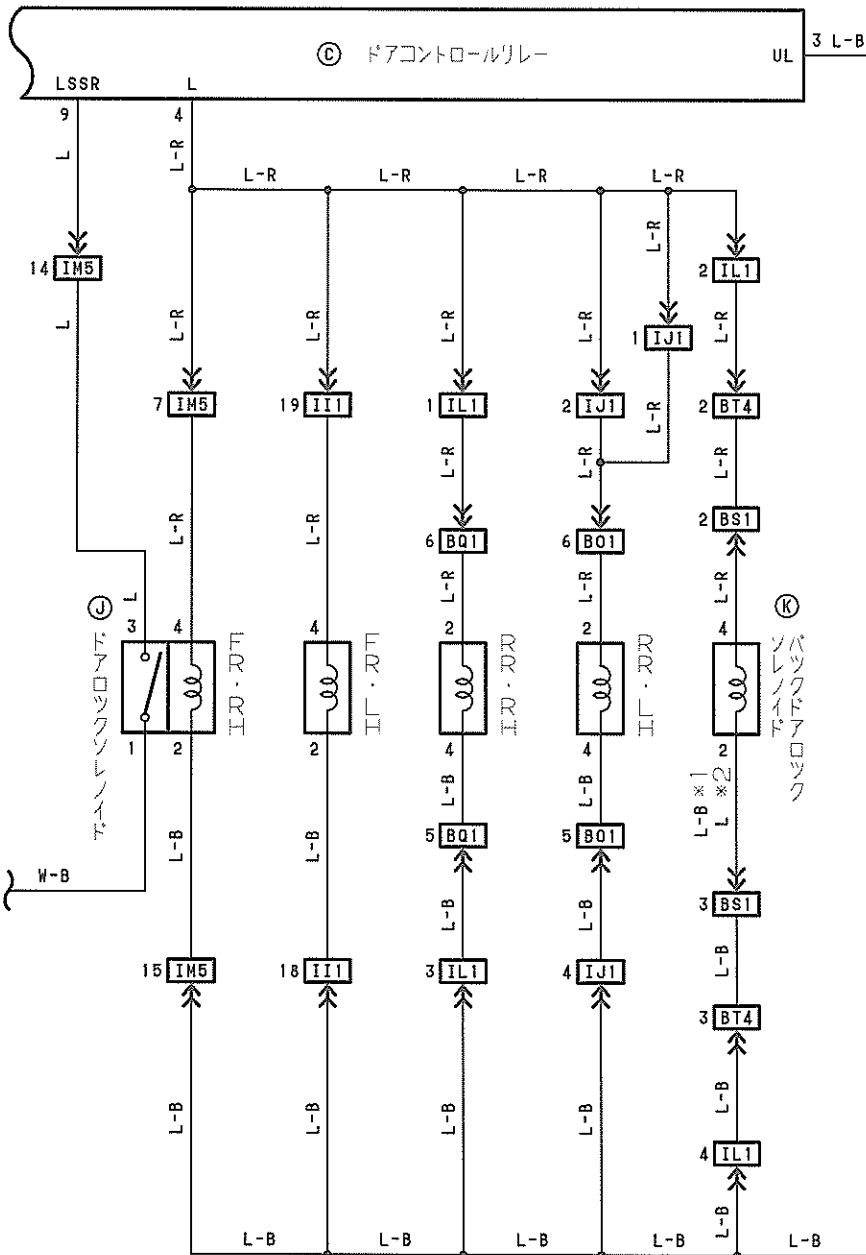
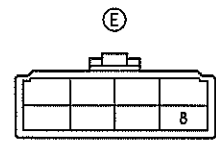
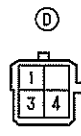
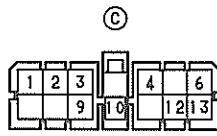
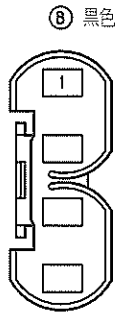
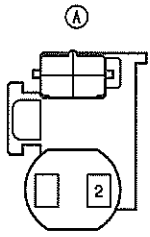

II1 青色

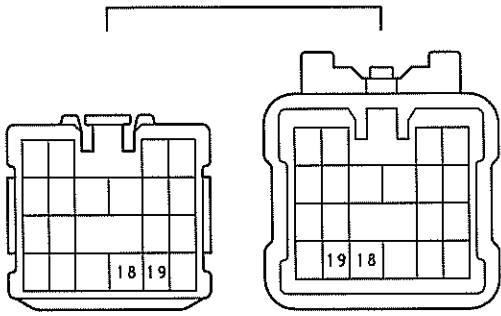

IJ1 IL1

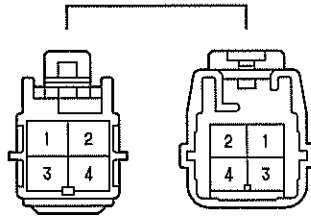

IJ2 濃灰色

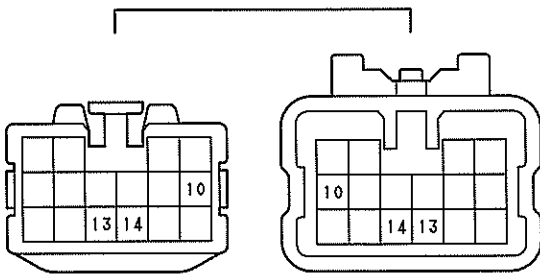

IN4 青色

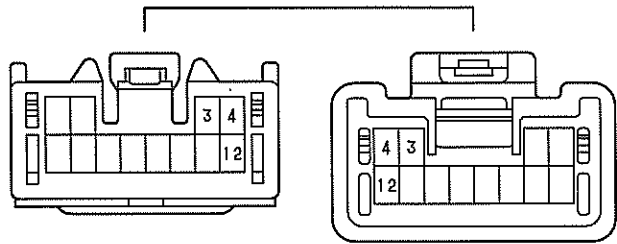

IM5 青色

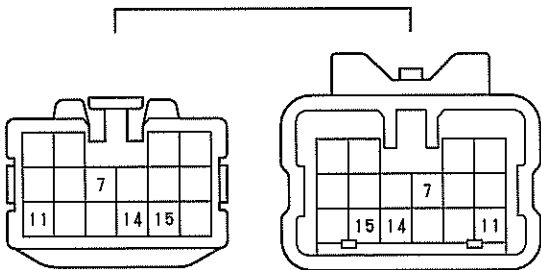

BQ1 BQ1 青色

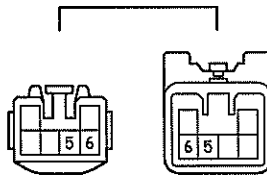

BS1 BT4

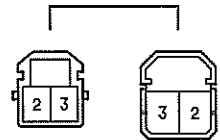



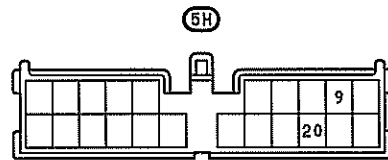
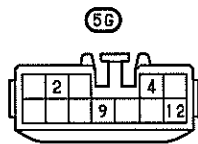
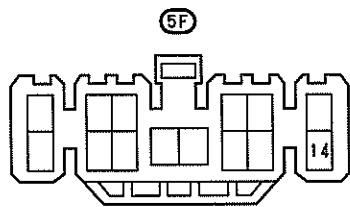
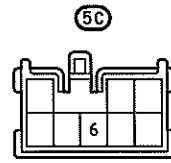
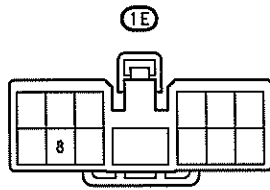
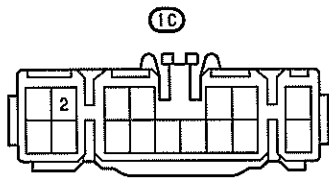
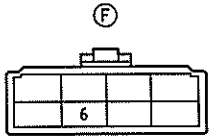
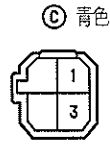
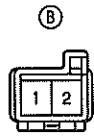
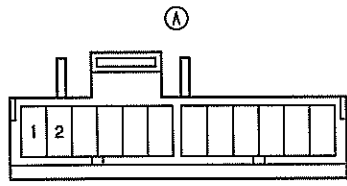

⑩H4 濃灰色

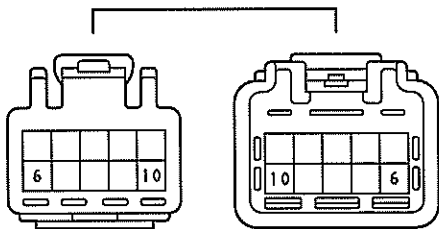

# シフトロック

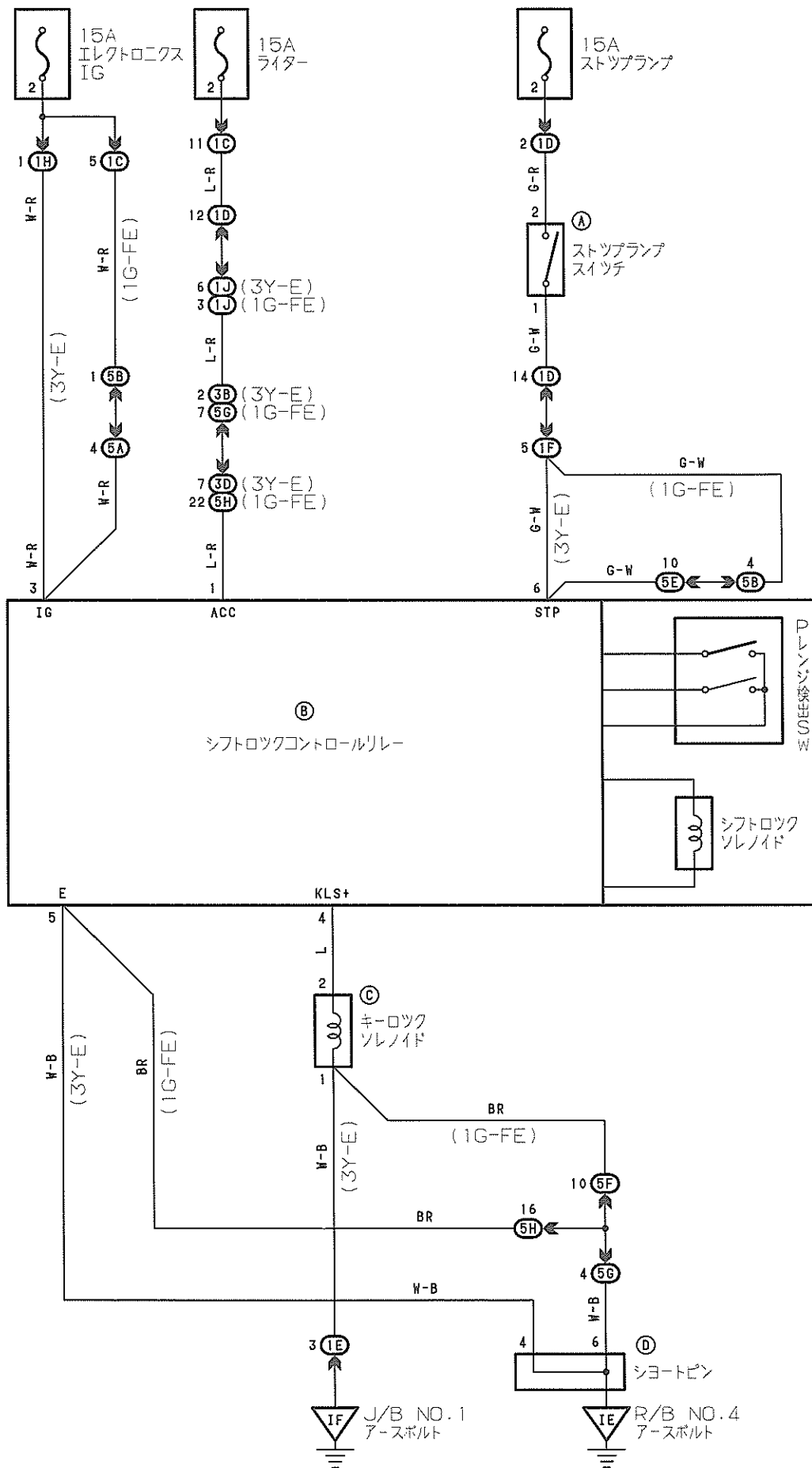

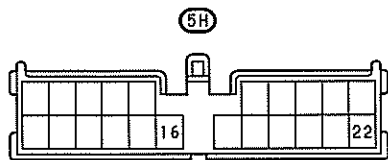
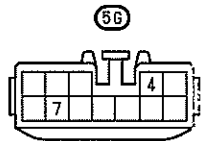
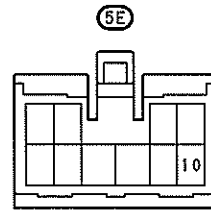
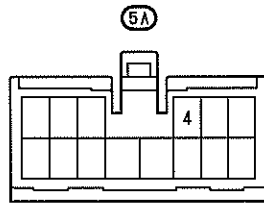
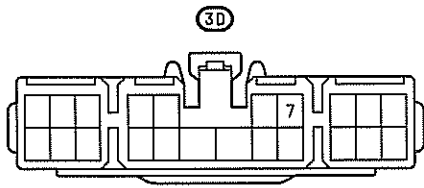
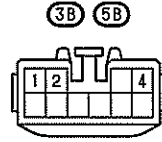
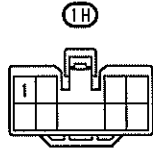
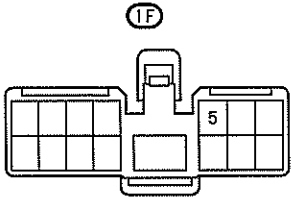
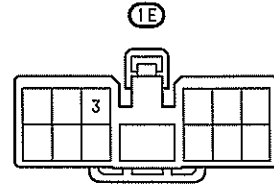
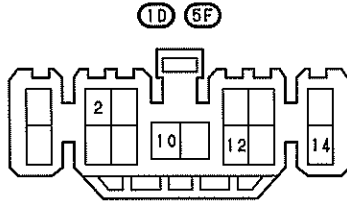
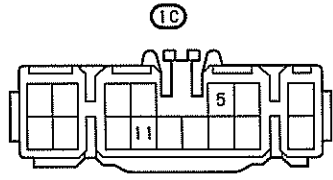
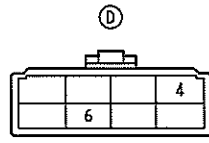
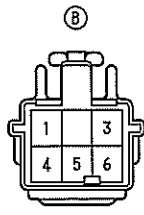
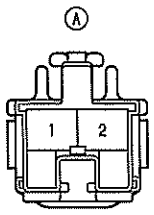

# オートアンテナ

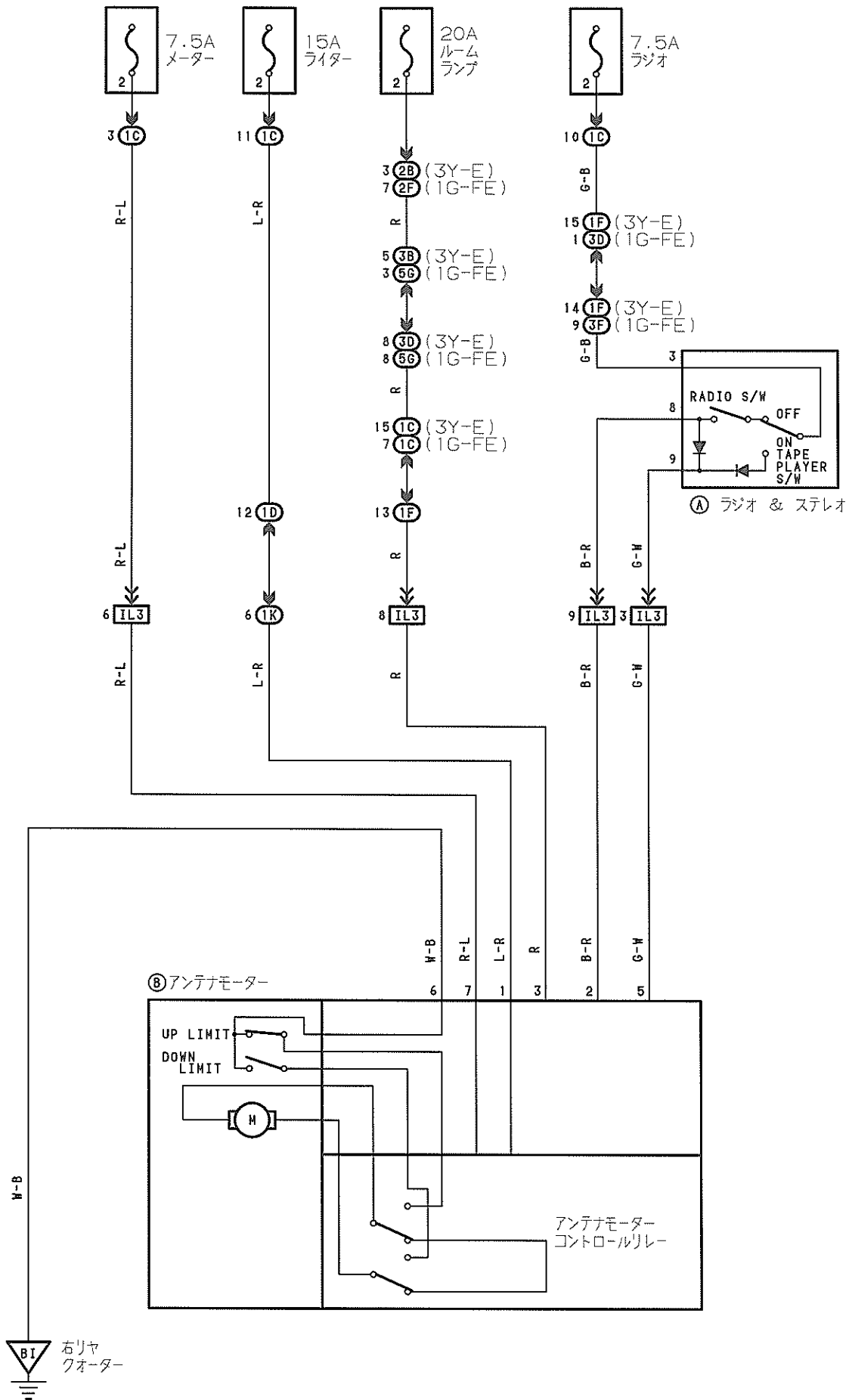

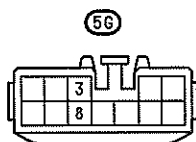
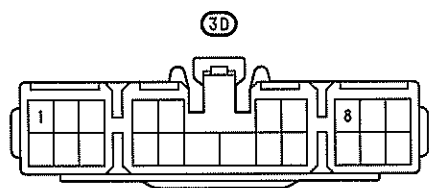
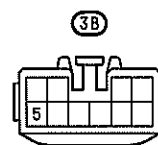
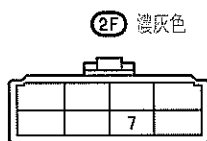
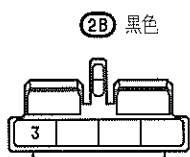
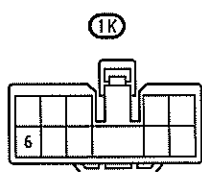
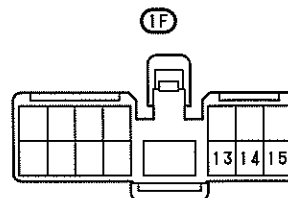
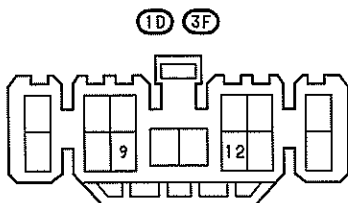
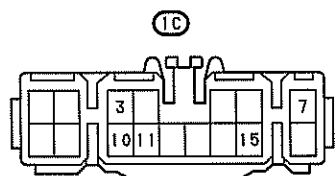
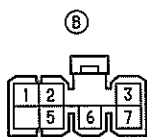
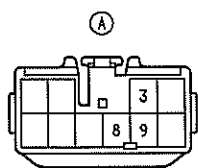

(IL3) 濃灰色

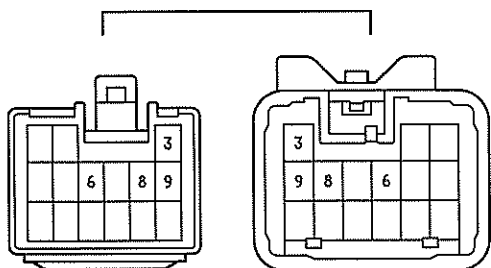



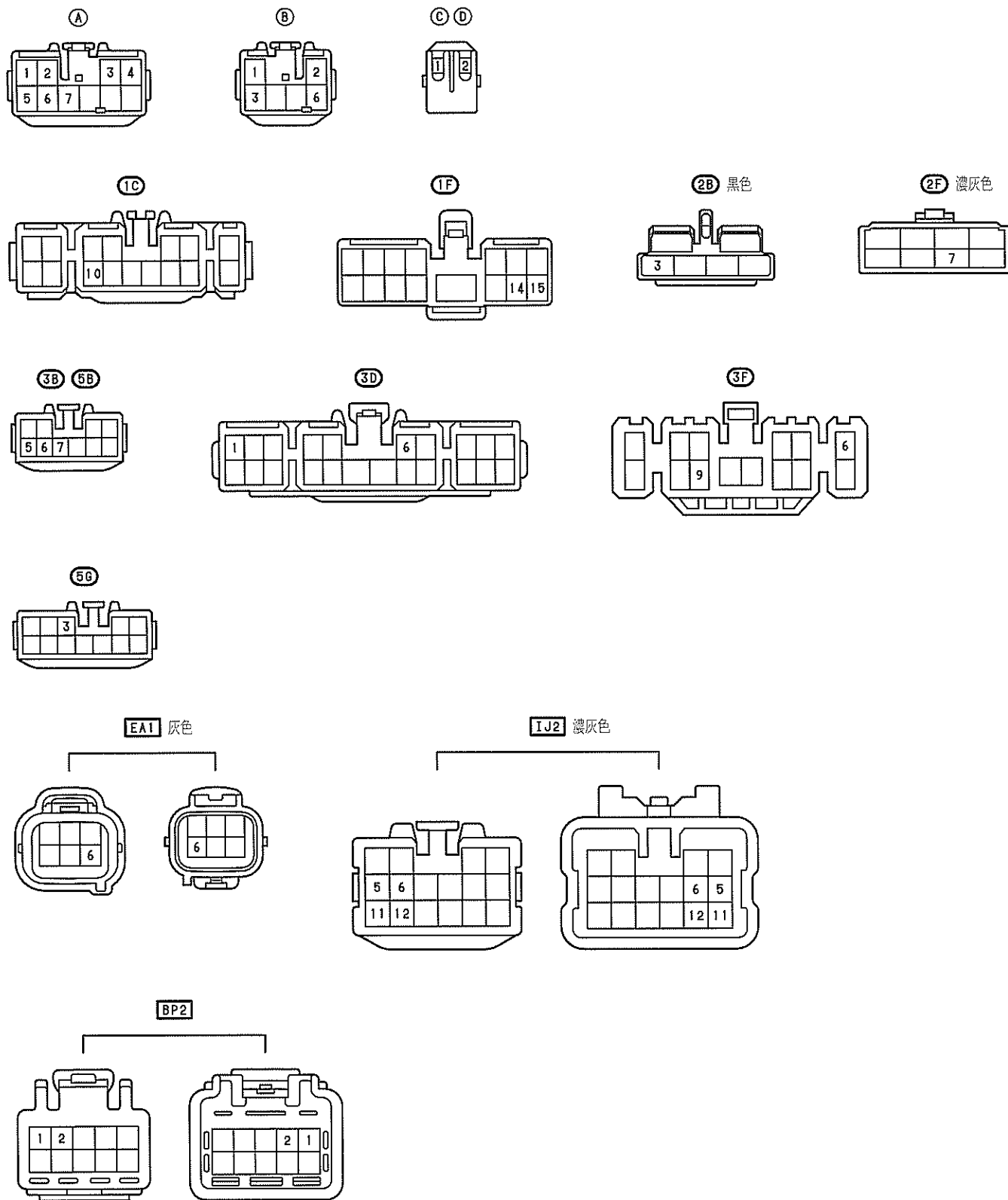

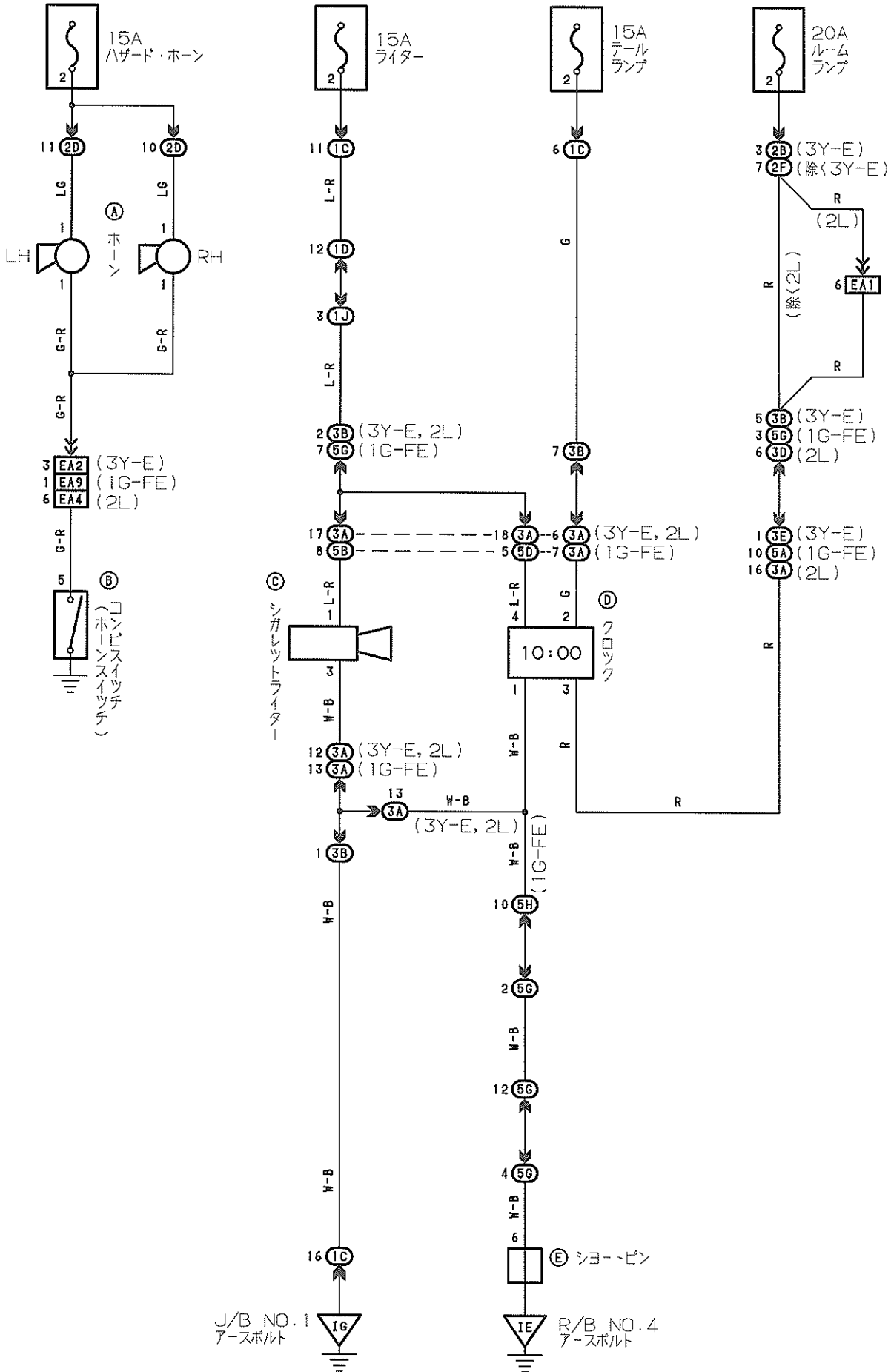

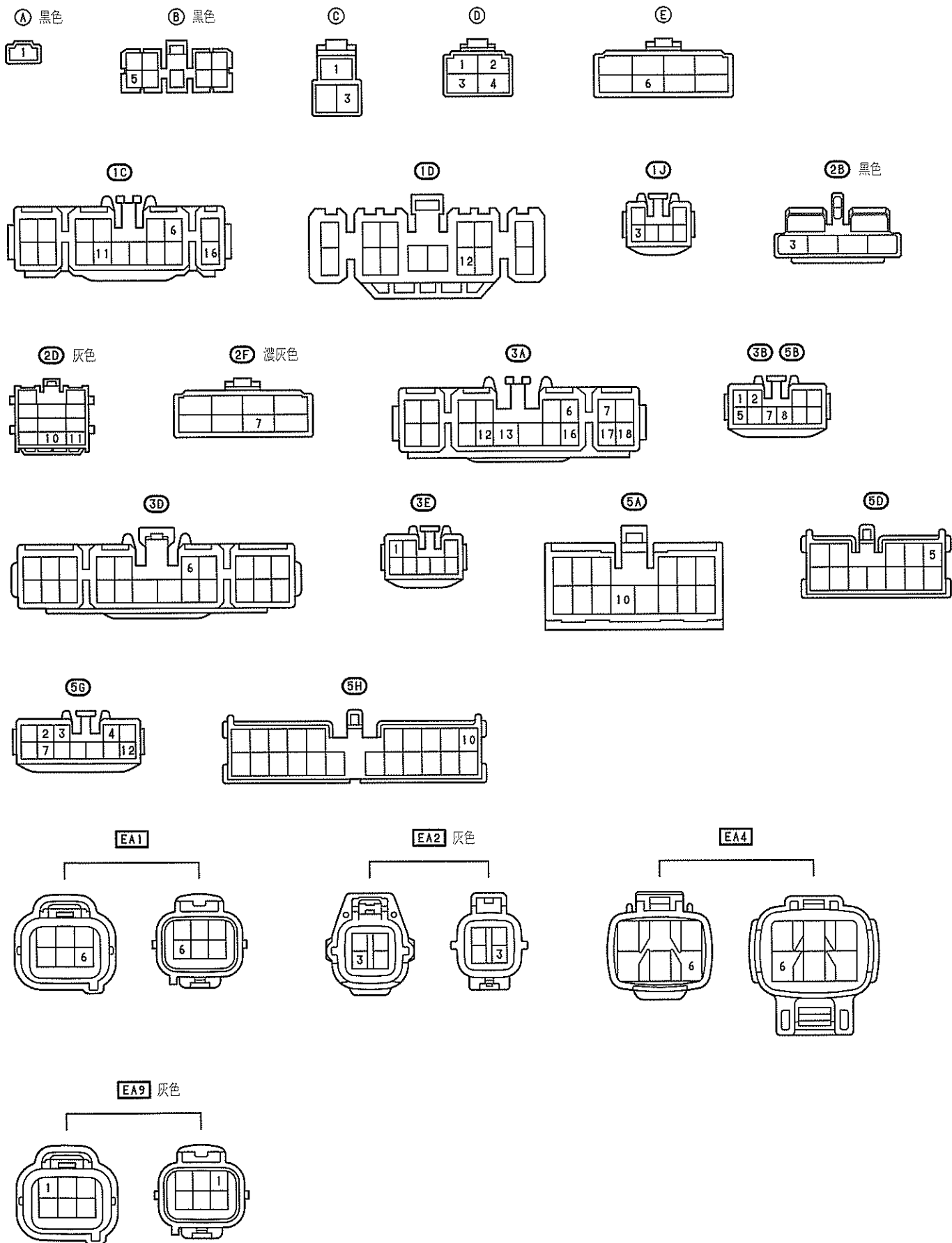



① 灰色

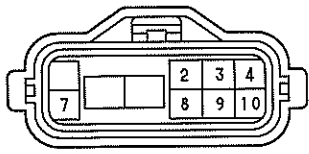

②

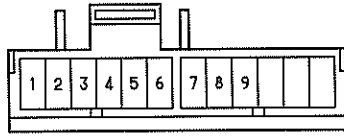

③ 青色



④

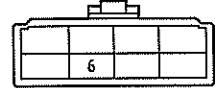

①C

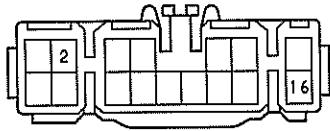

①E

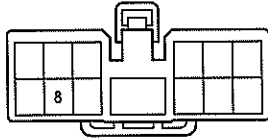

③B ⑤B

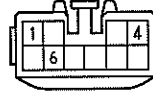

③C ⑤C

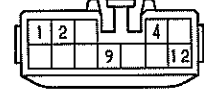

③D

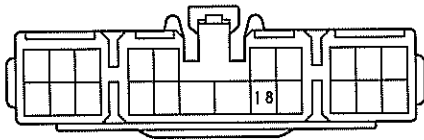

③F ⑤F

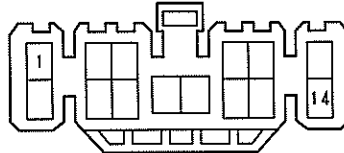

⑥C

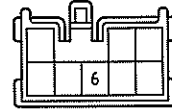

⑤H

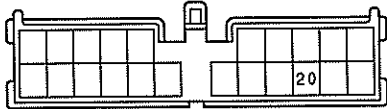

ED6 灰色

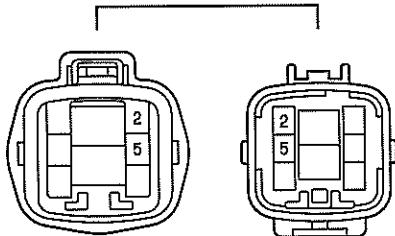

IH3 濃灰色

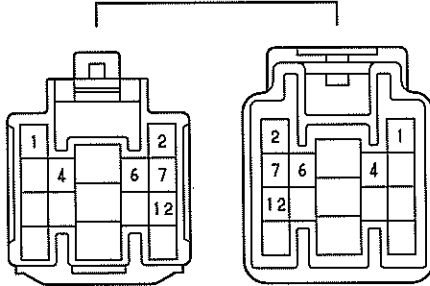

IH4 濃灰色

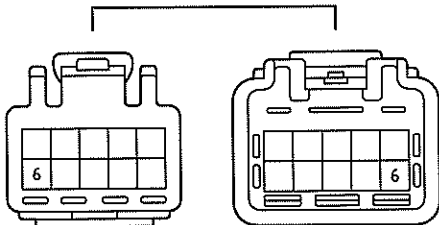

- \*1: 除く1G-FE
- \*2: 1G-FE
- \*3: 3Y-E
- \*4: 2L

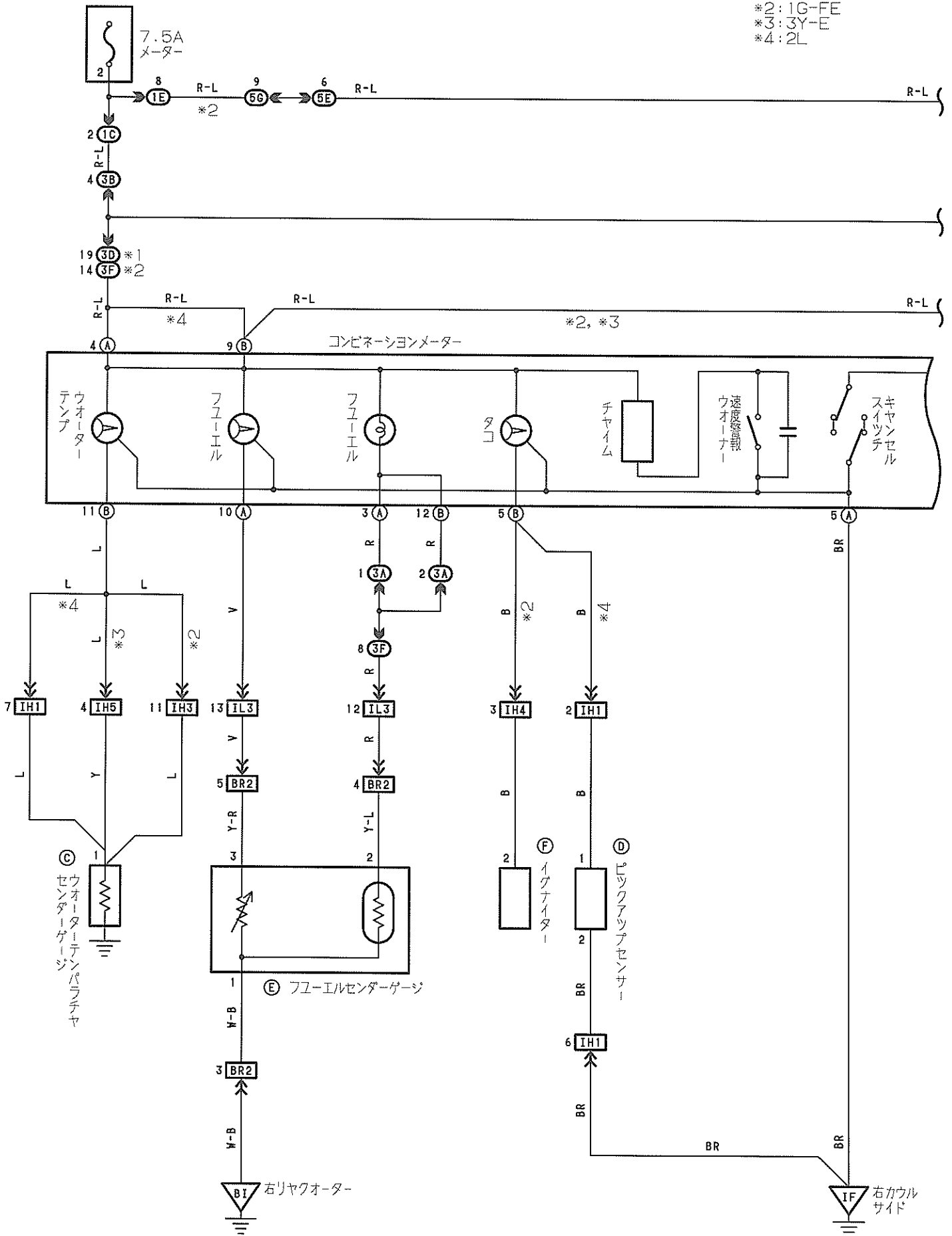





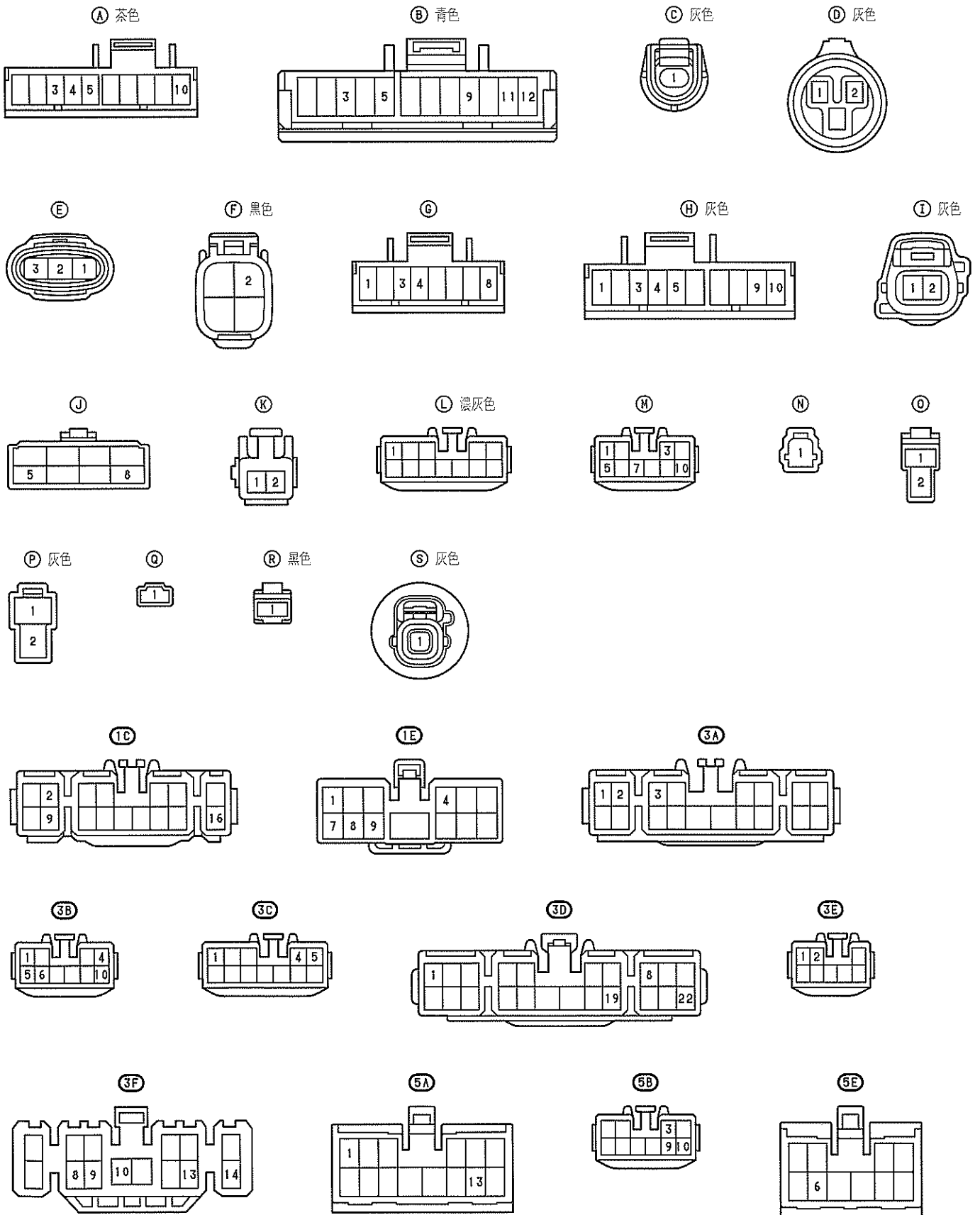

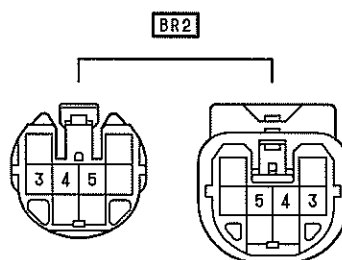
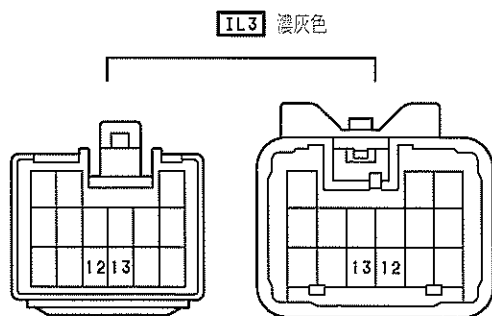
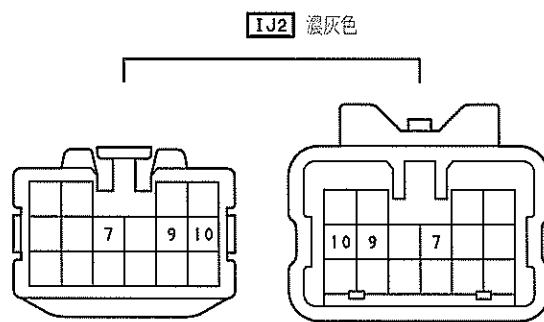
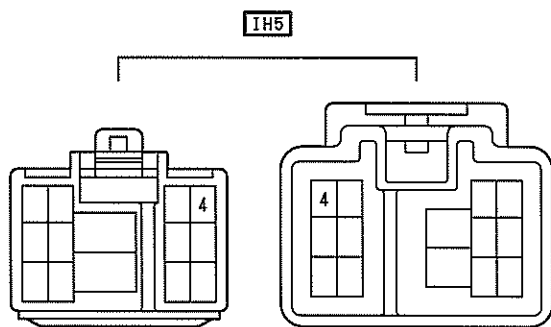
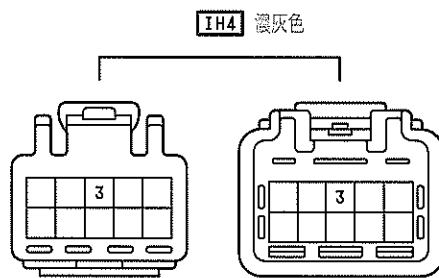
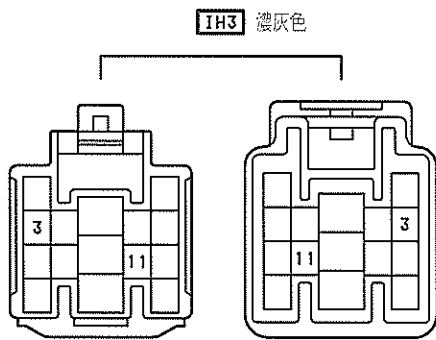
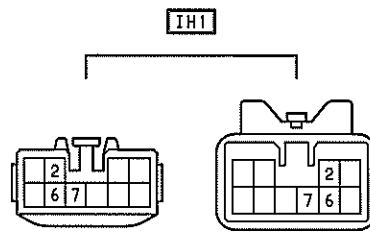
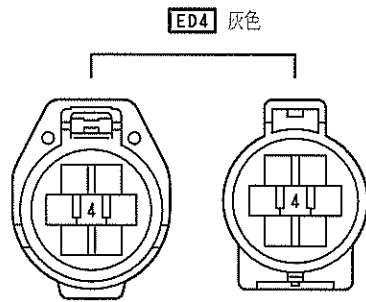
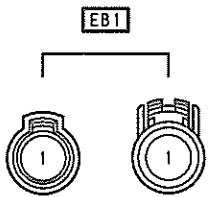
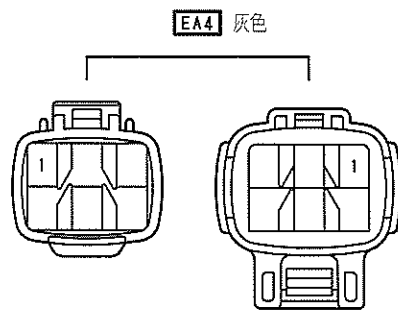
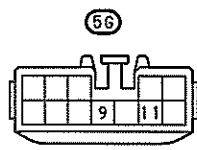
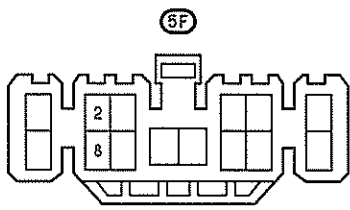



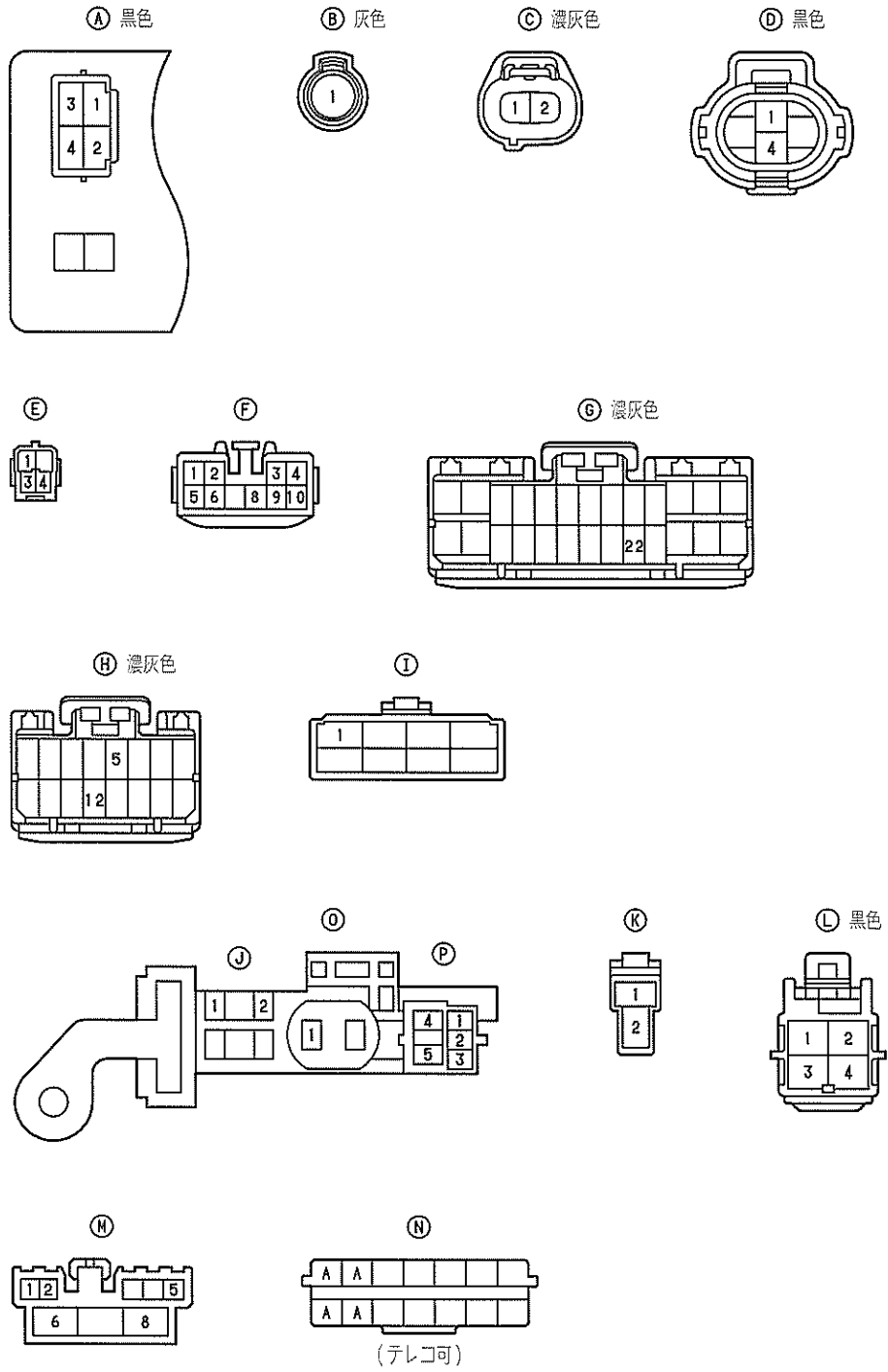
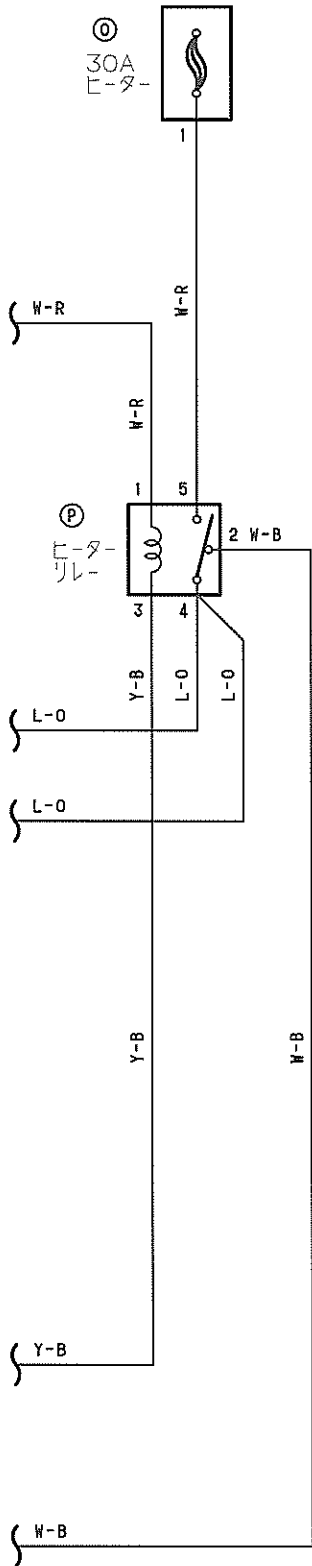

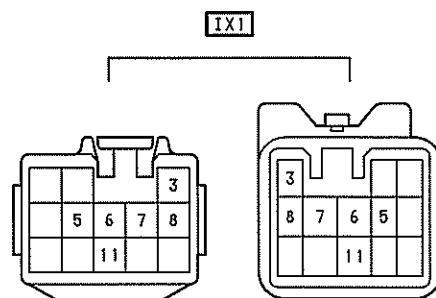
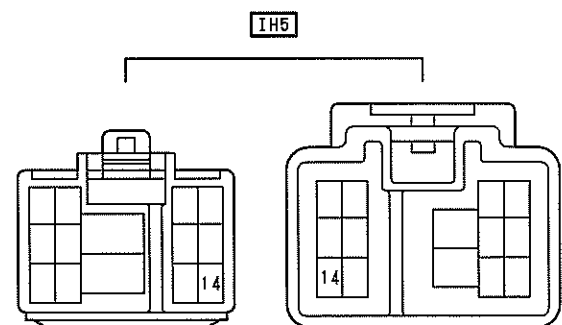
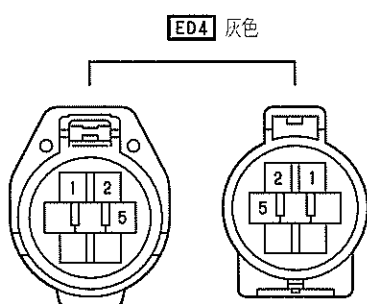
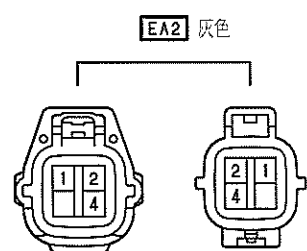
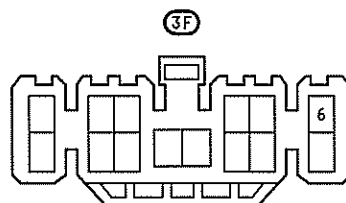
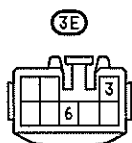
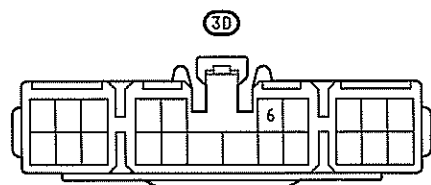
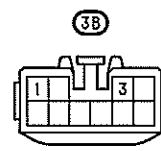
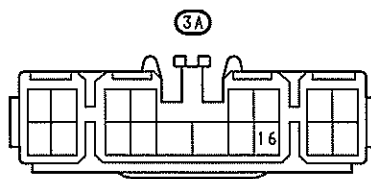
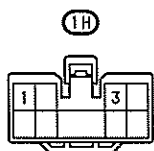
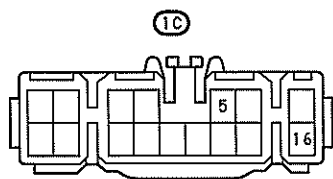

# エアコンディショナー (2L)

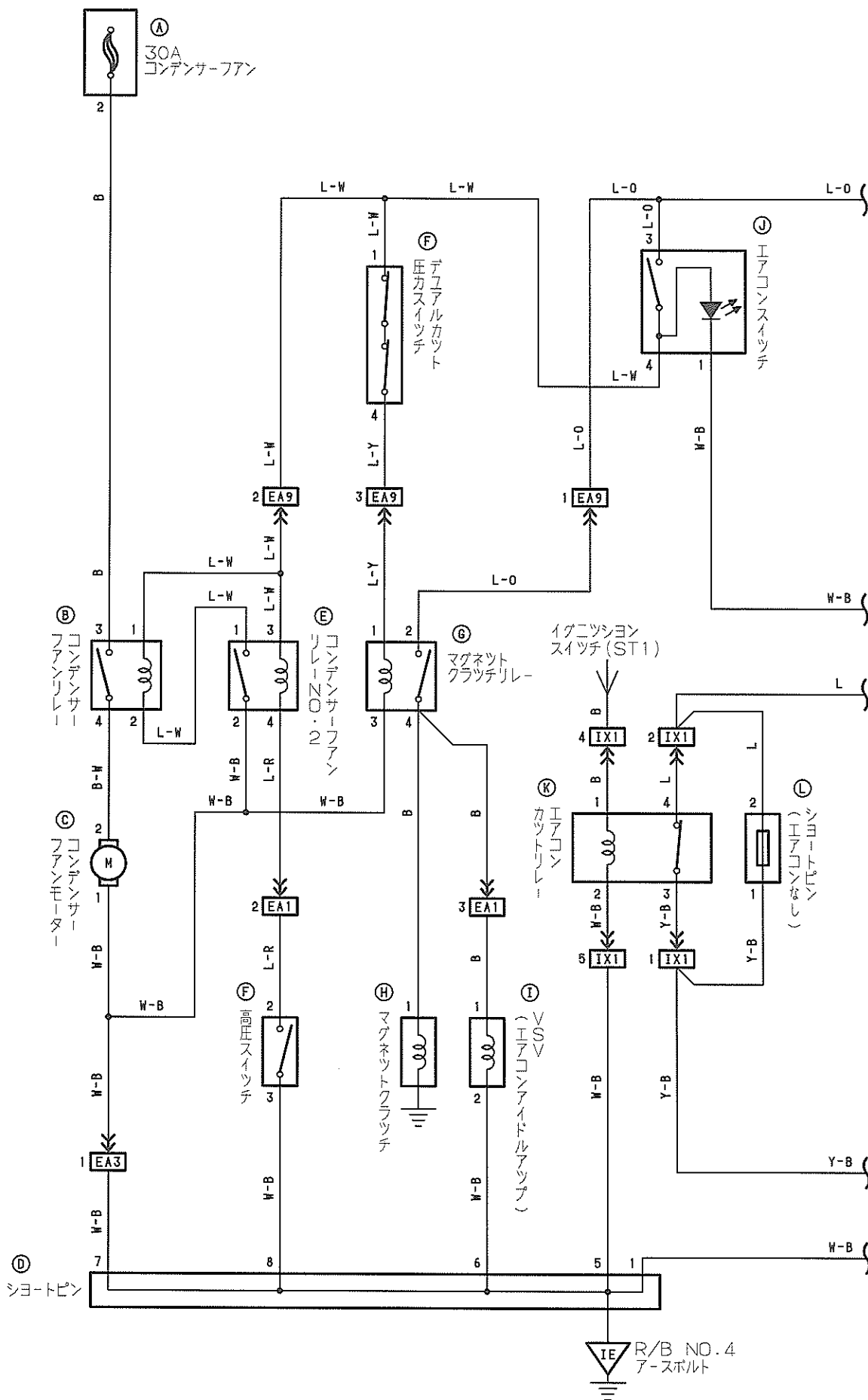

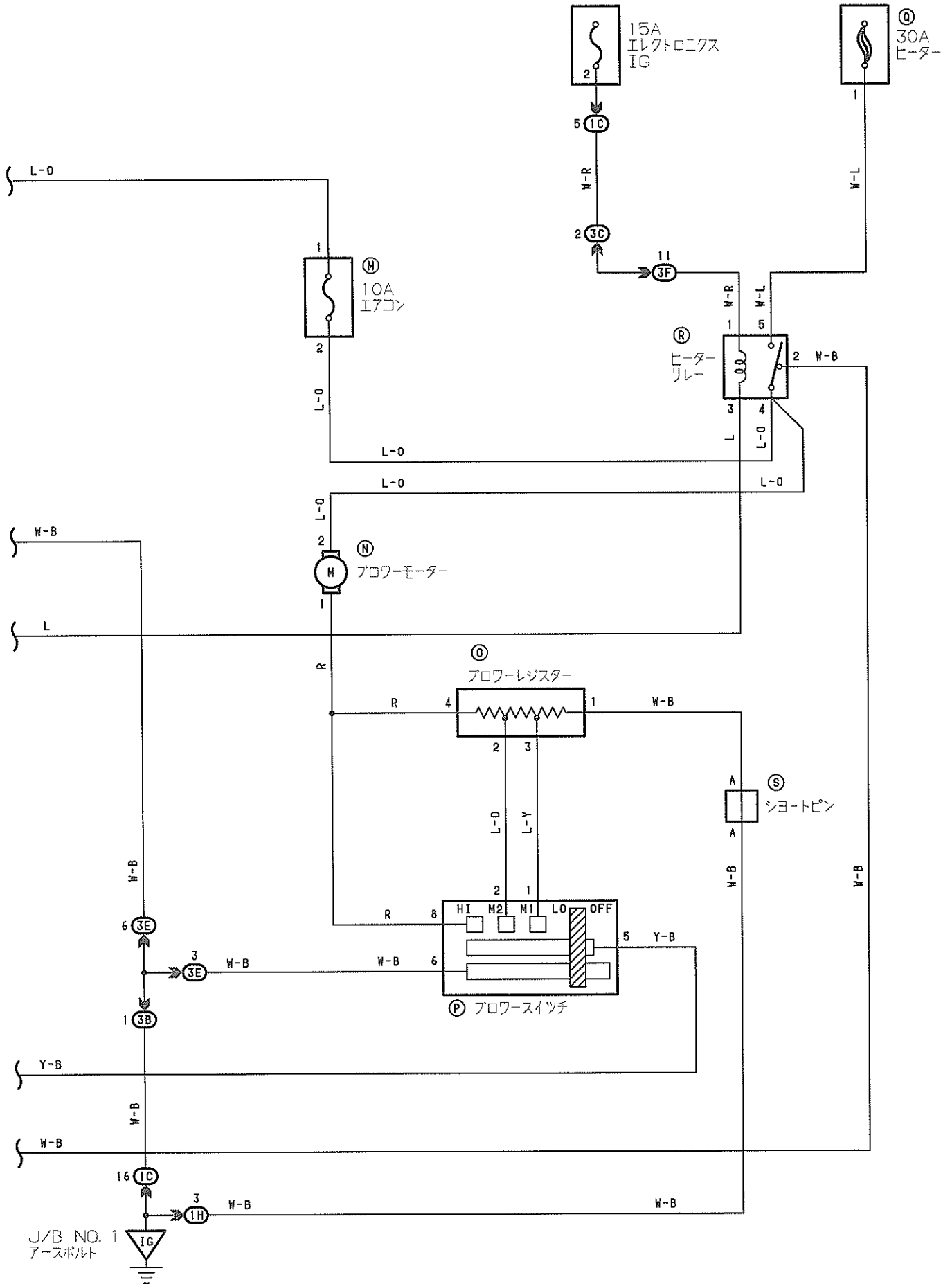



EA1 灰色

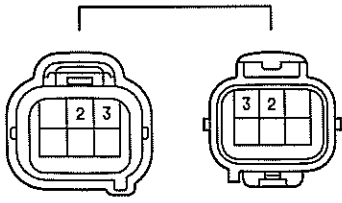

EA3 灰色

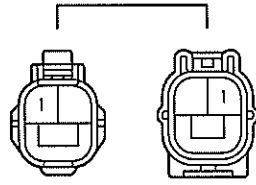

EA9 灰色

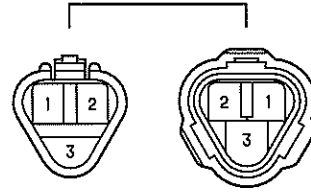

IX1

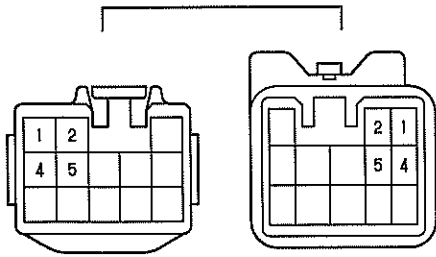

# オートエアコンデショナー

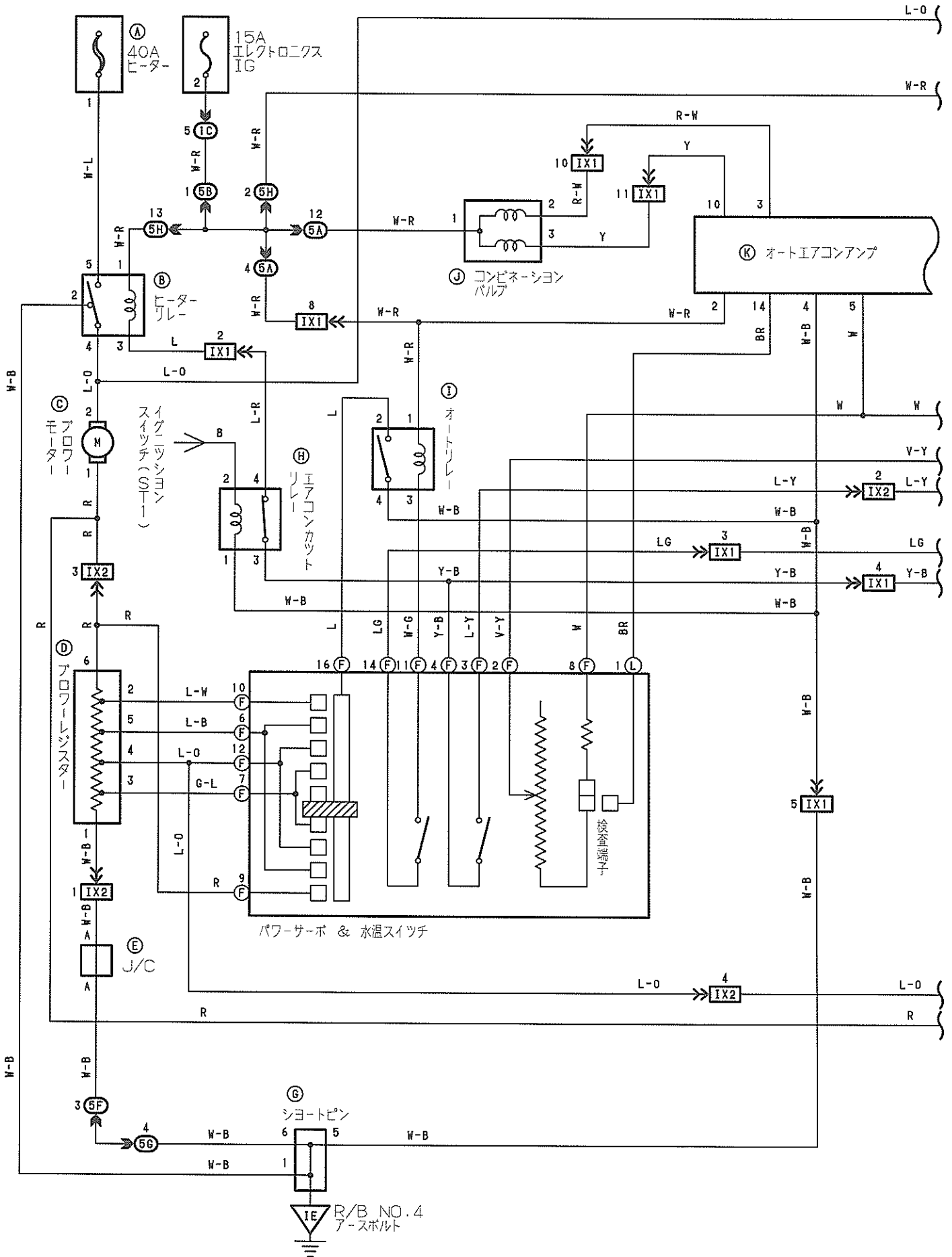

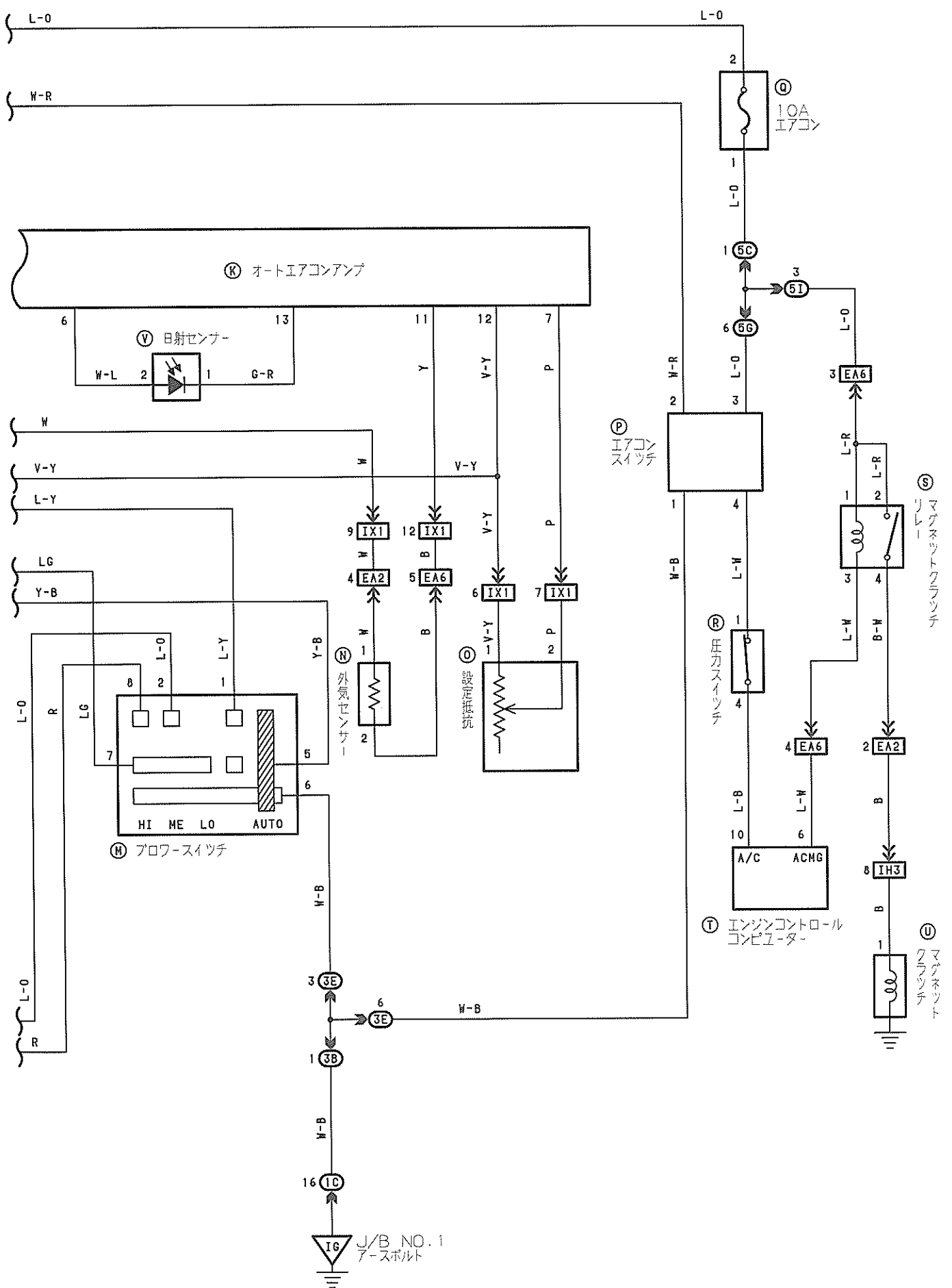

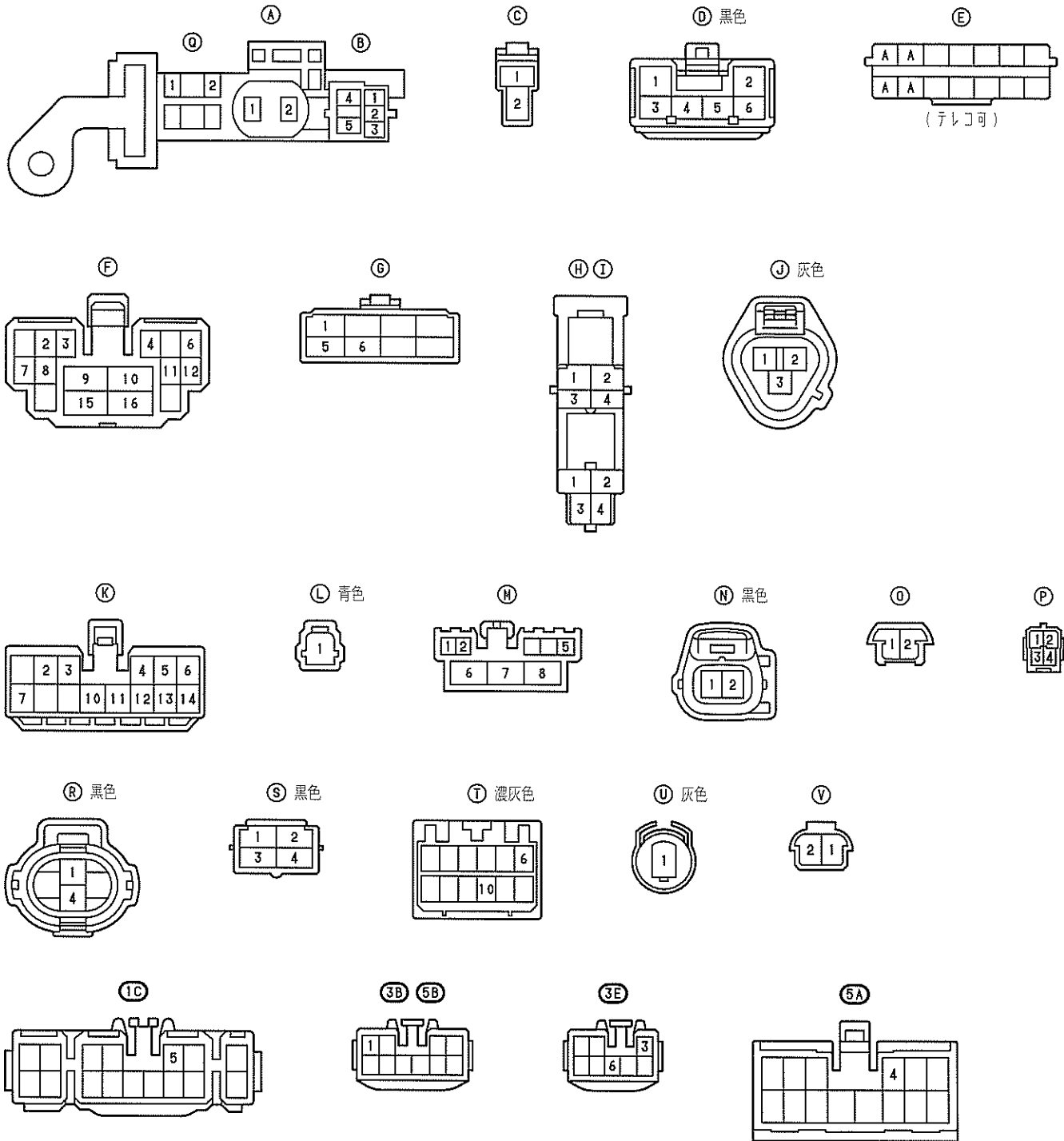

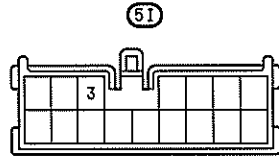
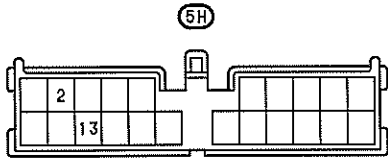
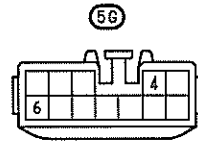
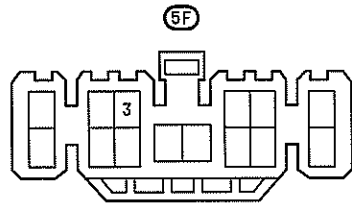
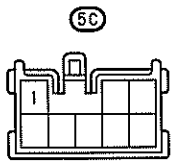

EA2 灰色

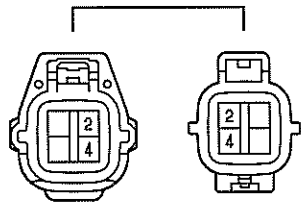

EA6 灰色

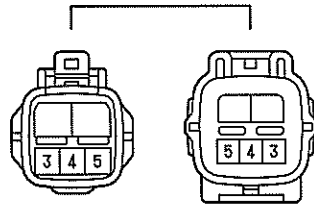

IH3 濃灰色

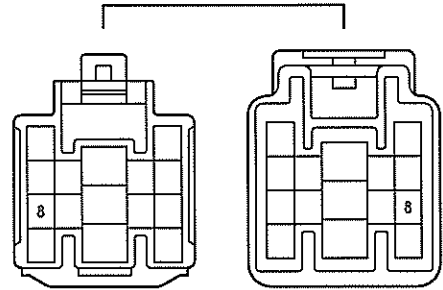

IX1

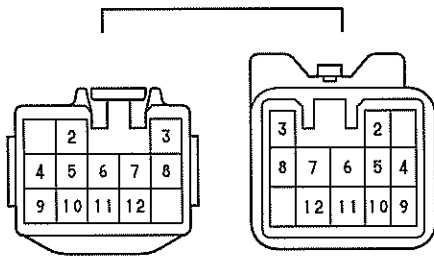

IX2 黒色

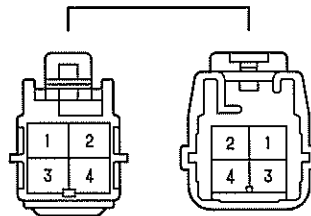

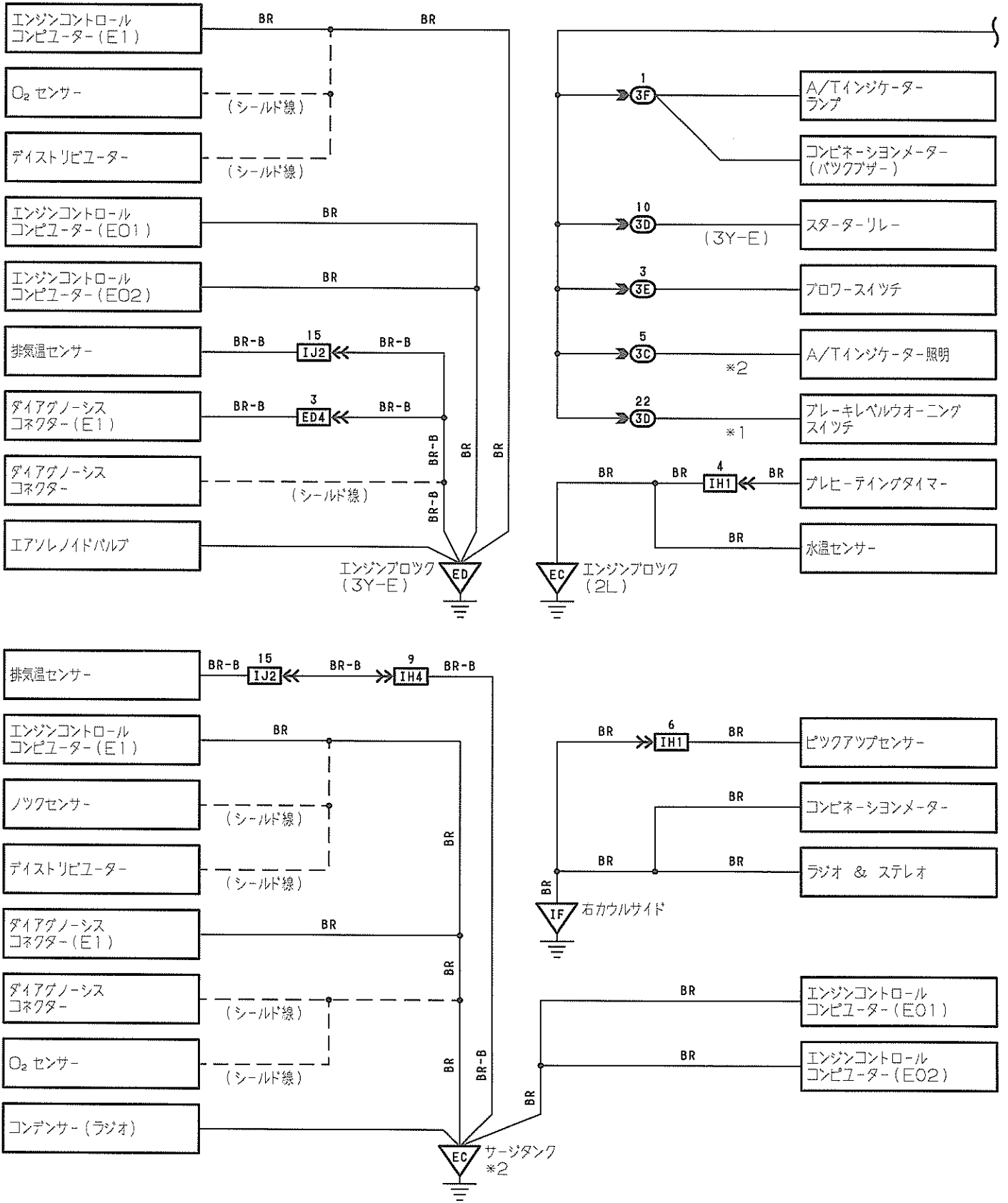

\*1: 3Y-E, 2L  
 \*2: 1G-FE

# アースポイント

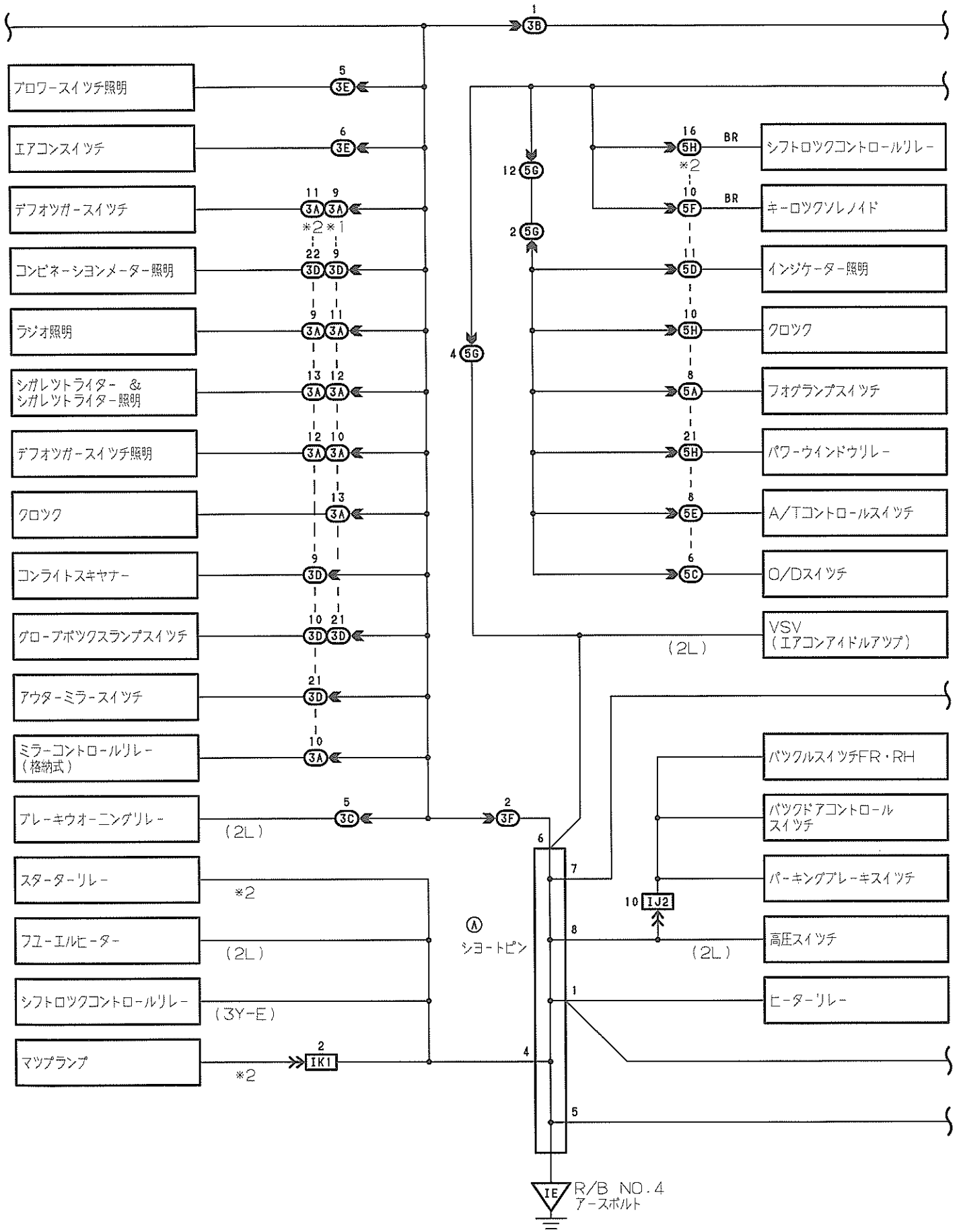



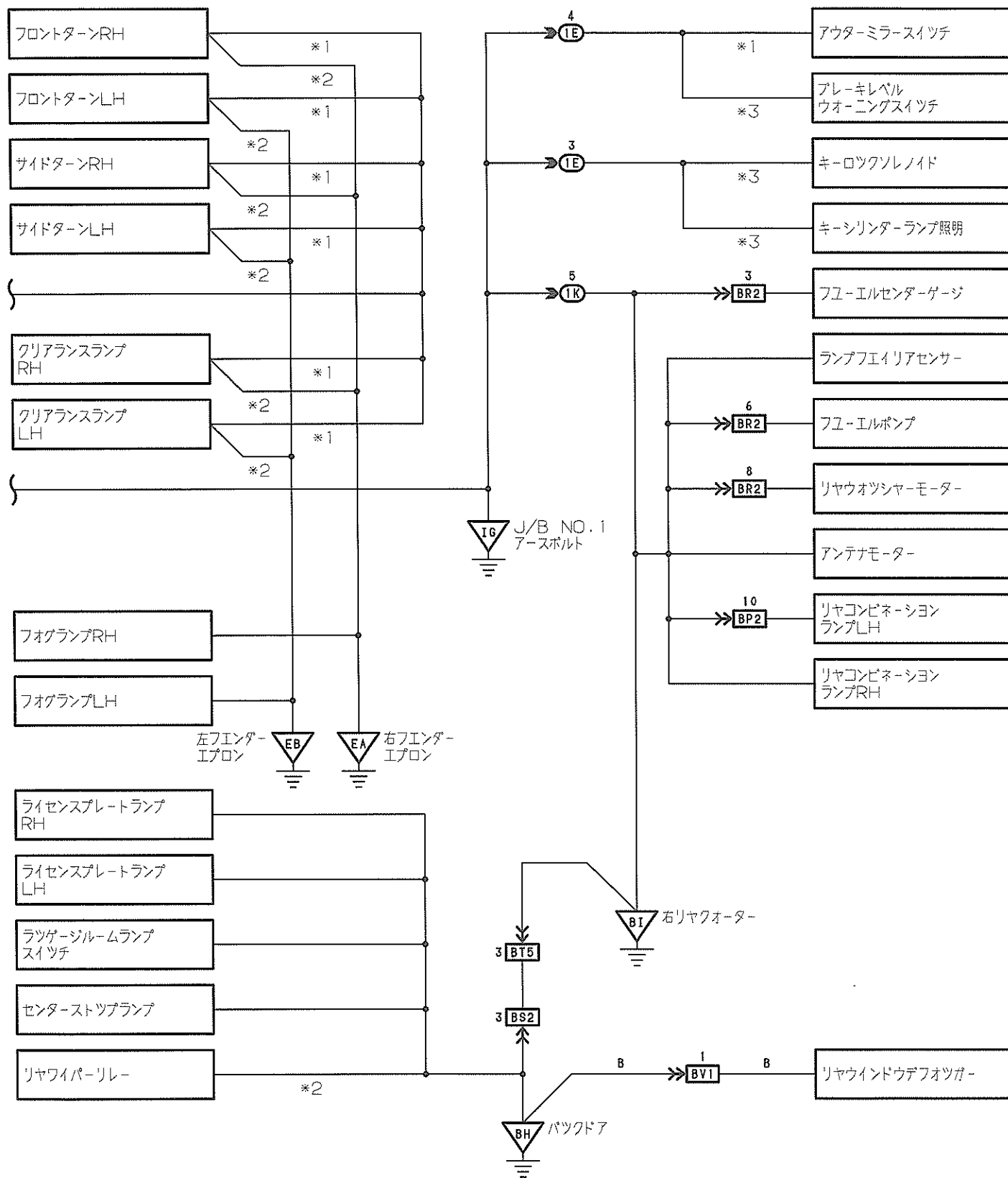

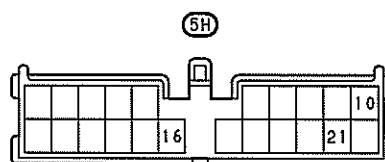
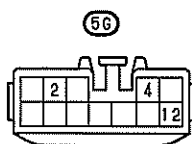
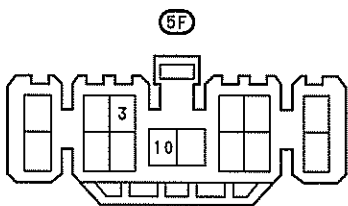
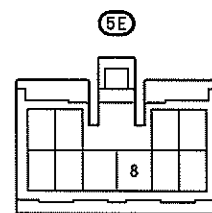
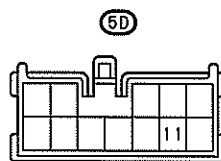
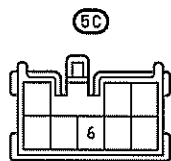
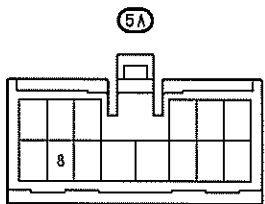
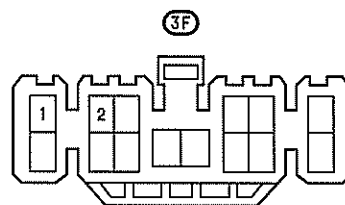
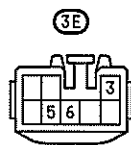
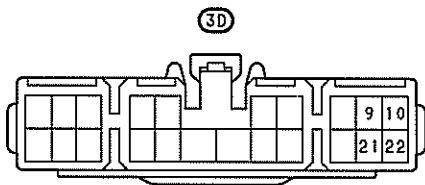
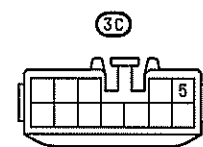
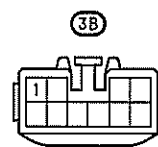
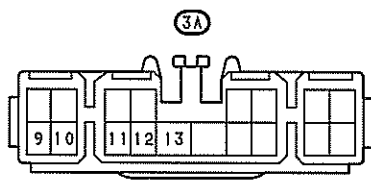
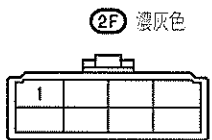
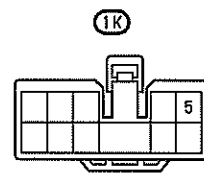
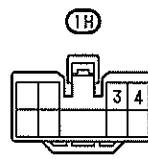
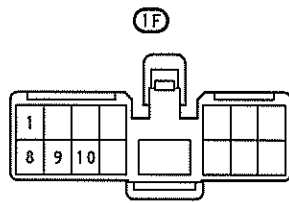
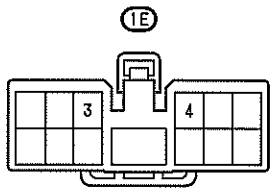
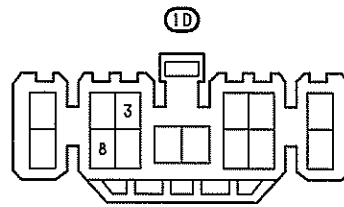
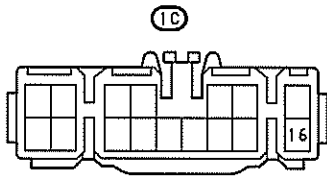
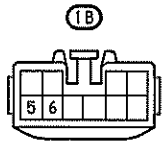
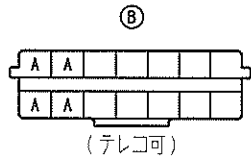
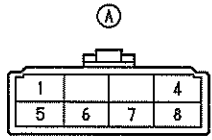

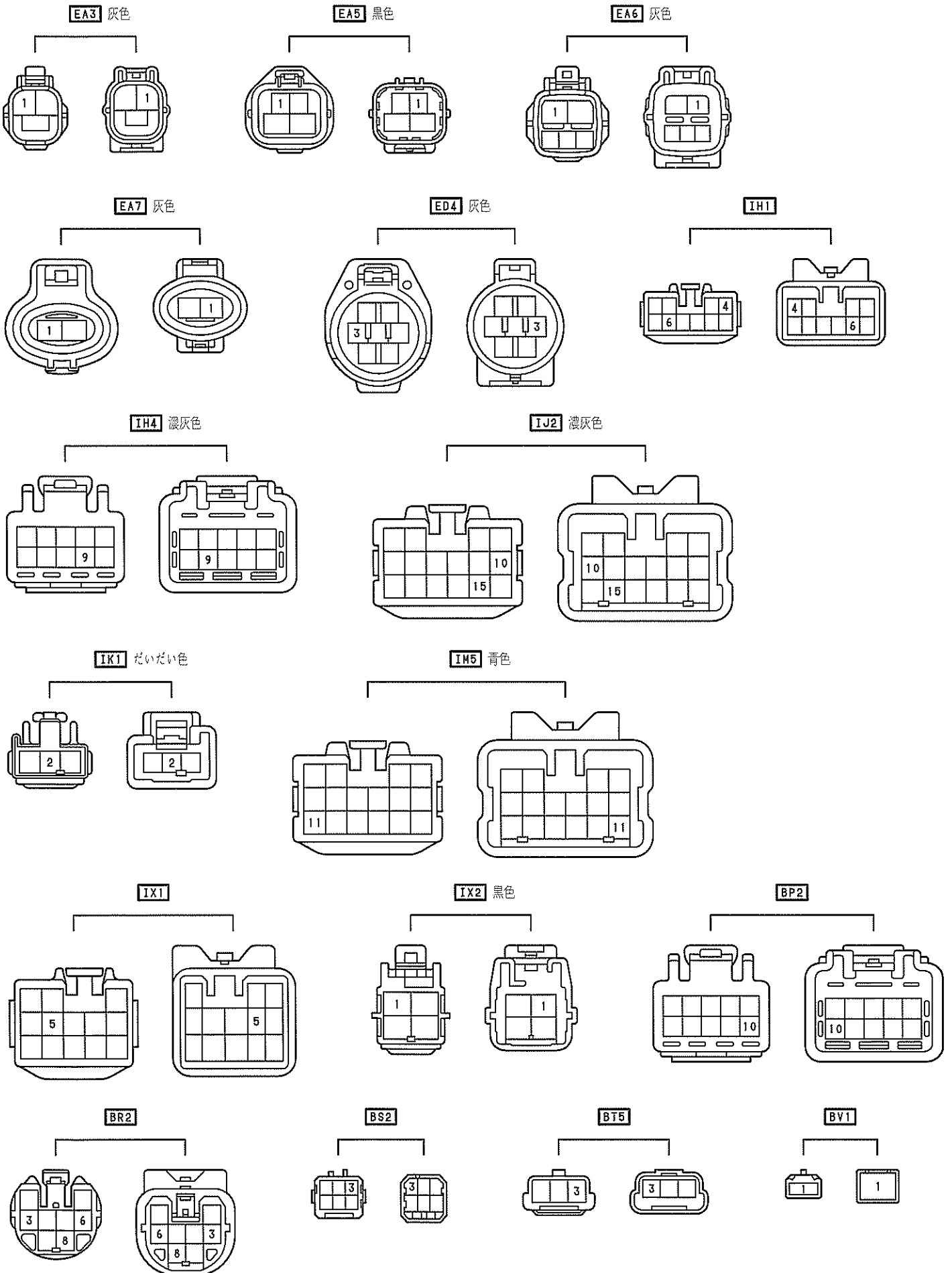

---

MEMO