

2 システム別配線図

電源回路

ヒューズ-負荷	2-2
電源回路	2-6

システム回路

エンジン関係

スターティング & イグニッション(バン)	2-8
スターティング & イグニッション(ワゴン)	2-10
充電(2L)	2-12
充電(2Y-J)	2-14
充電(1G-FE)	2-16
EFI	2-18
グロー	2-23
排出ガス浄化装置	2-25
フューエルヒーター	2-27

シャシ関係

オーバードライブ	2-66
シフトロックシステム	2-68

ボデー関係

フロントワイパー & ウォッシャー	2-50
リヤワイパー & ウォッシャー	2-52
リヤウインドウデフォッガー	2-54
パワーウインドウ	2-56
電動ミラー	2-60
ドアロック	2-63

インストルメントパネル廻り

キーリマインダー	2-55
トランスミッションインジケータ	2-70
ラジオ & ステレオ	2-72
コンビネーションメーター	2-76
シガレットライター & クロック, ホーン	2-81

灯火類

ヘッドランプ	2-28
コンライト(グランデエディション)	2-30
テールランプ	2-32
イルミネーション	2-34
インテリアランプ(バン)	2-36
インテリアランプ(ワゴン)	2-38
フォグランプ(1G-FE)	2-42
ストップランプ	2-43
バックアップランプ	2-44
リヤライトウォーニング(1G-FE)	2-46
ターンシグナル & ハザード	2-48

空調関係

マニュアルエアコンディショナー(2L, 2Y-J)	2-83
オートエアコンディショナー(レバー式)	2-87

その他

アンテナモーター	2-74
アースポイント	
アースポイント	2-91

2

J/B NO.1(右カウルサイド)

電 源		負 荷	ページ
15A	ストップランプ	エンジンコントロールコンピューター	2-20
		コンデンサー(ラジオ), リヤコンビランプ(ストップランプ), ランプフェイリアセンサー, センターストップランプ	2-43
		ランプフェイリアセンサー	2-40
		シフトロックコントロールリレー	2-68
15A	エレクトロニクスIG	オルタネーター(ICレギュレーター付き)	2-12
		ボルテージレギュレーター	2-14
		オルタネーター(ICレギュレーター付き)	2-16
		コンライトスキャナー	2-30
		シフトロックコントロールリレー	2-68
		ヒーターリレー	2-84
20A	ワイパー	ワイパーモーター, ウィンドウシールドワイパーリレー, ウォッシャーモーター, コンビスイッチ(ワイパー & ウォッシャースイッチ)	2-50
		リヤワイパースイッチ & ウォッシャースイッチ, リヤウォッシャーモーター, リヤワイパーモーター, ワイパーリレー(1G-FE)	2-52
15A	テールランプ	アイドルアップダイオード	2-20
		クリアランスランプ, テールランプ, ライセンスプレートランプ	2-32
		ハザードスイッチ照明, ラジオ照明, グローブボックスランプ, シガライター照明, ブロースイッチ照明, デフォッガースイッチ照明, コンビメーター照明, フォグランプ照明, トランスミッションインジケーター照明, A/Tインジケーターランプ(除く2L)	2-34
		フォグランプリレー	2-42
		ランプフェイリアセンサー	2-46
		クロック	2-81
7.5A	ターン	ターンシグナルフラッシャー	2-48
15A	ライター	シフトロックコントロールリレー	2-68
		アンテナモーター	2-74
		シガレットライター, クロック	2-81
7.5A	イグニッション	チャージウォーニングランプ	2-12
		チャージウォーニングランプ	2-14
		チャージウォーニングランプ	2-16
		エンジンコントロールコンピューター	2-18
		プレヒーティングタイマー	2-23
		エミッションコントロールコンピューター, セカンダリスローカットソレノイド, フューエルカットソレノイド(2L), スローカットソレノイド, OVCV	2-25
		フューエルヒーターリレー	2-27
		インジケーターランプ	2-77
7.5A	ラジオ	アウターミラースイッチ	2-60
		ラジオ & ステレオ	2-72
		アンテナモーター	2-74

J/B NO.1(右カウルサイド)

電 源	負 荷	ページ	
7.5A	メーター	コンビメーター(グローインジケータランプ)	2-23
		排気温ランプ	2-25
		コンビメーター(リバースウォーニングランプ), リヤコンビランプ(バックアップランプ)	2-44
		リヤライトウォーニングランプ, ランプフェイリアセンサー	2-46
		デフォッガースイッチ, デフォッガーリレー	2-54
		キーリマインダー	2-55
		メインリレー(パワー), パワーウインドウリレー	2-56
		コンビメーター(O/D OFFインジケータランプ), O/Dリレー, O/Dソレノイド	2-66
		コンビメーター(トランスミッションインジケータ)	2-70
		アンテナモーター	2-74
	コンビネーションメーター, インジケータランプ	2-76	
15A	フォグランプ	フォグランプ	2-42
30A	C/B デフォッガー	ノイズフィルター, リヤウインドウデフォッガー	2-54

J/B NO.2(エンジンルーム)

15A	EFI	エンジンコントロールコンピューター, サーキットオープニングリレー, ISCV, ダイアグノーシスコネクター, フューエルポンプ	2-18
15A	ハザードホーン	ターンシグナルフラッシャー, コンビメーター(ターンシグナルスイッチ), ハザードスイッチ	2-48
		ホーン	2-81
20A	ルームランプ	コンライトスキャナー	2-30
		デッキルームランプ, ルームランプ, 半ドアインジケータランプ	2-36
		マップランプ, ルームランプ, 半ドアインジケータランプ, ドアカーテシランプ, ルームランプコントロールリレー	2-38
		キーリマインダー	2-55
		ミラーコントロールリレー	2-61
		ラジオ & ステレオ	2-72
		アンテナモーター	2-74
	クロック	2-81	
7.5A	チャージ	ボルテージレギュレーター	2-14
15A	ヘッドランプ(左)	ヘッドランプLH	2-28
15A	ヘッドランプ(右)	ヘッドランプRH	2-28
40A	FL AM1	イグニッションスイッチ(AM1), C/Bドアロック, C/Bパワー	2-6
		スターターリレー, スターター	2-8
		スターター	2-10
		オルタネーター(ICレギュレーター付き)	2-12, 2-16
		ボルテージレギュレーター	2-14
		プレヒーティングタイマー	2-23
		フューエルヒーター	2-27

J/B NO.2(エンジンルーム)

電 源		負 荷	ページ
30A	FL AM2	イグニッションスイッチ(AM2), ヒューズEFI	2-6
		IIA(2Y-J)	2-8
		コンデンサー(ラジオ), イグニッションコイル & イグナイター	2-10
30A	FLラジエーターファン	コンデンサーファンモーター	2-83
80A 100A (注)	FLオルタ	FL AM1, オルタネーター(ICレギュレーター付き), C/Bヒーター, ヒューズテールランプ, テールランプリレー, C/Bデフォッガー, ヒューズストップランプ, ヒューズフォグランプ, FLコンデンサーファン	2-6
		FL AM1, スターター	2-8
		FL AM1, オルタネーター(ICレギュレーター付き)	2-12
		FL AM1, オルタネーター	2-14
		テールランプリレー, ヒューズテールランプ	2-32, 2-34
80A	FLグロー	グロープラグカレントセンサー, グロープラグレジスター	2-23

(注) 80A : 2Y-J 100A : 2L, 1G-FE)

J/B NO.4(左カウルサイド)

10A	エアコン	マグネットクラッチ, ラジエーターファンリレー, ブロワースイッチ, VSV(アイドルアップ)	2-84
		マグネットクラッチリレー, エンジンコントロールコンピューター	2-88
30A	C/B ヒーター	ブLOWERモーター, ヒューズエアコン	2-84
40A	C/B ヒーター	ブLOWERモーター, ヒューズエアコン	2-88

ヒューズブルリンク(バッテリー横)

2.0L	FL メイン	ヘッドランプリレー, ヒューズヘッドランプ(左), ヒューズヘッドランプ(右), FL AM2, ヒューズルームランプ, ヒューズハザードホーン, FL オルタ, FL グロー	2-6
		ヘッドランプリレー, ヒューズヘッドランプ(左), ヒューズヘッドランプ(右)	2-28

サーキットブレーカー(右カウルサイド)

30A	C/B ドアロック	ドアコントロールリレー	2-63
30A	C/B パワー	パワーウィンドウリレー, ドアコントロールスイッチ, パワーウィンドウ	2-56

MEMO

2

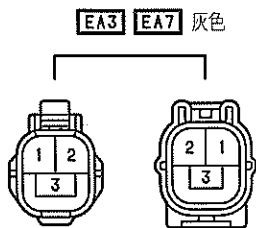
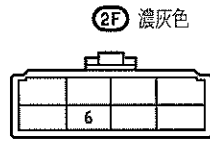
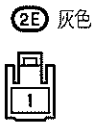
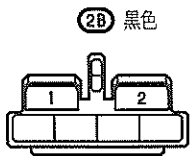
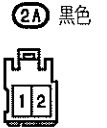
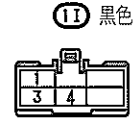
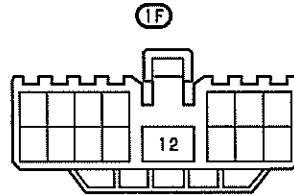
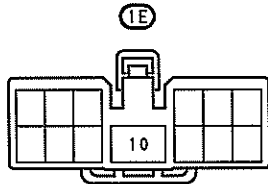
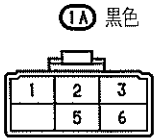
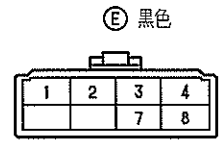
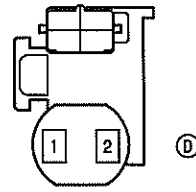
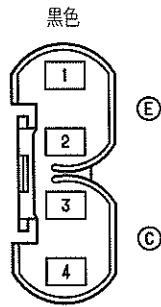
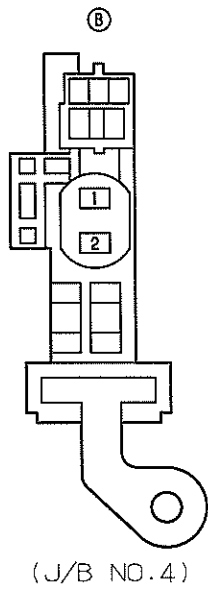
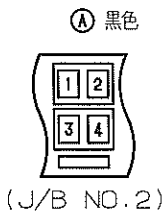

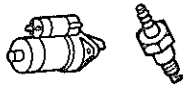

スターティング & イグニッション(バン)

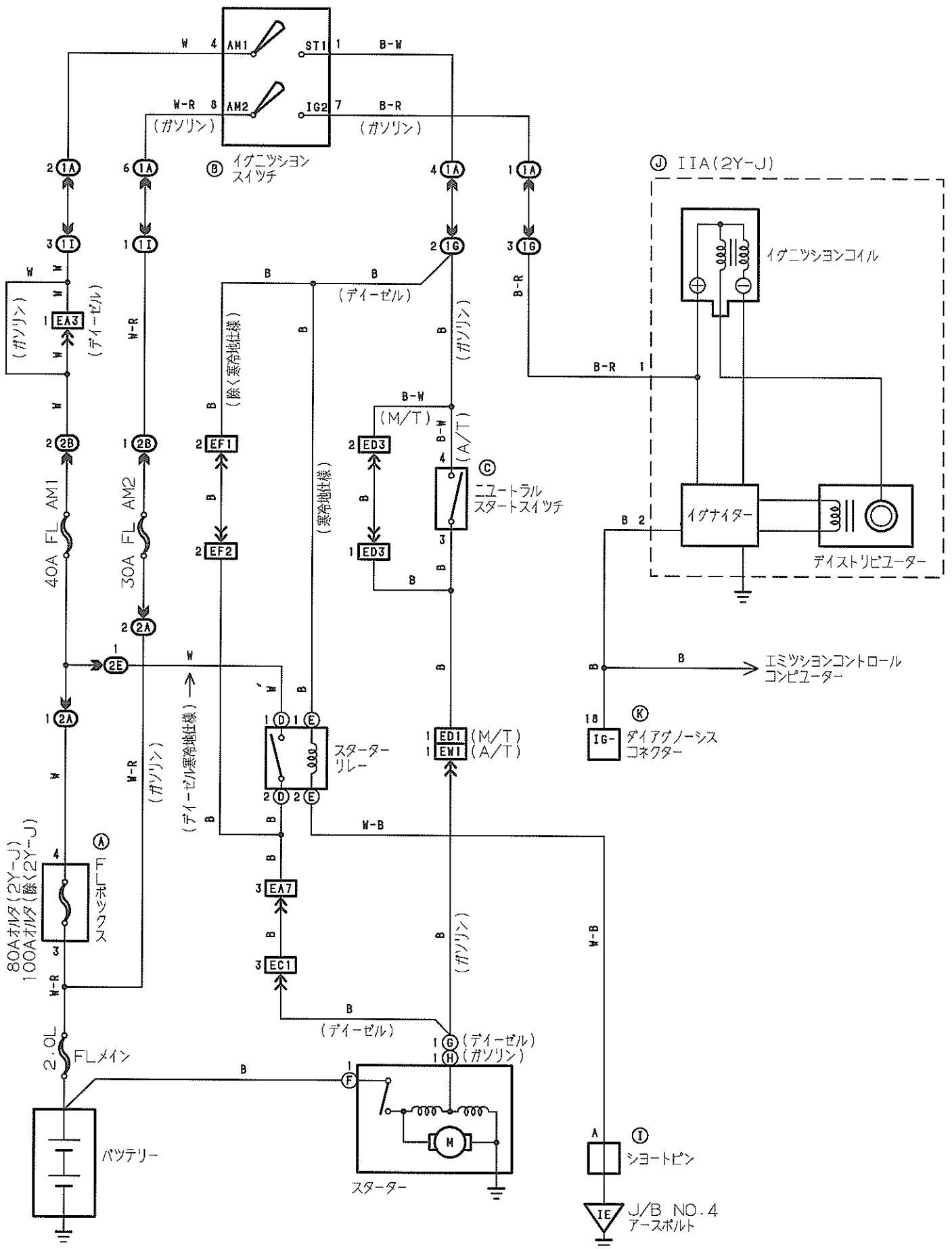

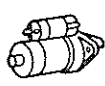

Ⓐ 黒色



(J/B NO.2)

Ⓑ 黒色

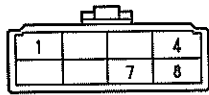

Ⓒ 灰色

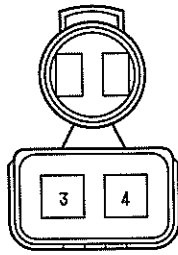

Ⓓ 灰色

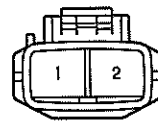

Ⓔ 灰色

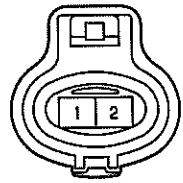

Ⓕ

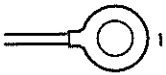

(2Y-J) Ⓖ 黒色



(2L) Ⓗ 黒色



Ⓘ

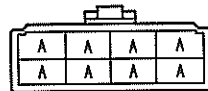

(R/B NO.4)
(テレコ可)

Ⓙ 濃灰色



Ⓚ 黒色

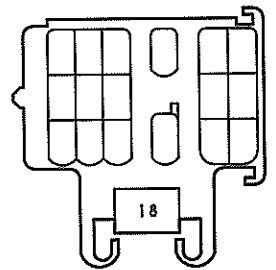

ⓁⒶ 黒色

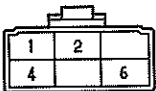

ⓁⒾ 黒色



ⓁⓂ 黒色



ⓁⒶ 黒色



ⓁⒸ 黒色

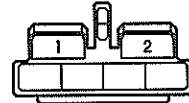

ⓁⒺ 灰色



ⒺⒶ ⒺⒶ 灰色

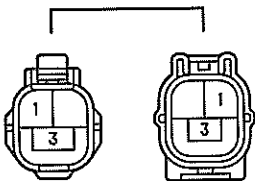

ⒺⒸ 黒色

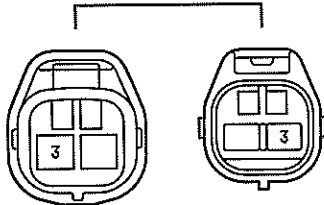

ⒺⒹ ⒺⒹ ⒺⒹ 灰色

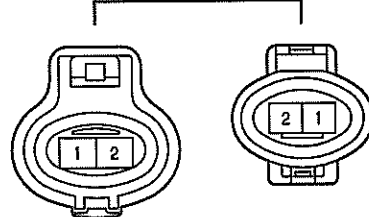

ⒺⒹⒶ 灰色

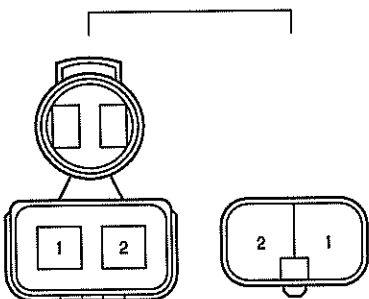

ⒺⒹⒸ 灰色

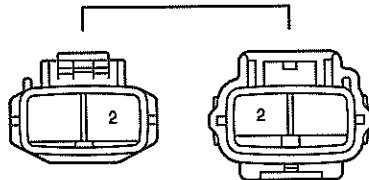



スターティング & イグニツション(ワゴン)

Ⓐ 黒色

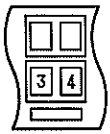

Ⓑ 黒色

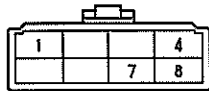

Ⓒ

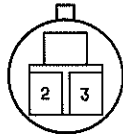

Ⓕ 灰色



Ⓖ



Ⓗ 青色

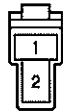

(J/B NO.2)

Ⓘ 灰色

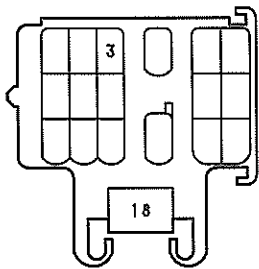

Ⓙ 濃灰色



Ⓚ 黒色

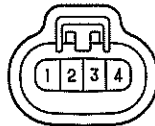

Ⓛ 濃灰色

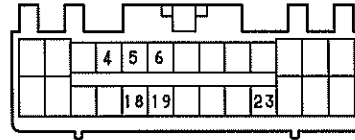

ⓁⒶ 黒色

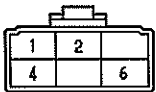

ⓁⒷ 黒色

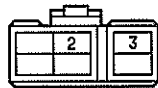

ⓁⒾ 黒色



Ⓛ2Ⓐ 黒色



Ⓛ2Ⓑ 黒色

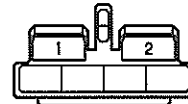

EA3 灰色

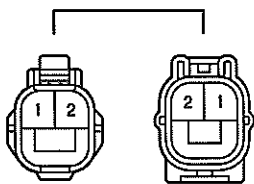

EG2 灰色

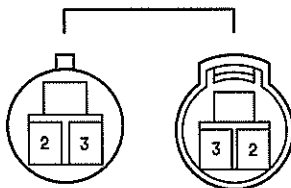

IH3 濃灰色

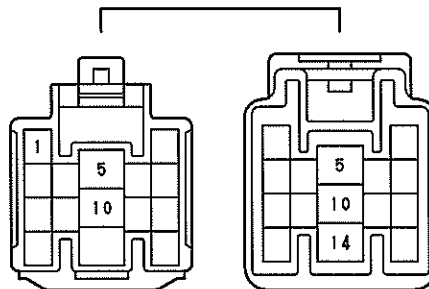

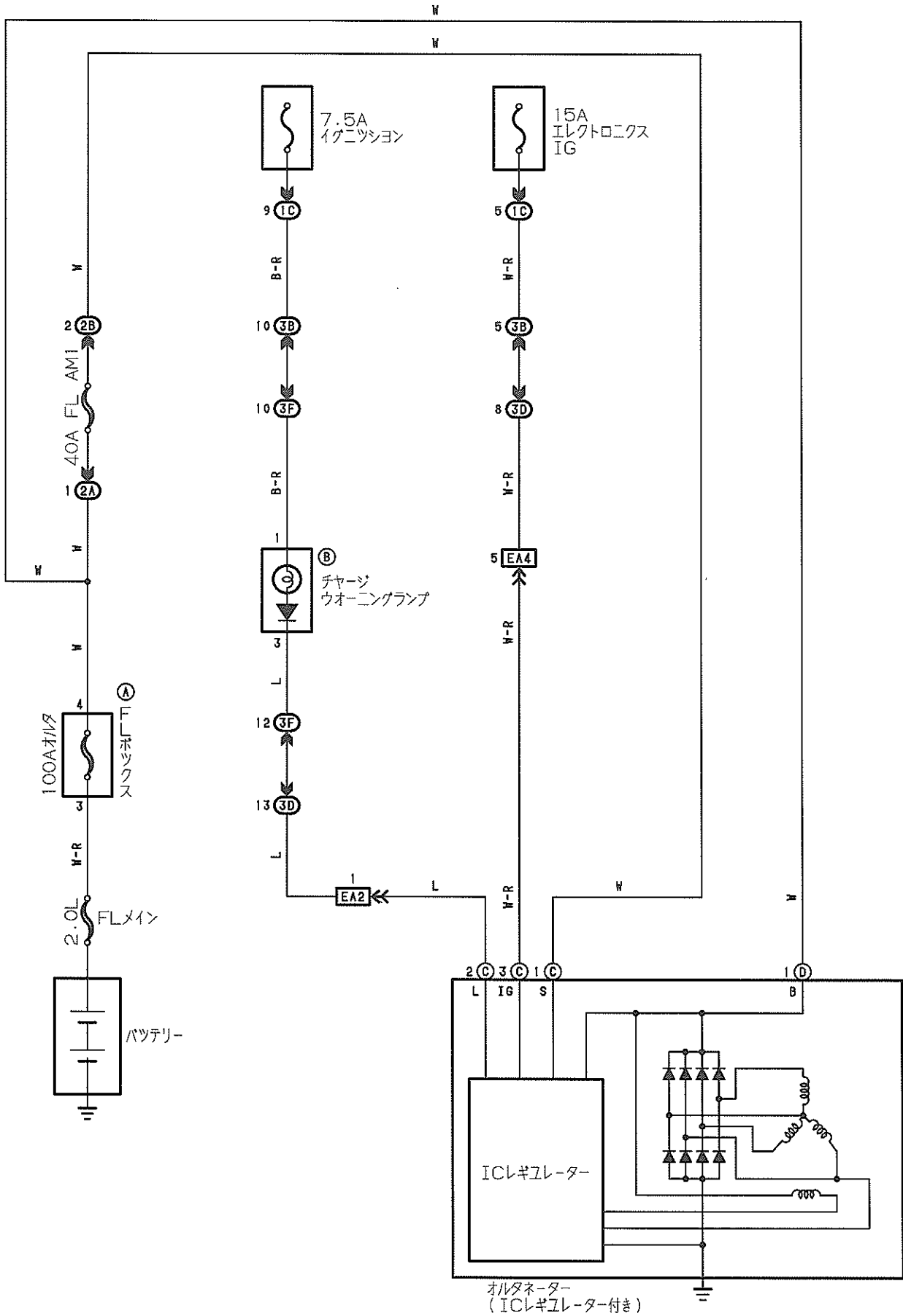

Ⓐ 黑色



(J/B NO.2)

Ⓑ 灰色

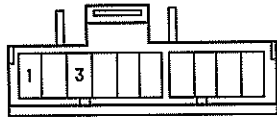

Ⓒ 黑色

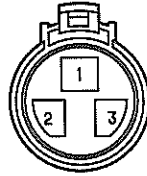

Ⓓ

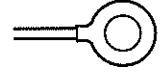

1Ⓒ

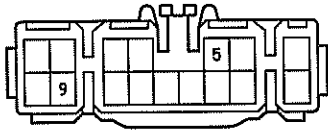

2Ⓐ 黑色



2Ⓑ 黑色

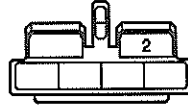

3Ⓑ

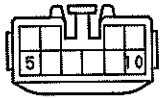

3Ⓓ

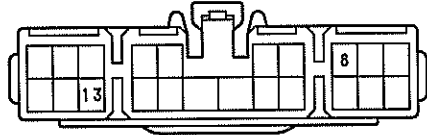

3Ⓕ

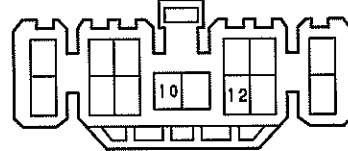

EA2 灰色

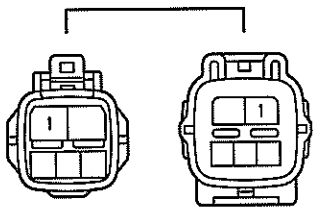

EA4 灰色

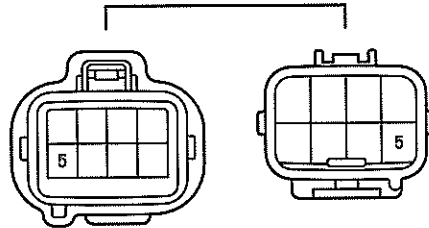

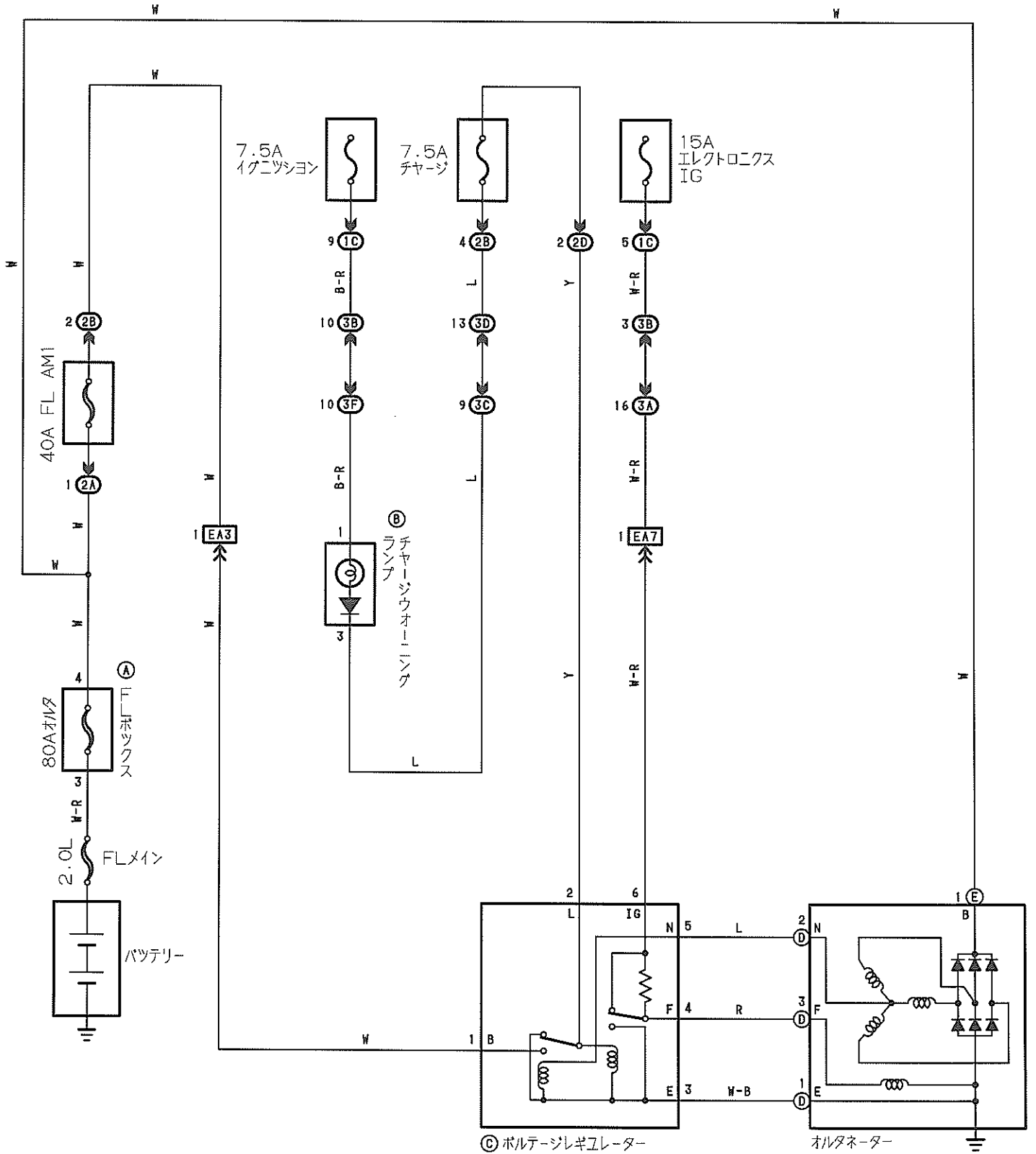

Ⓐ 黑色

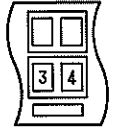

(J/B NO.2)

Ⓑ 灰色

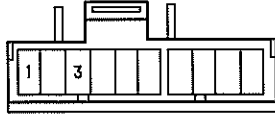

Ⓒ 黑色

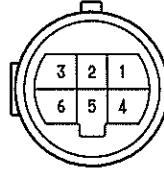

Ⓓ 黑色

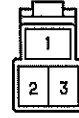

Ⓔ



1C

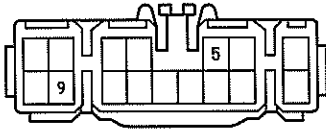

2A 黑色



2B 黑色

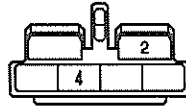

2D 灰色



3A

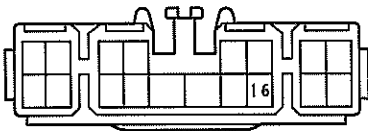

3B



3C

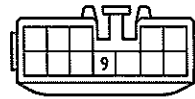

3D

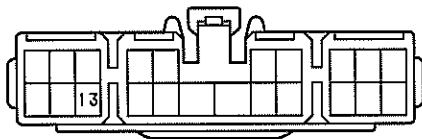

3F

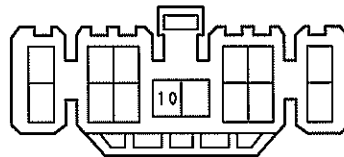

EA3 灰色

EA7 灰色

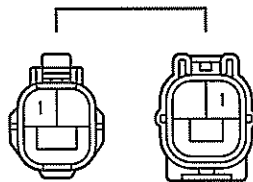
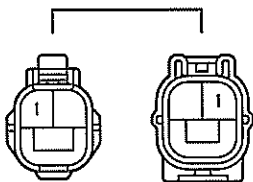

充電(1G-FE)

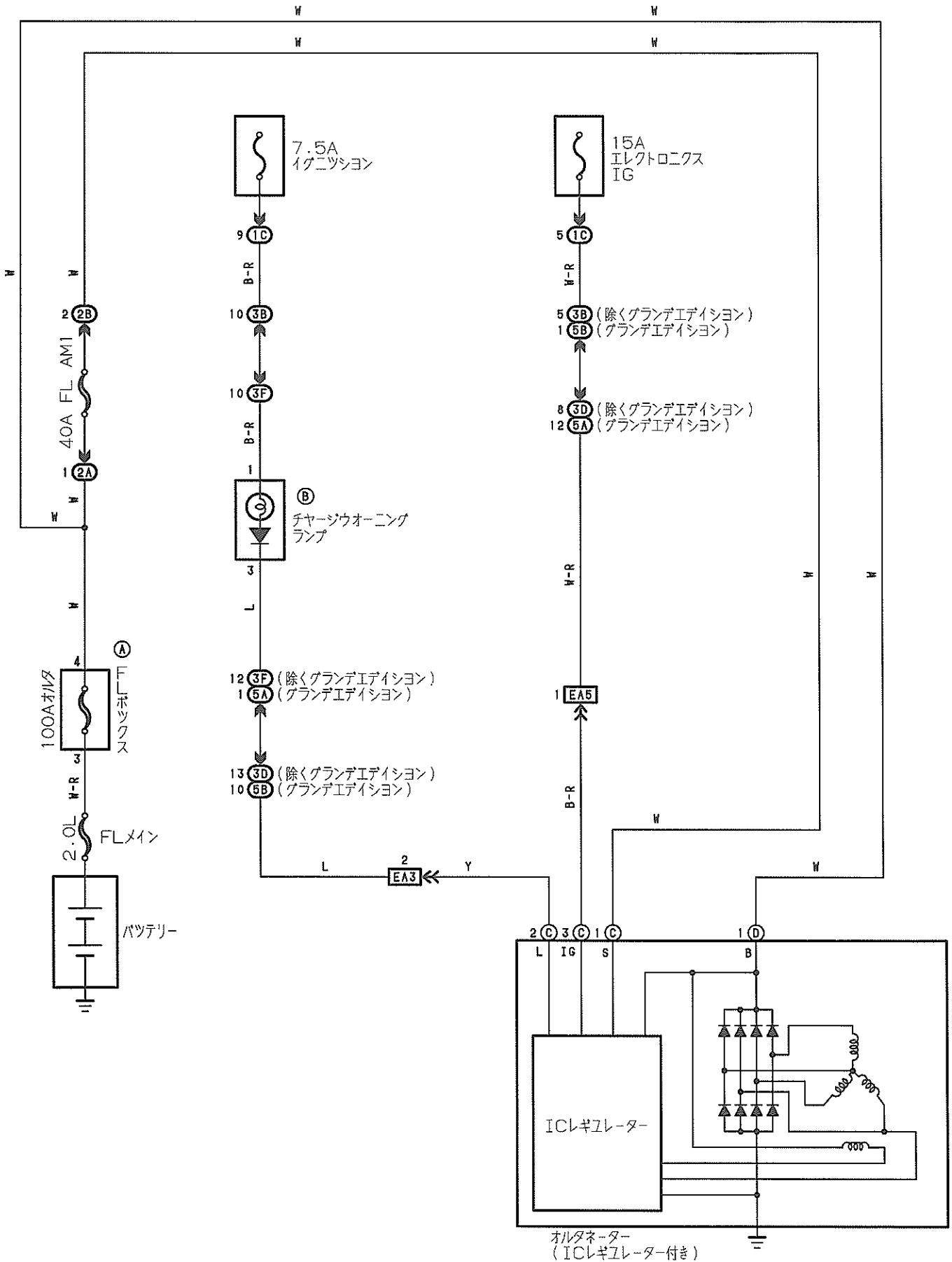



Ⓐ 黑色



(J/B NO.2)

Ⓑ 灰色

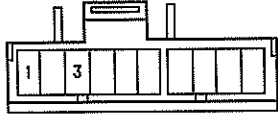

Ⓒ 黑色

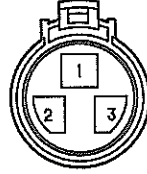

Ⓓ



1C

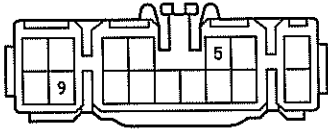

2A 黑色



2B 黑色

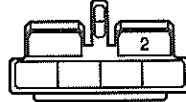

3B 5B

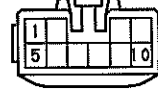

3D

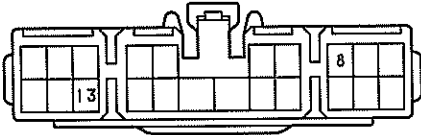

3F

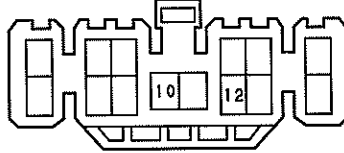

5A

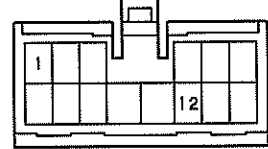

EA5 灰色

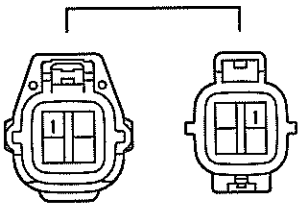

EA6 灰色

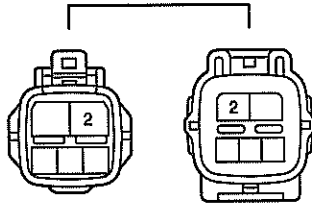

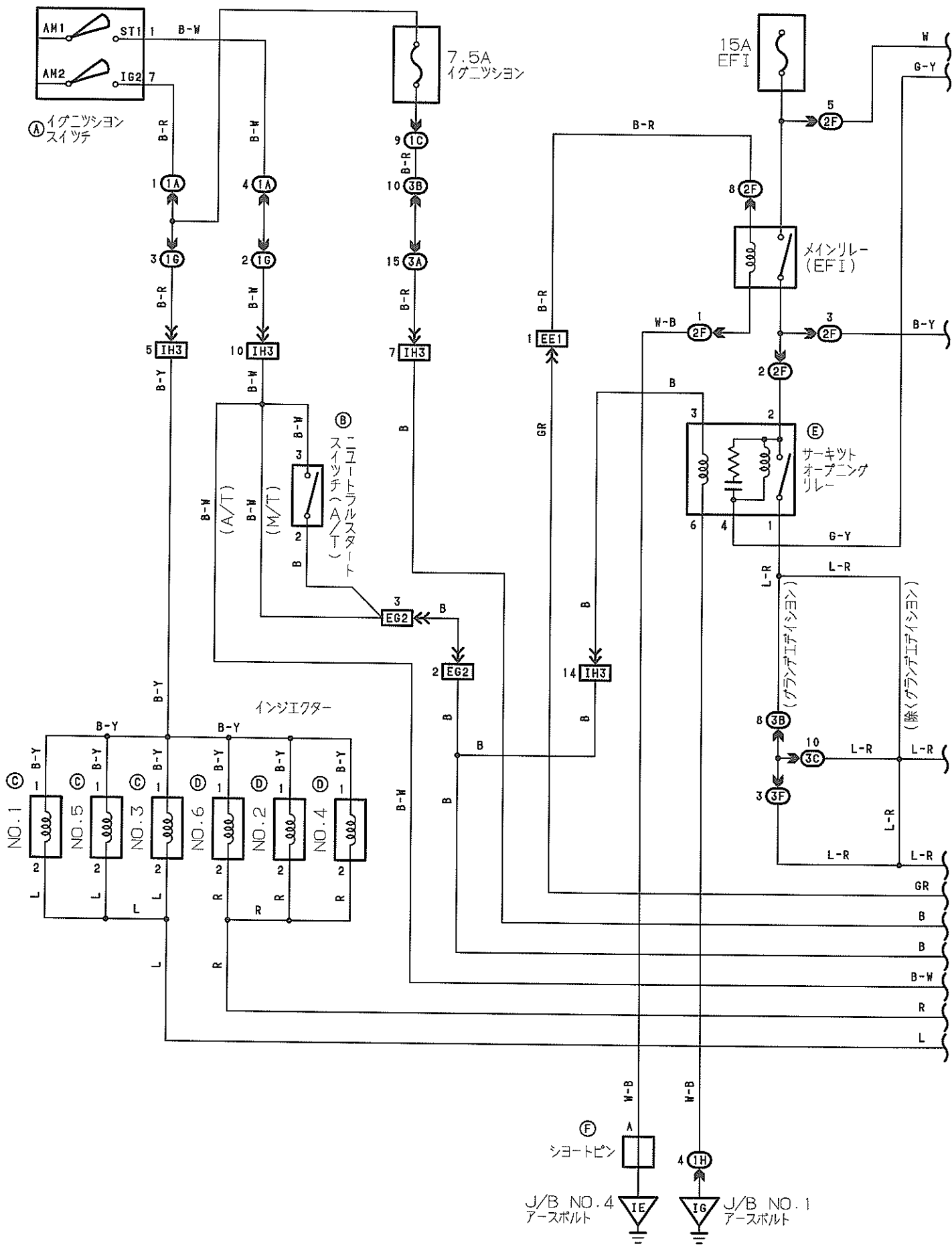

エンジンコントロール
コンピューター

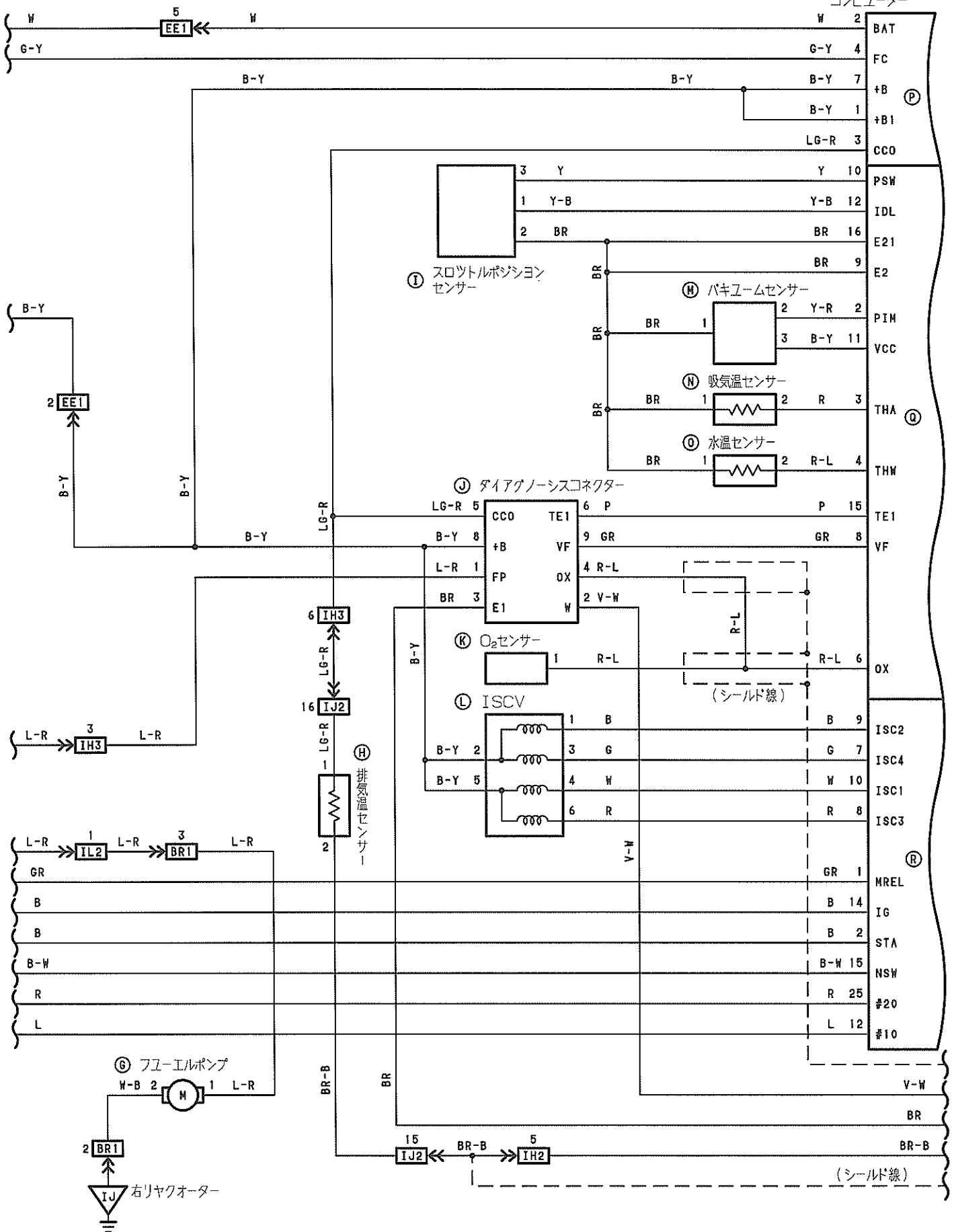

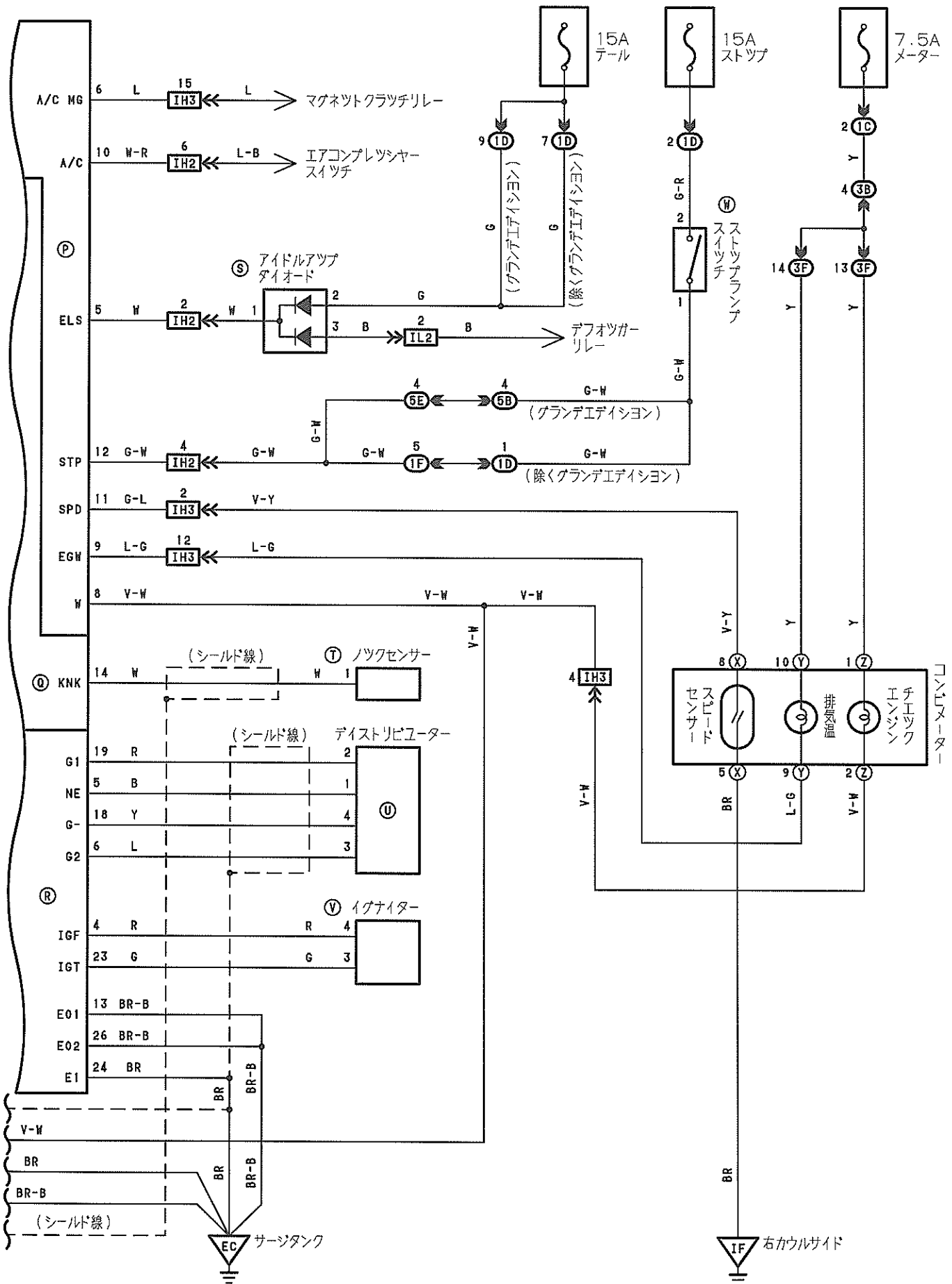

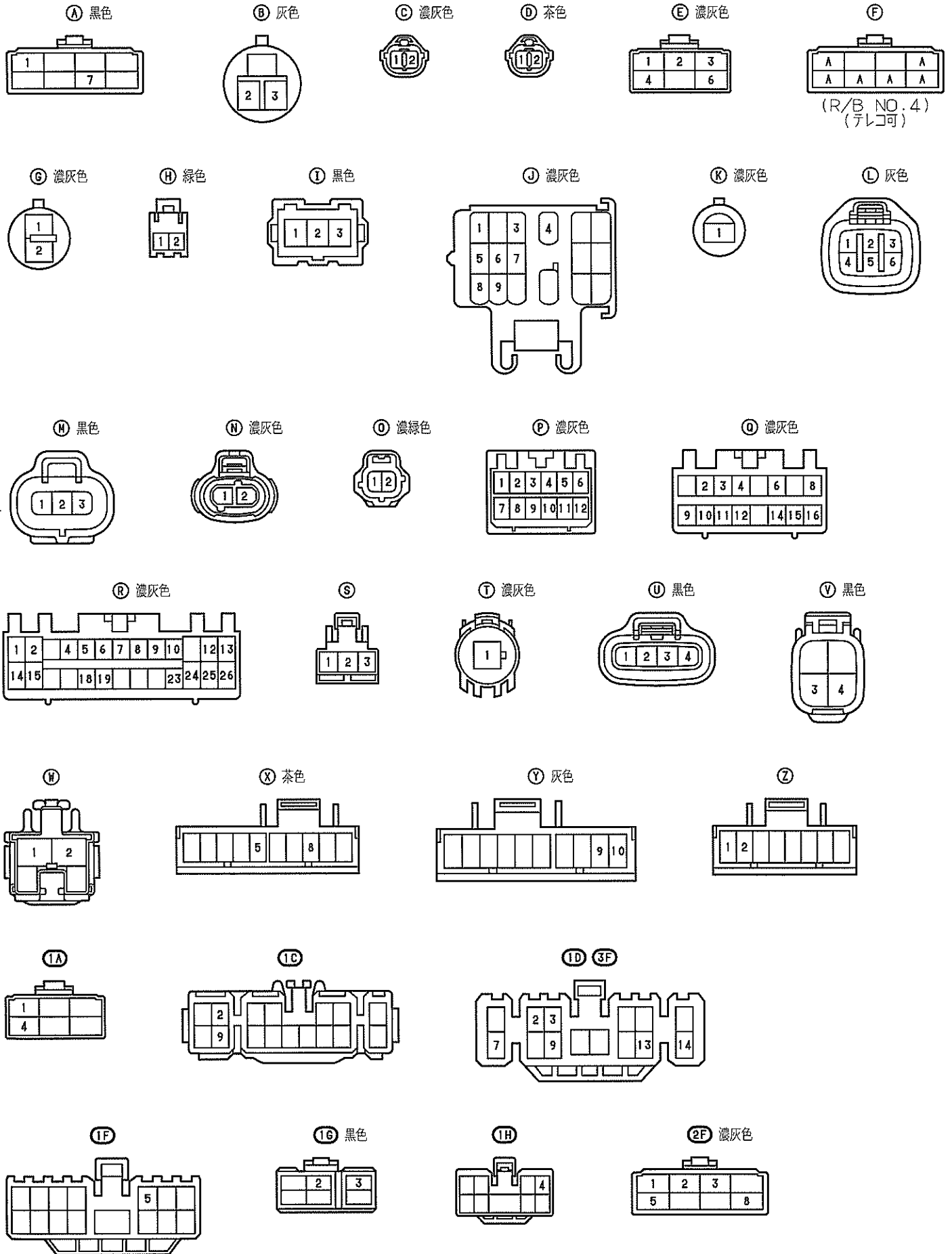

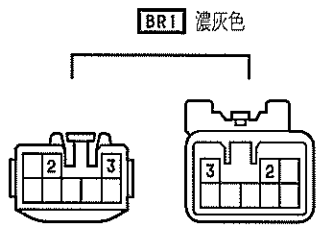
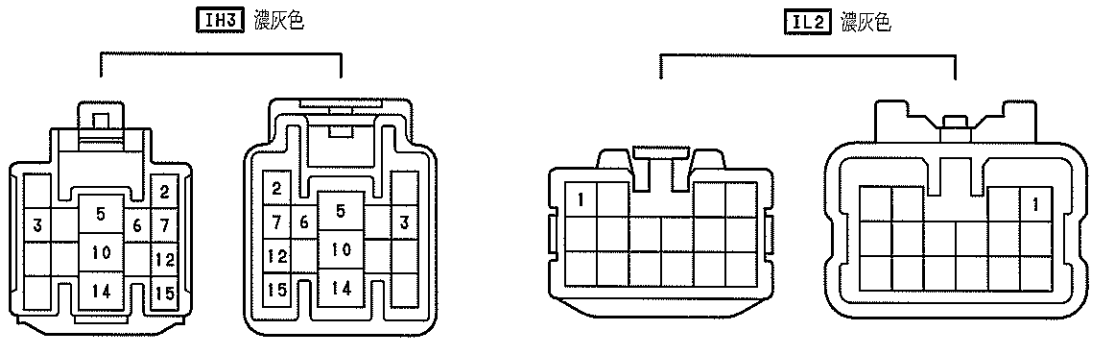
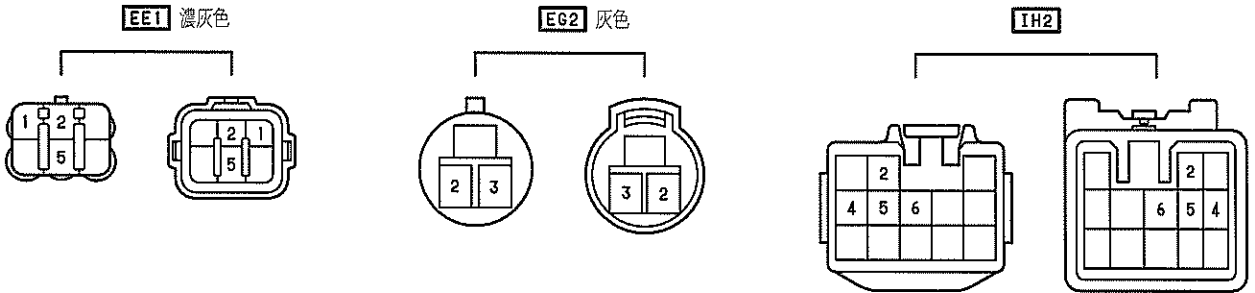
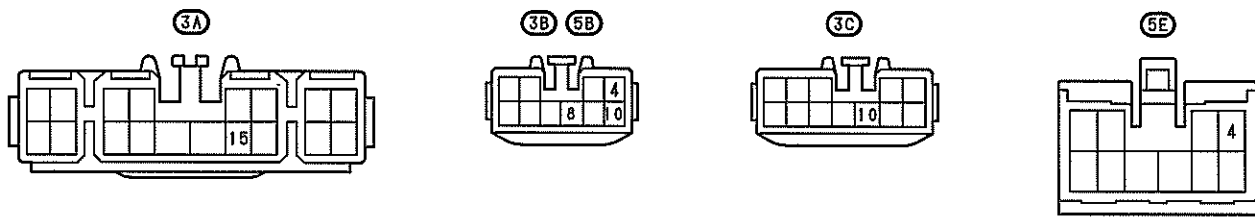

Ⓐ 黒色

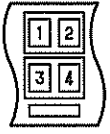

(J/B NO.2)

Ⓑ 黒色

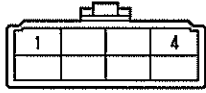

Ⓒ 濃灰色



Ⓓ 濃灰色



Ⓔ 灰色



Ⓕ 灰色



Ⓖ

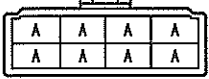

(J/B NO.4)
(テレコ可)

Ⓕ



Ⓖ



Ⓖ



Ⓚ Ⓛ



Ⓜ 濃緑色



Ⓝ

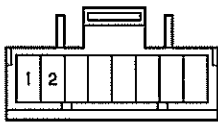

Ⓛⓐ 黒色

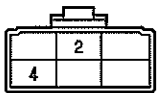

ⓁⒸ

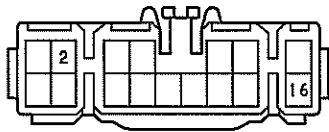

ⓁⒹ 黒色

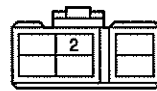

ⓁⒿ 黒色

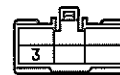

ⓁⒿⓐ 黒色



Ⓛⓑ 黒色

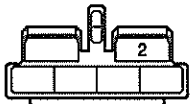

ⓁⒿⓐ

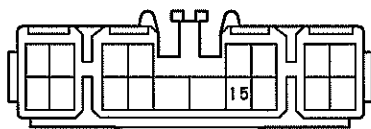

Ⓛⓑ

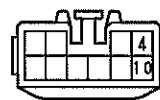

Ⓛⓑ

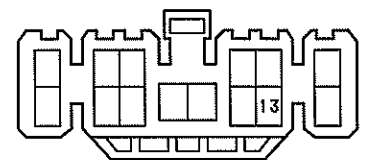

ⓁⒿⒶ 灰色

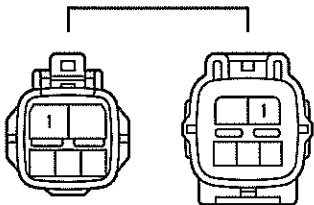

ⓁⒿⒶ 灰色

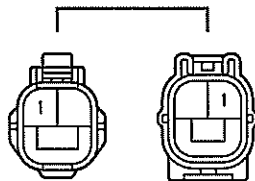

ⓁⒿⒶ 黒色

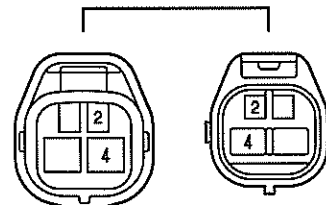

ⓁⒿⒶ

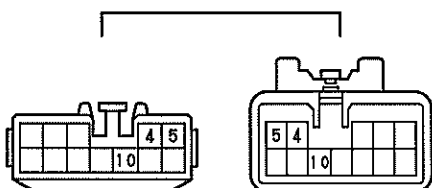

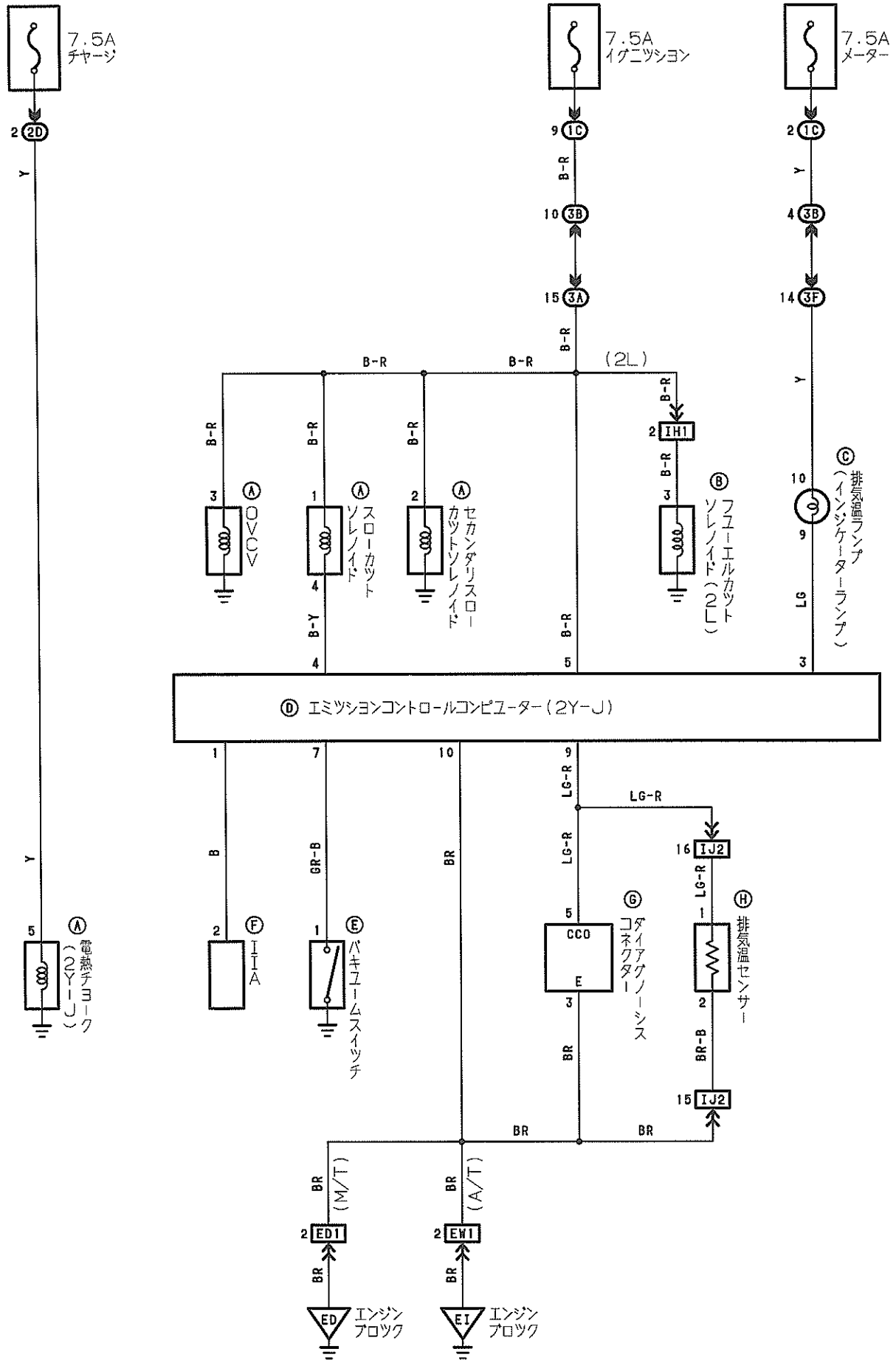



Ⓐ 濃灰色

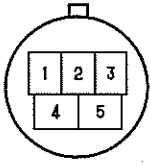

Ⓑ 灰色



Ⓒ 灰色

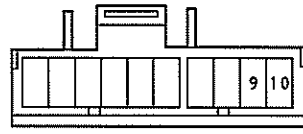

Ⓓ 濃灰色

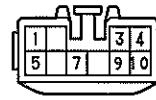

Ⓔ 灰色



Ⓕ 緑色

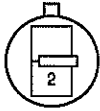

Ⓖ 黒色

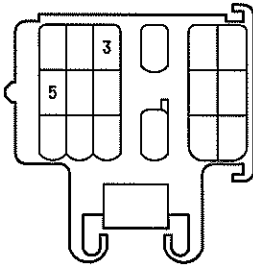

Ⓖ 緑色



⓫

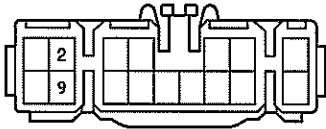

⓫

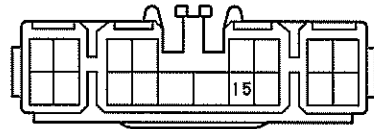

⓫

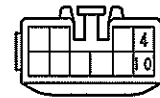

⓫

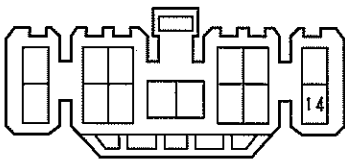

⓫ ⓫ 灰色

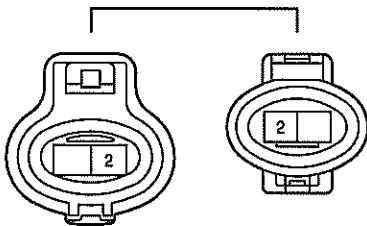

⓫

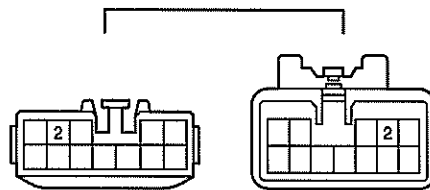

⓫ 濃灰色

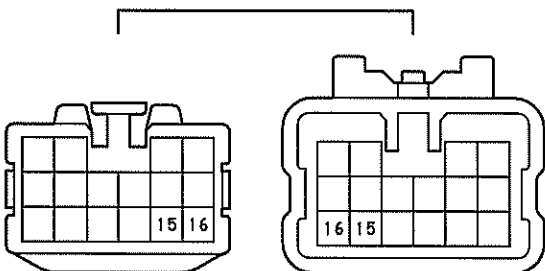



フューエルヒーター (2L)

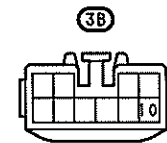
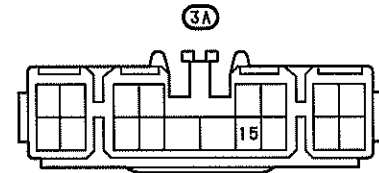
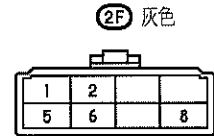
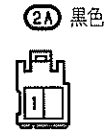
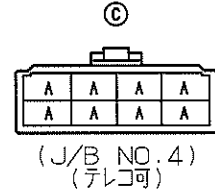
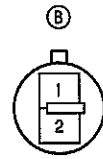
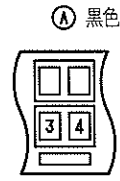
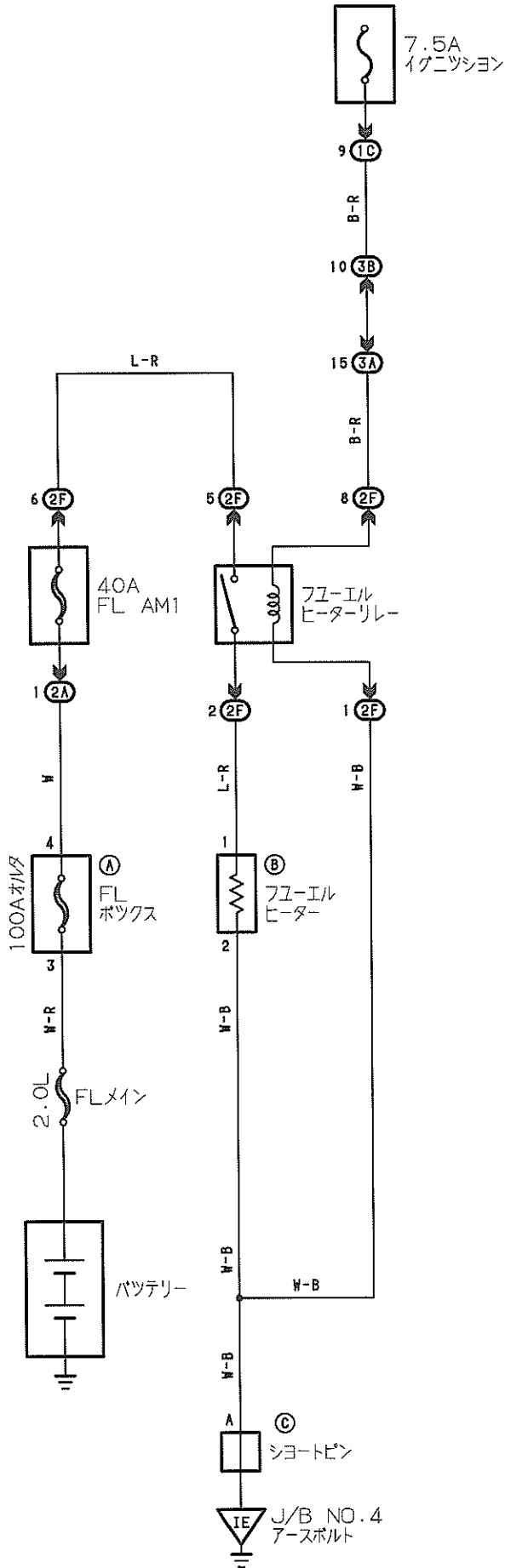

ヘッドランプ

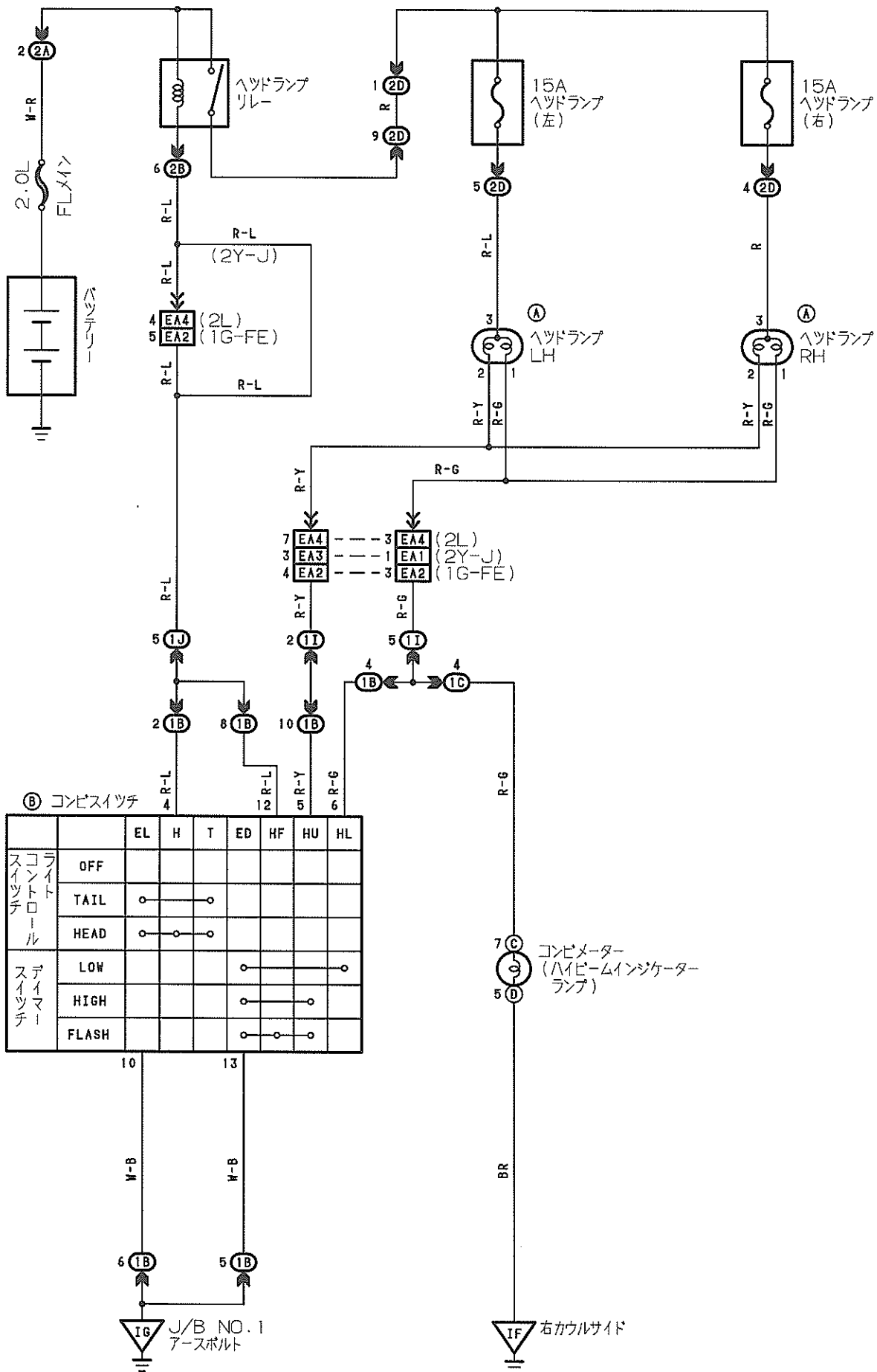

② コンビスイッチ

		EL	H	T	ED	HF	HU	HL
コン スイ ツチ コ ント ロ ー ル	OFF							
	TAIL	○	○					
	HEAD	○	○					
ス イ ツ チ メ ー タ	LOW				○	○	○	○
	HIGH				○	○	○	○
	FLASH				○	○	○	○

① 灰色

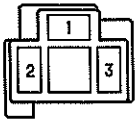

② 黒色

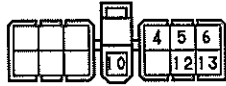

③ 青色

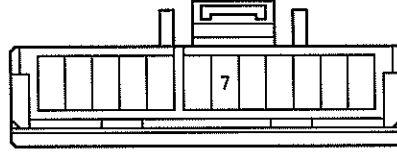

④ 茶色

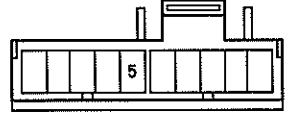

①B



①C

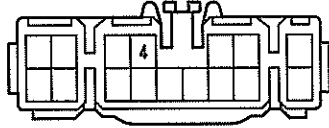

①I 黒色

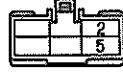

①J



②A 黒色



②B 黒色

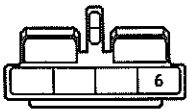

②D 灰色

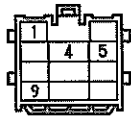

EA1 灰色

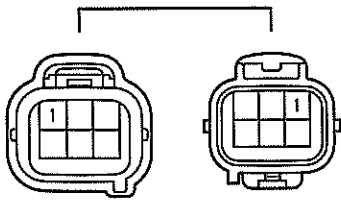

EA2 灰色

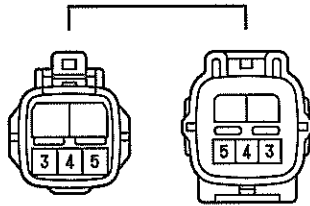

EA3 灰色

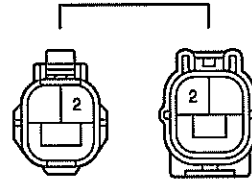

EA4 灰色

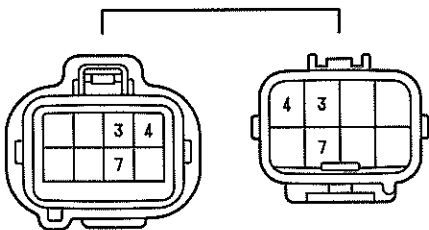

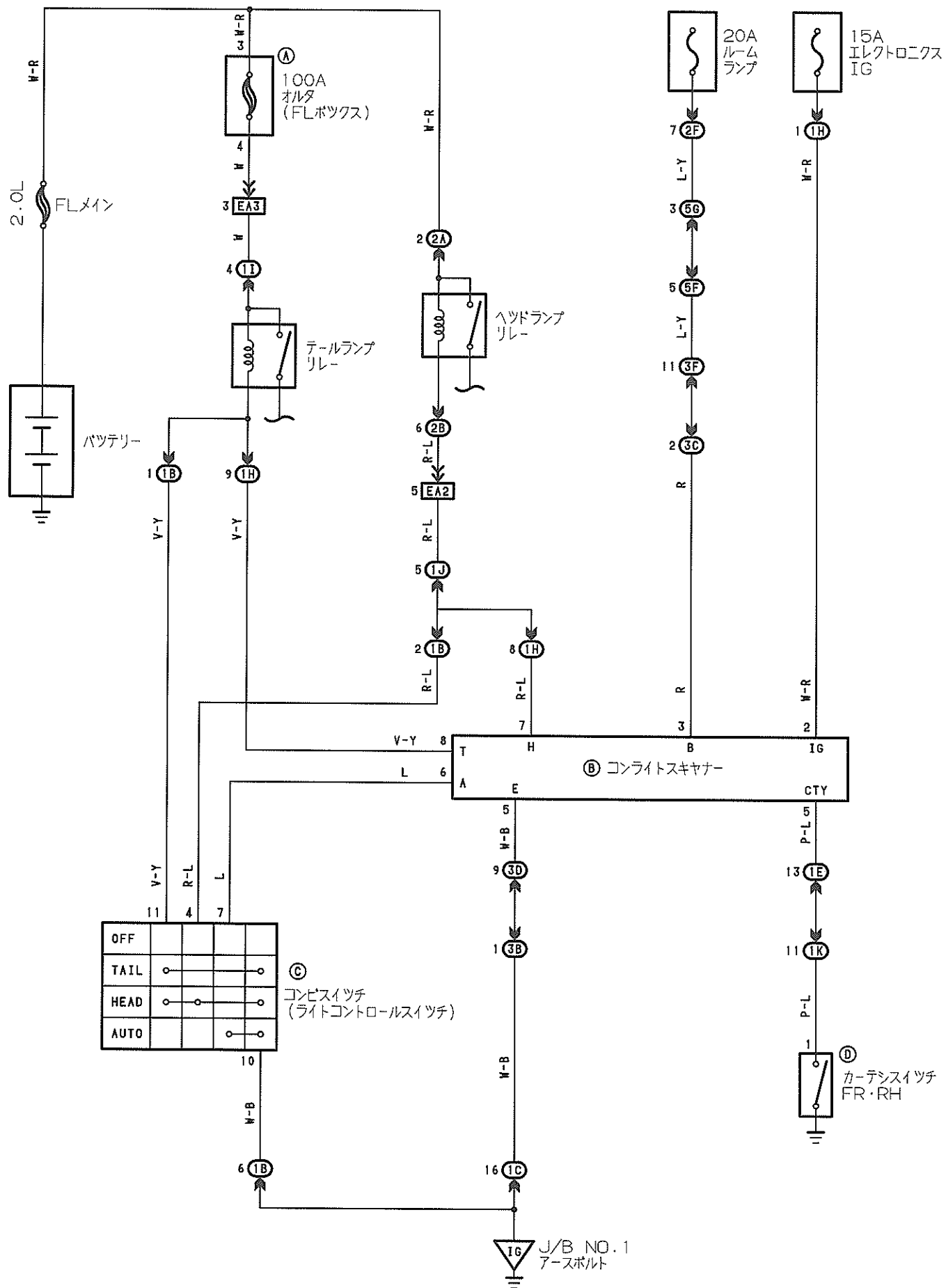

① 黒色



(J/B NO.2)

②

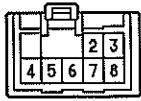

③ 黒色

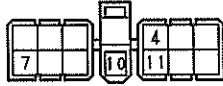

④



①B ③B

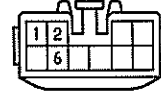

①C

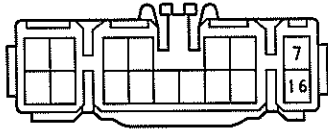

①E

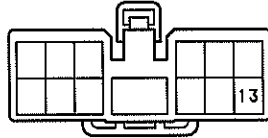

①H

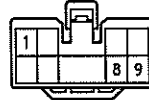

①I

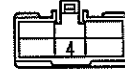

①J 黒色



①K

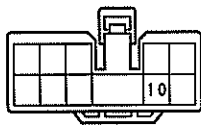

②A 黒色



②B 黒色

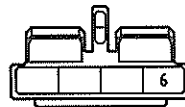

②F 濃灰色

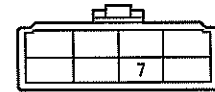

③C ⑤G



③D

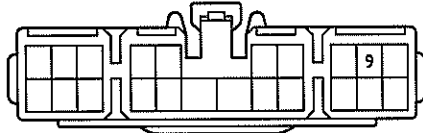

③F ⑤F

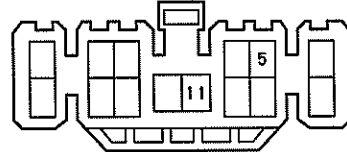

EA2 灰色

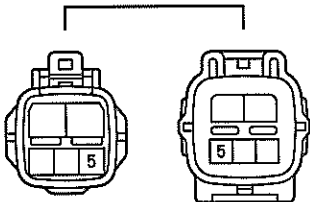

EA3 灰色

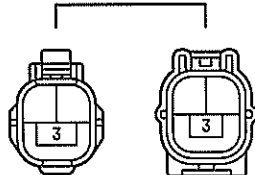

○ ランプフェイリアなし
 △ ランプフェイリア付き

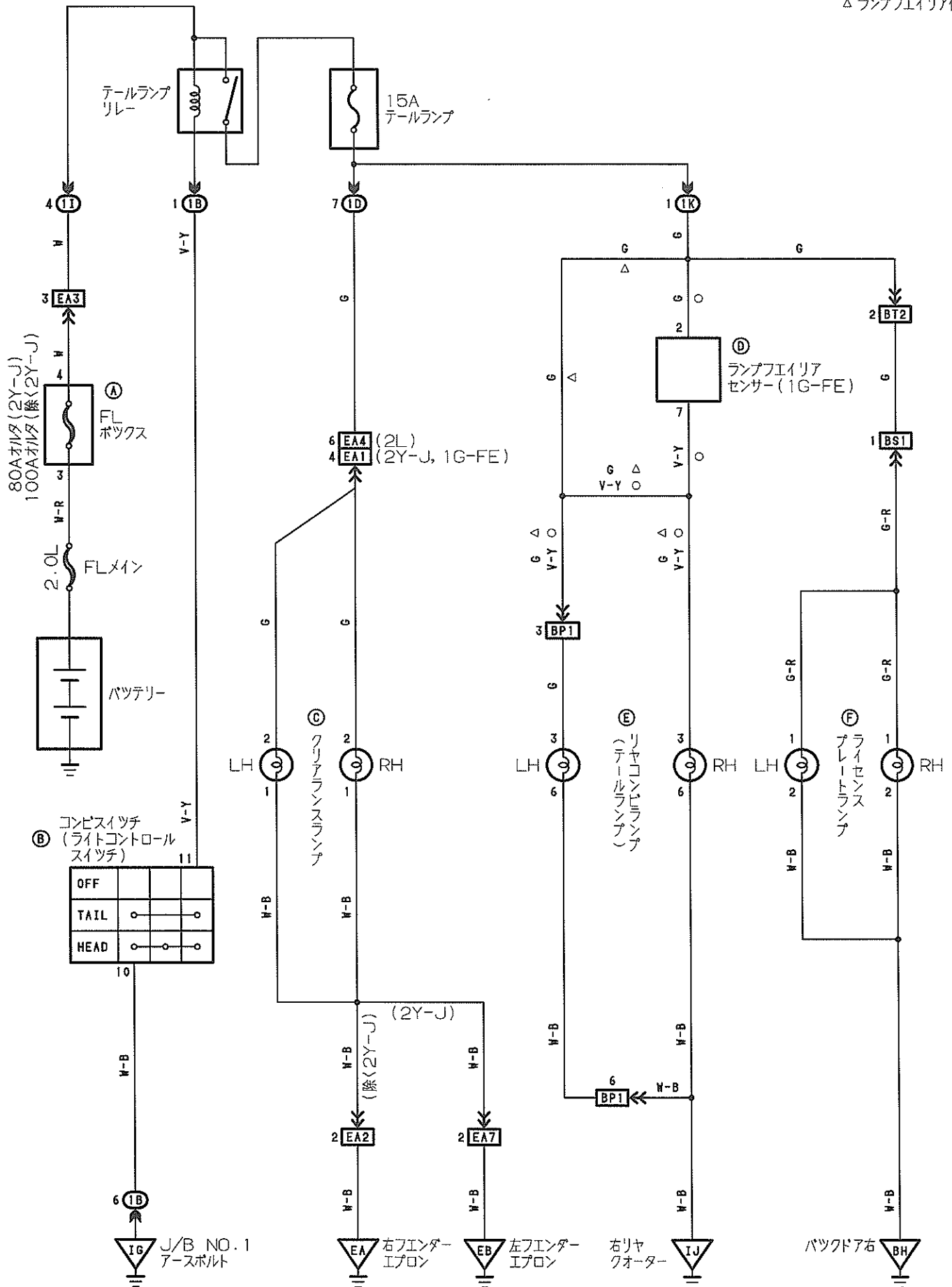

Ⓐ 黒色



(J/B NO.2)

Ⓑ 黒色

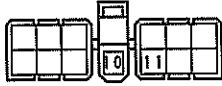

Ⓒ 灰色

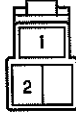

Ⓓ



Ⓔ



Ⓕ



ⓑ

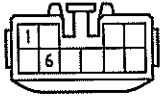

ⓓ

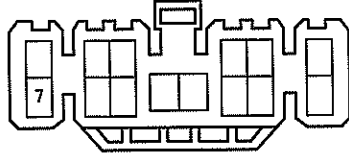

ⓓ 黒色



ⓓ

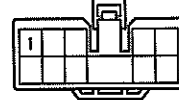

EA1 灰色

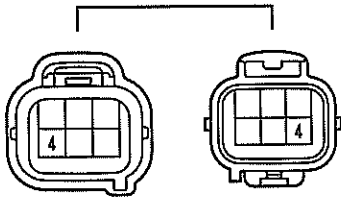

EA2 灰色

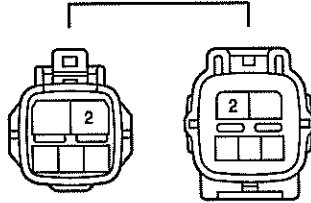

EA3 EA7 灰色

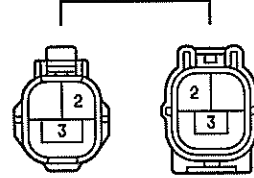

EA4 灰色

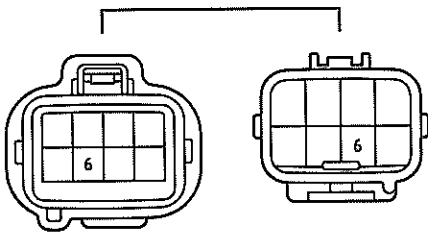

BP1

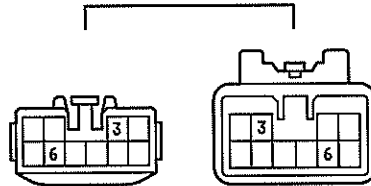

BS1

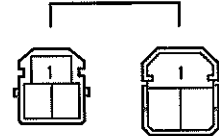

BT2

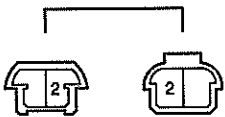

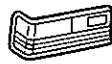

- 除く1G-FEグラndeアイシヨシ
- △ 1G-FEグラndeアイシヨシ
- 2Y-J, 1G-FE

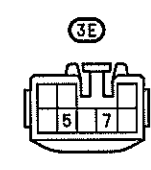
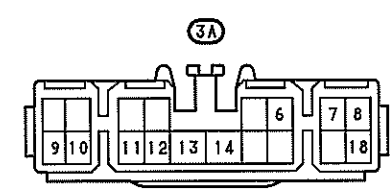
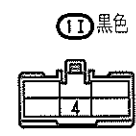
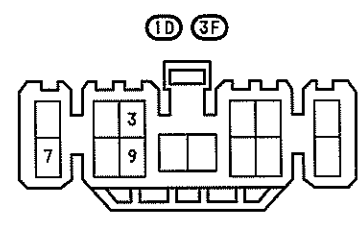
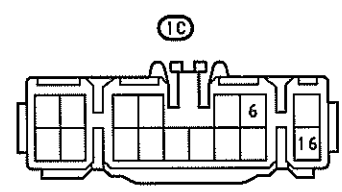
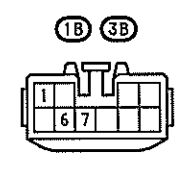
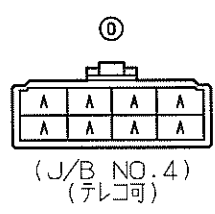
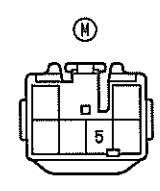
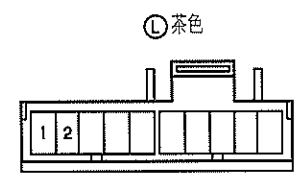
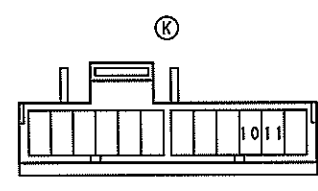
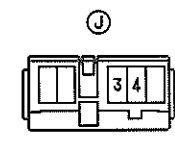
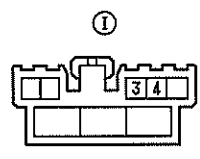
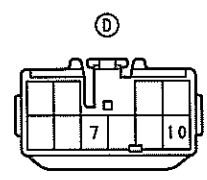
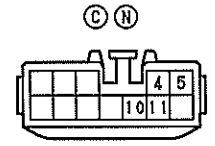
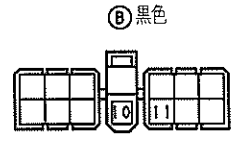
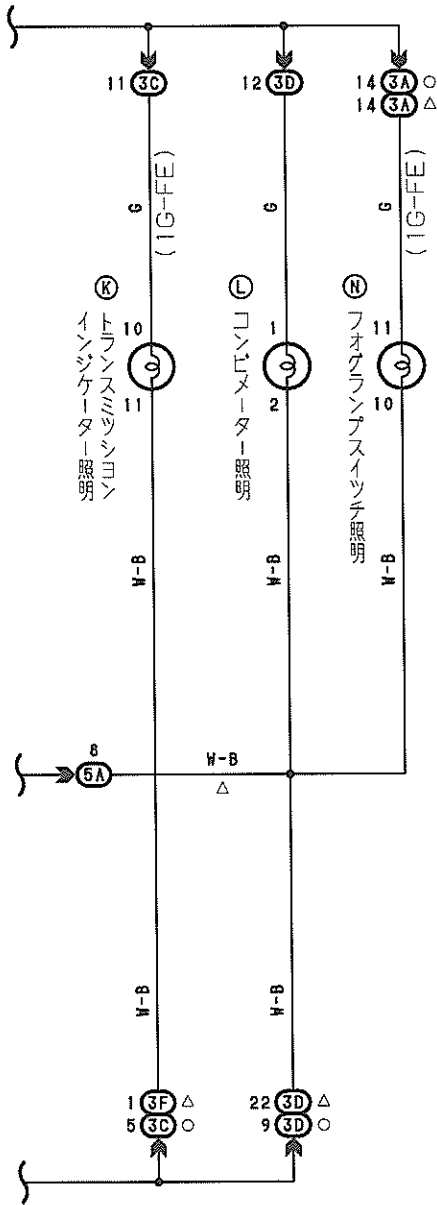

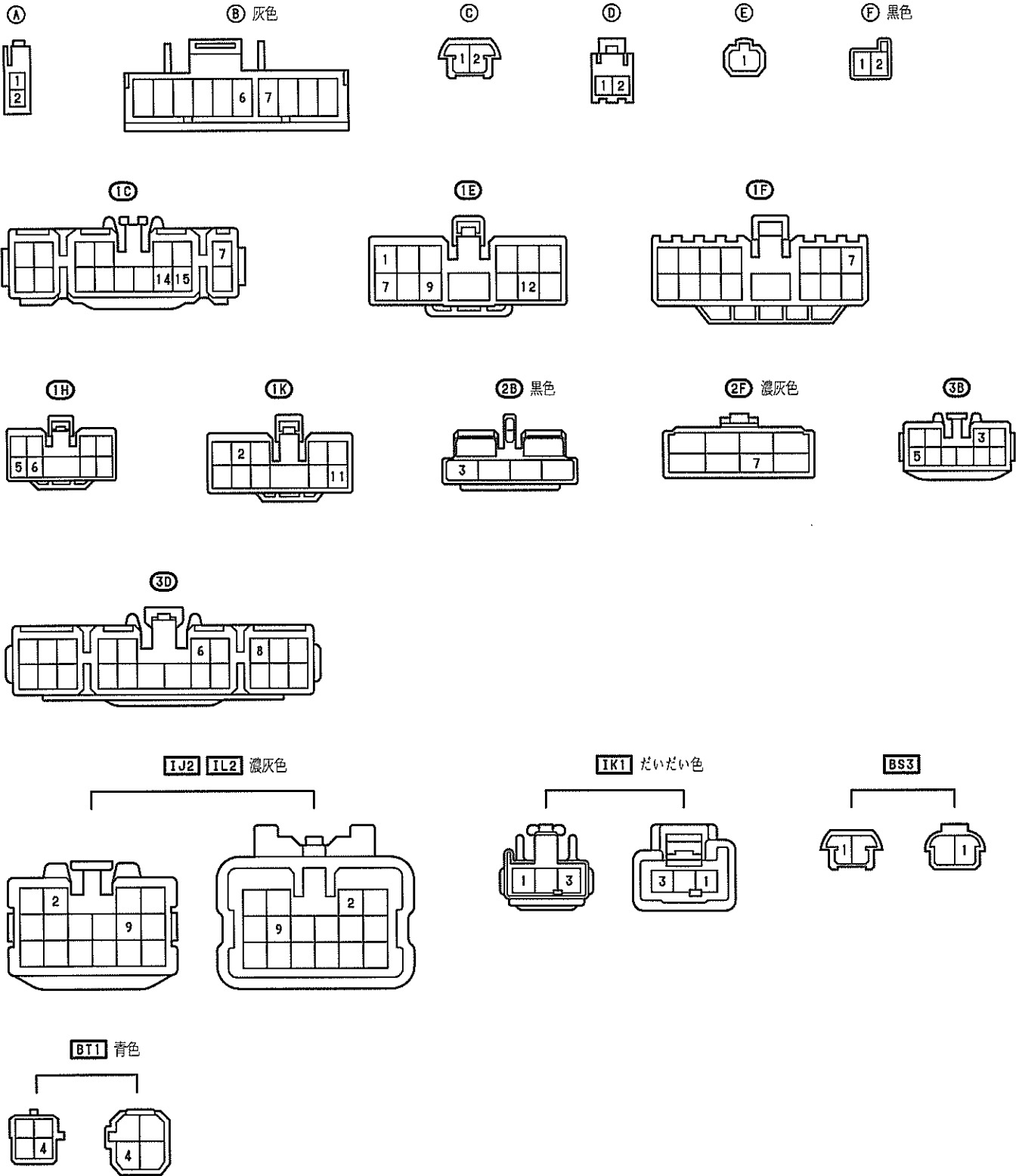

インテリアランプ (ワゴン)

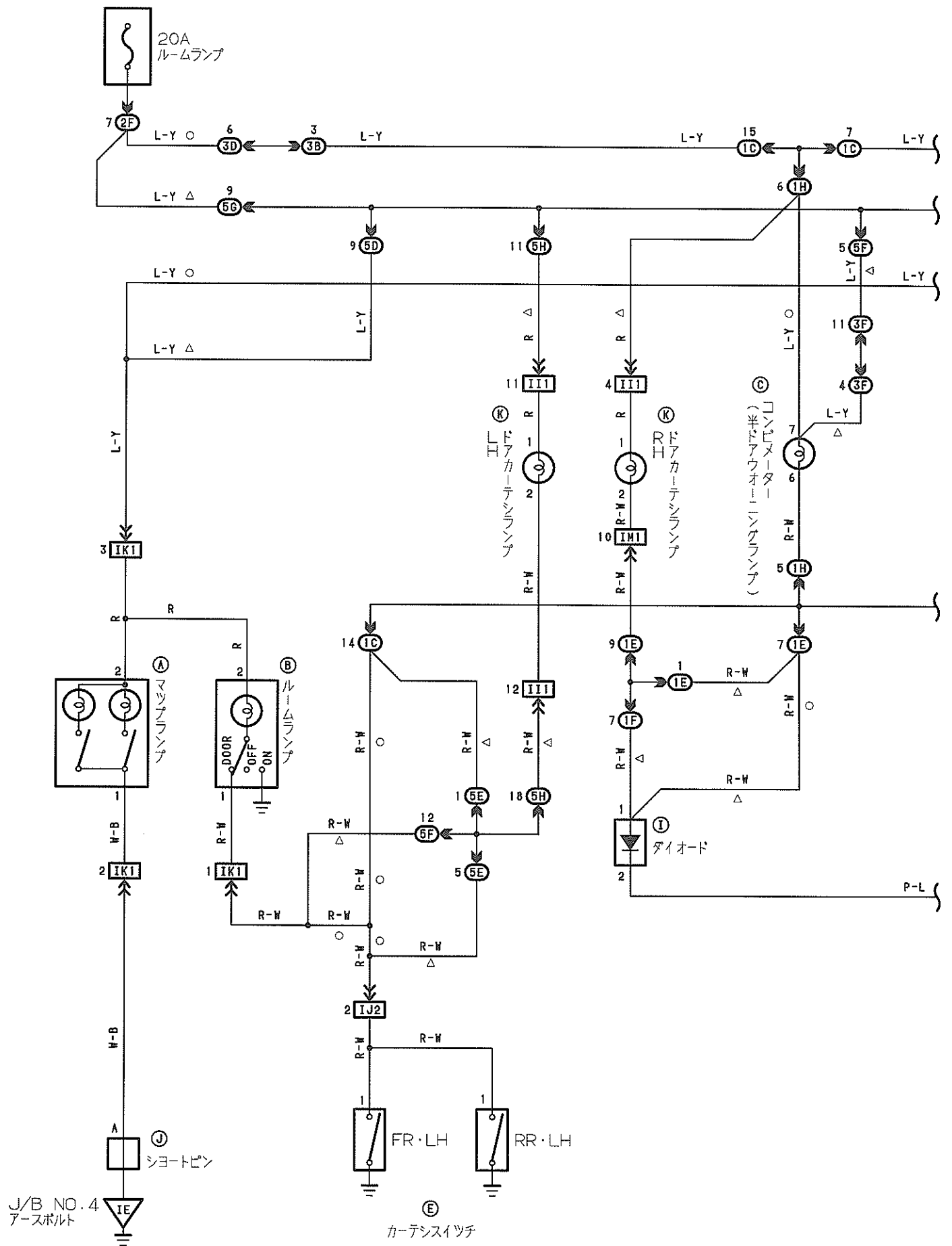



○ 除くグラウンデーション
△ グラウンデーション

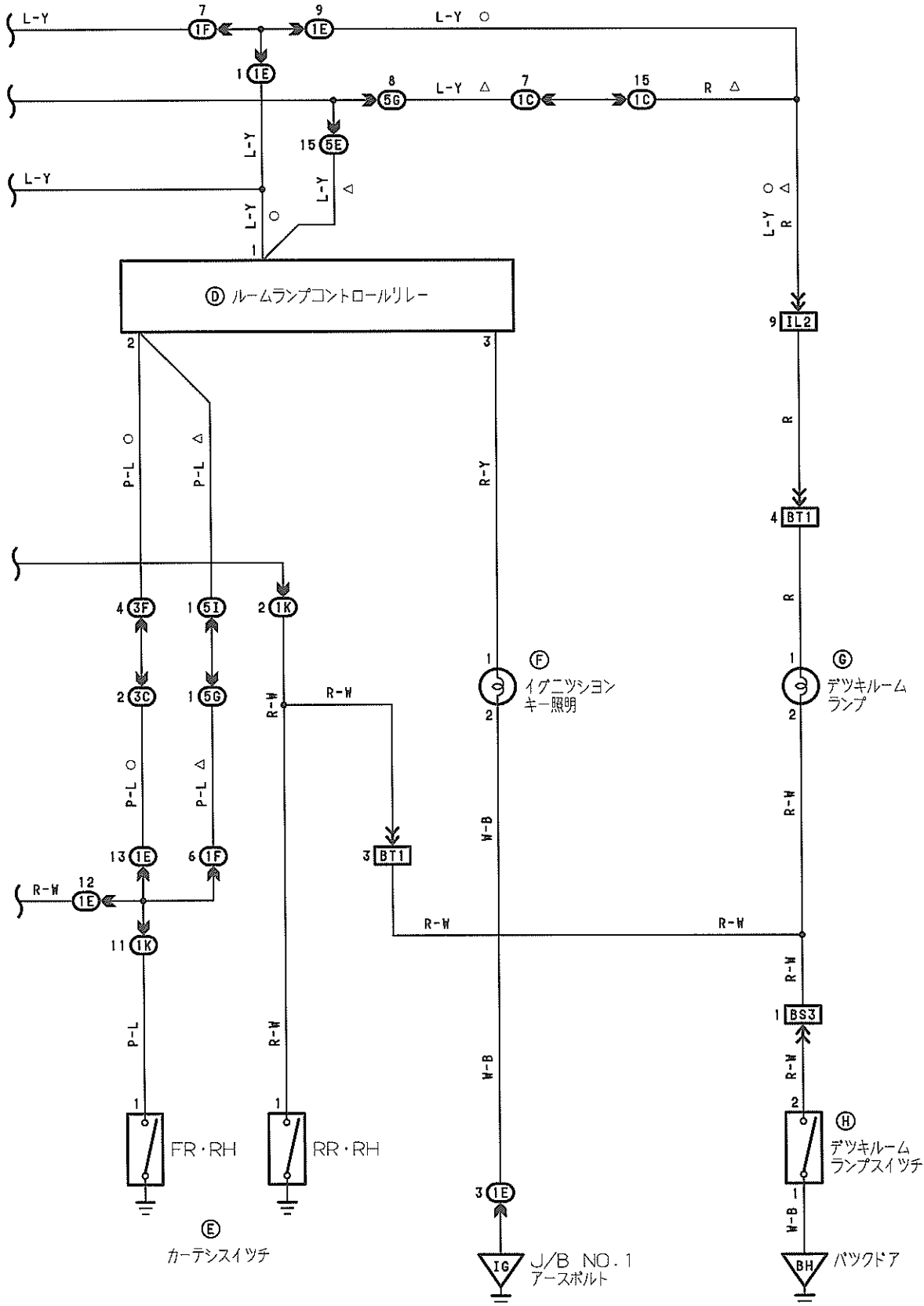

インテリアランプ (ワゴン)

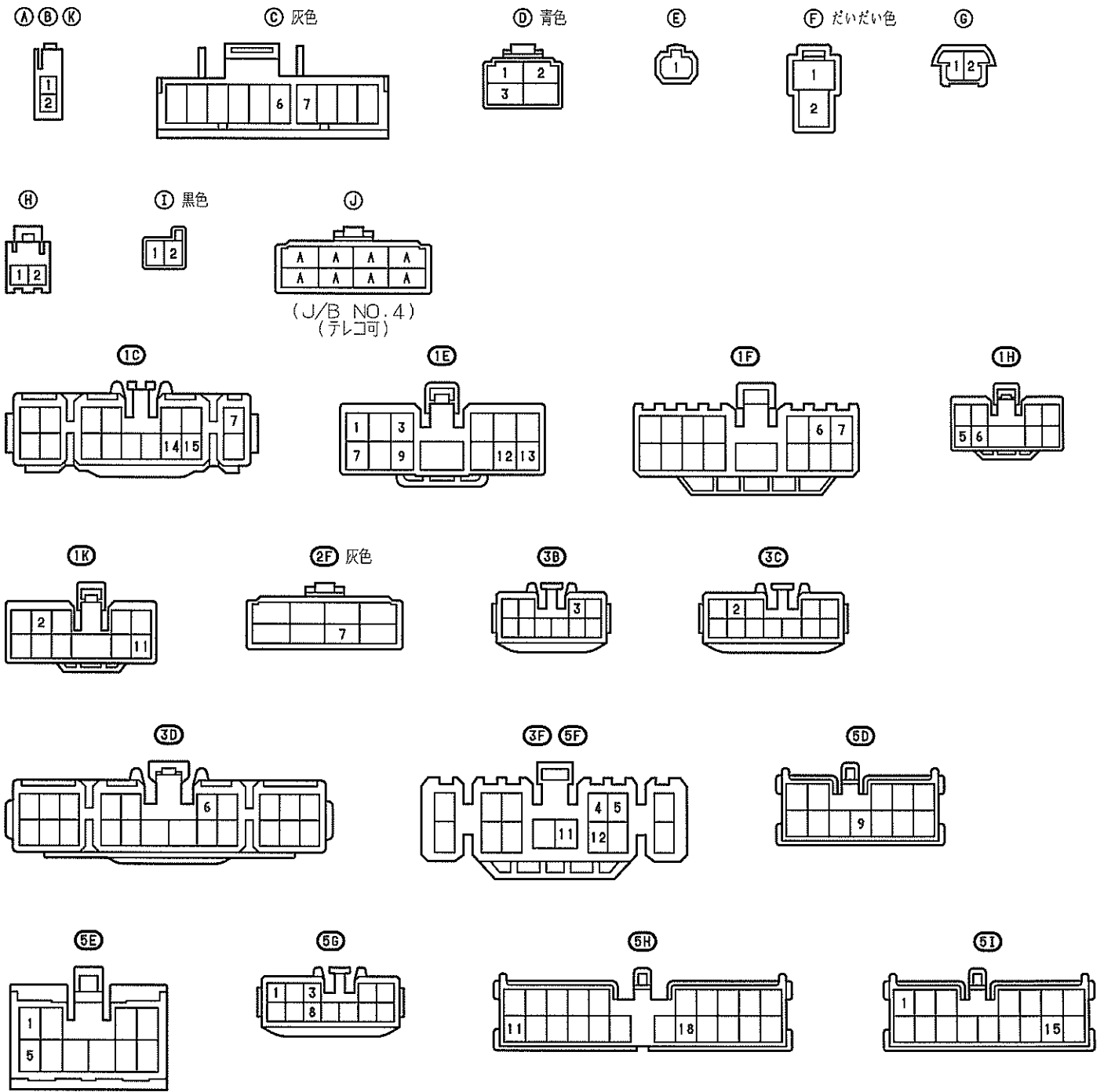



II1 青色

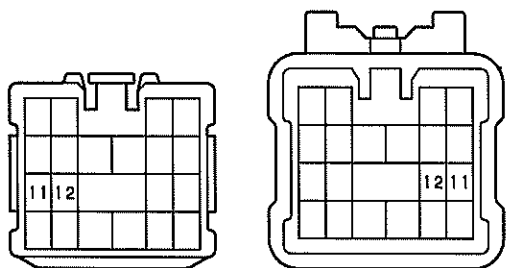

IJ2 IL2 濃灰色

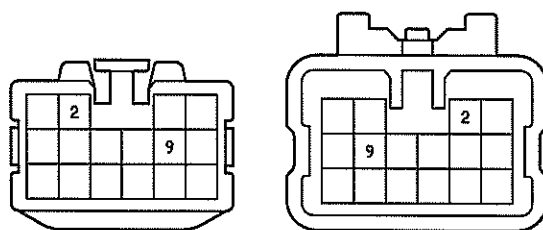

IK1 だいだい色

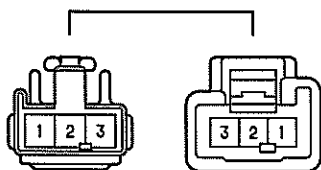

IM1 青色

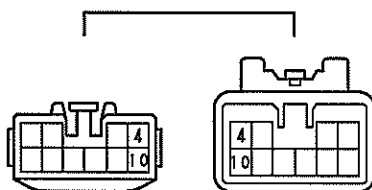

BS3

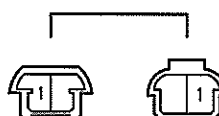

BT1 青色

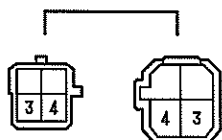

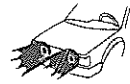

フォグランプ (1G-FE)

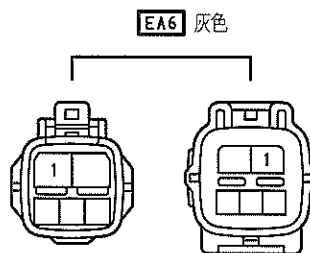
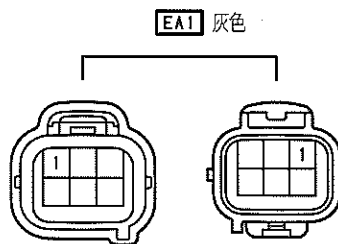
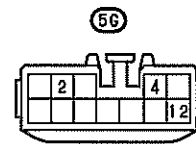
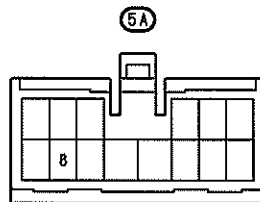
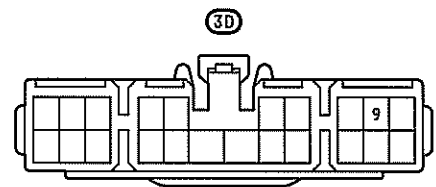
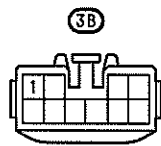
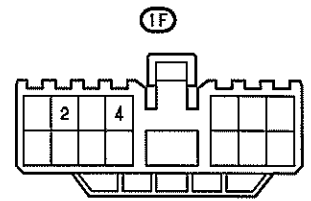
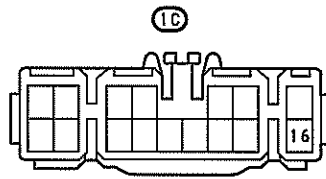
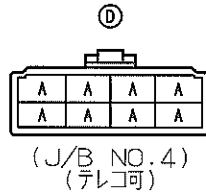
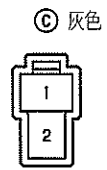
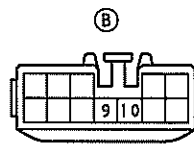
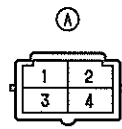
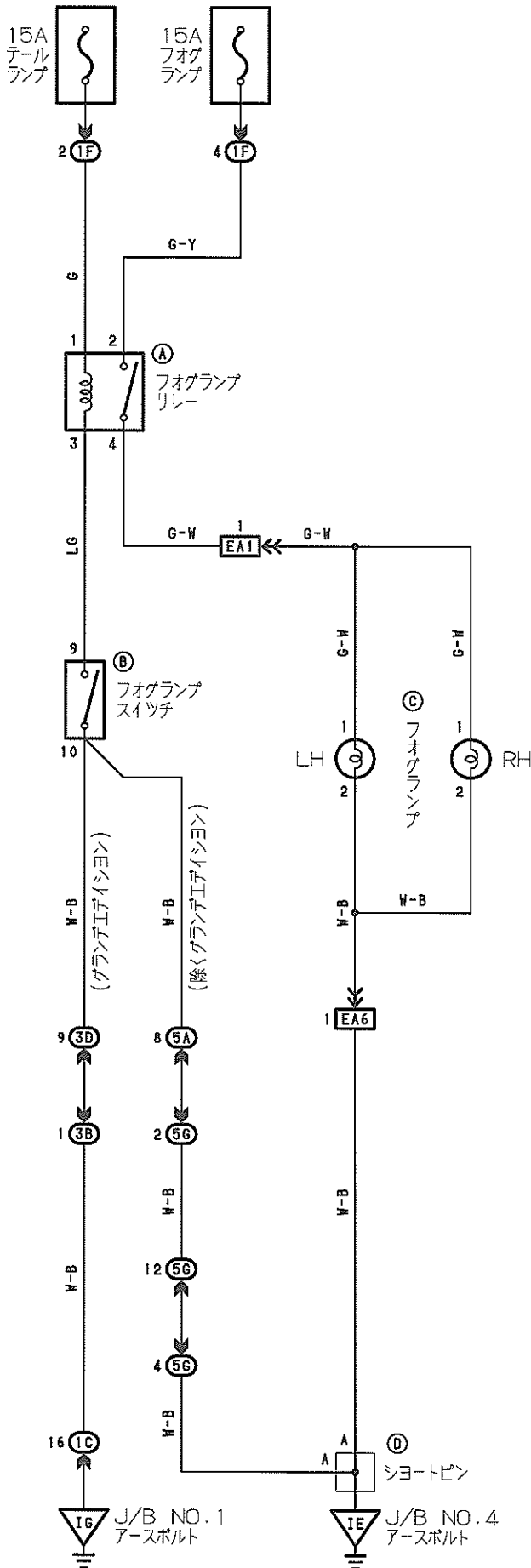

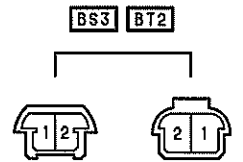
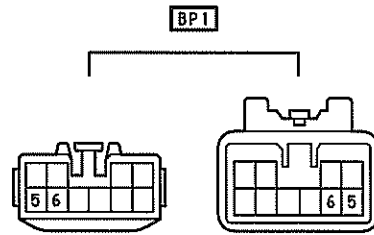
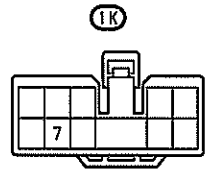
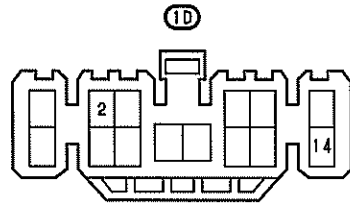
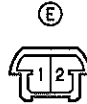
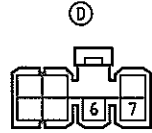
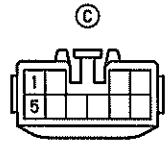
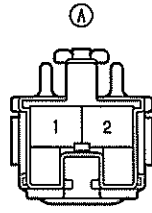
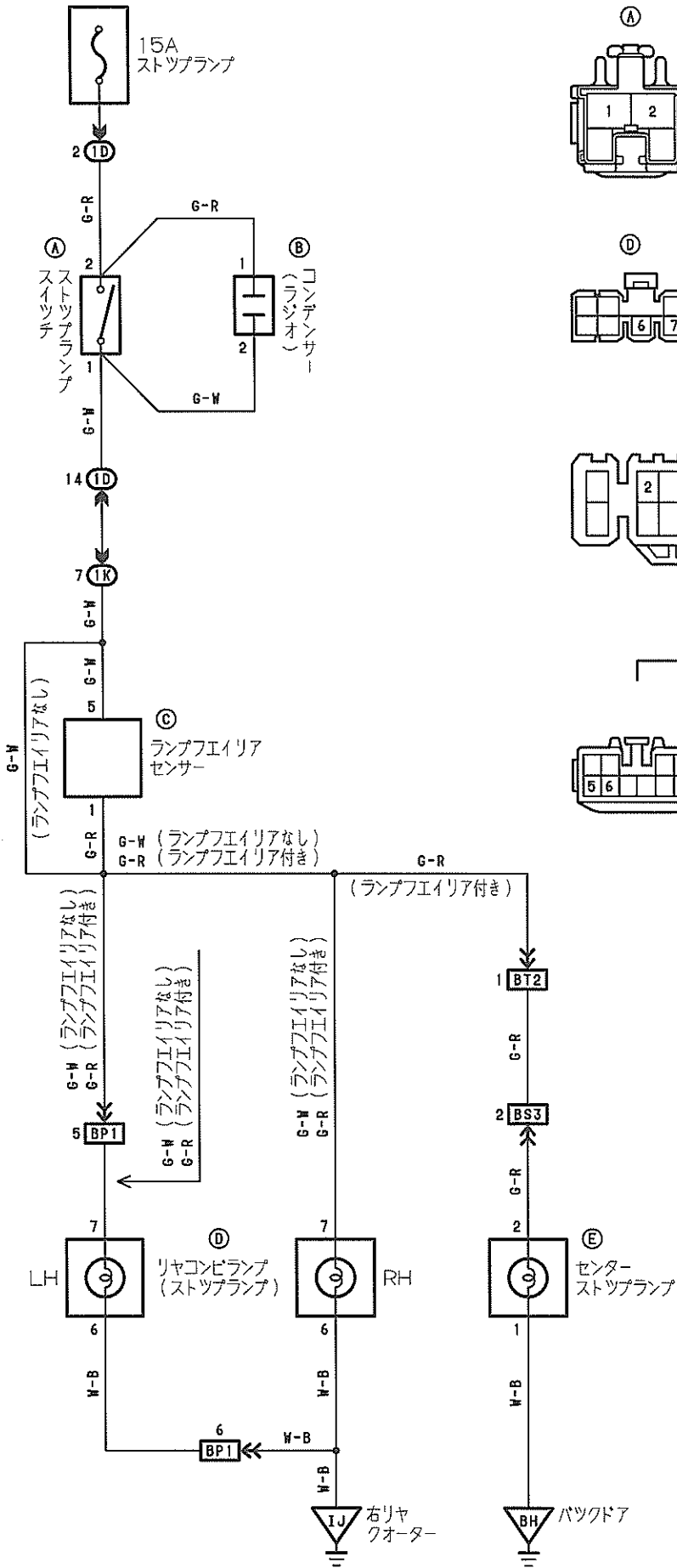

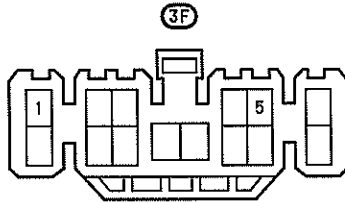
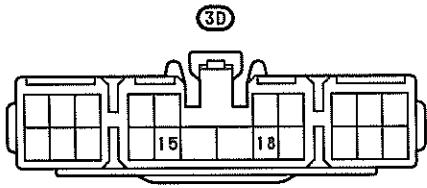

ED2 灰色

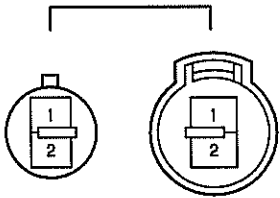

EG1 灰色

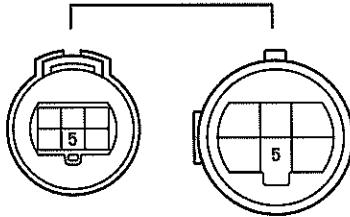

EG2 灰色

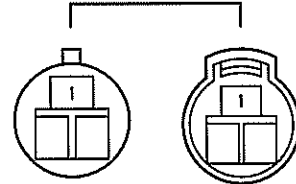

IH1

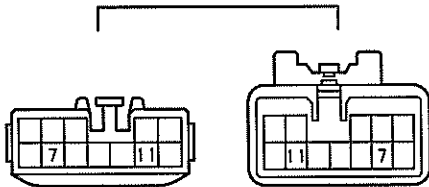

IH3 濃灰色

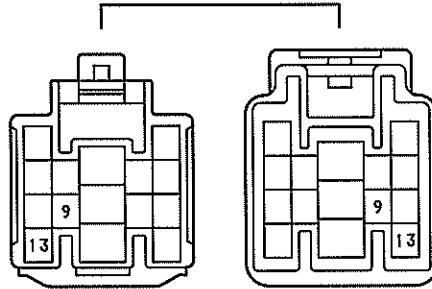

IL2 濃灰色

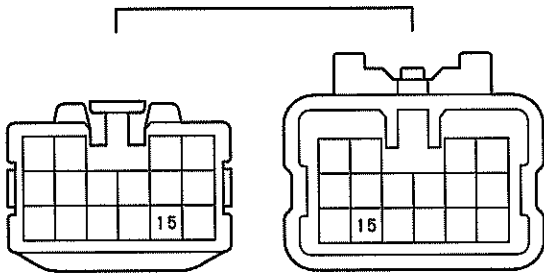

BP1

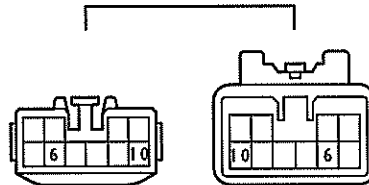



リヤライトウオーニング (1G-FE)

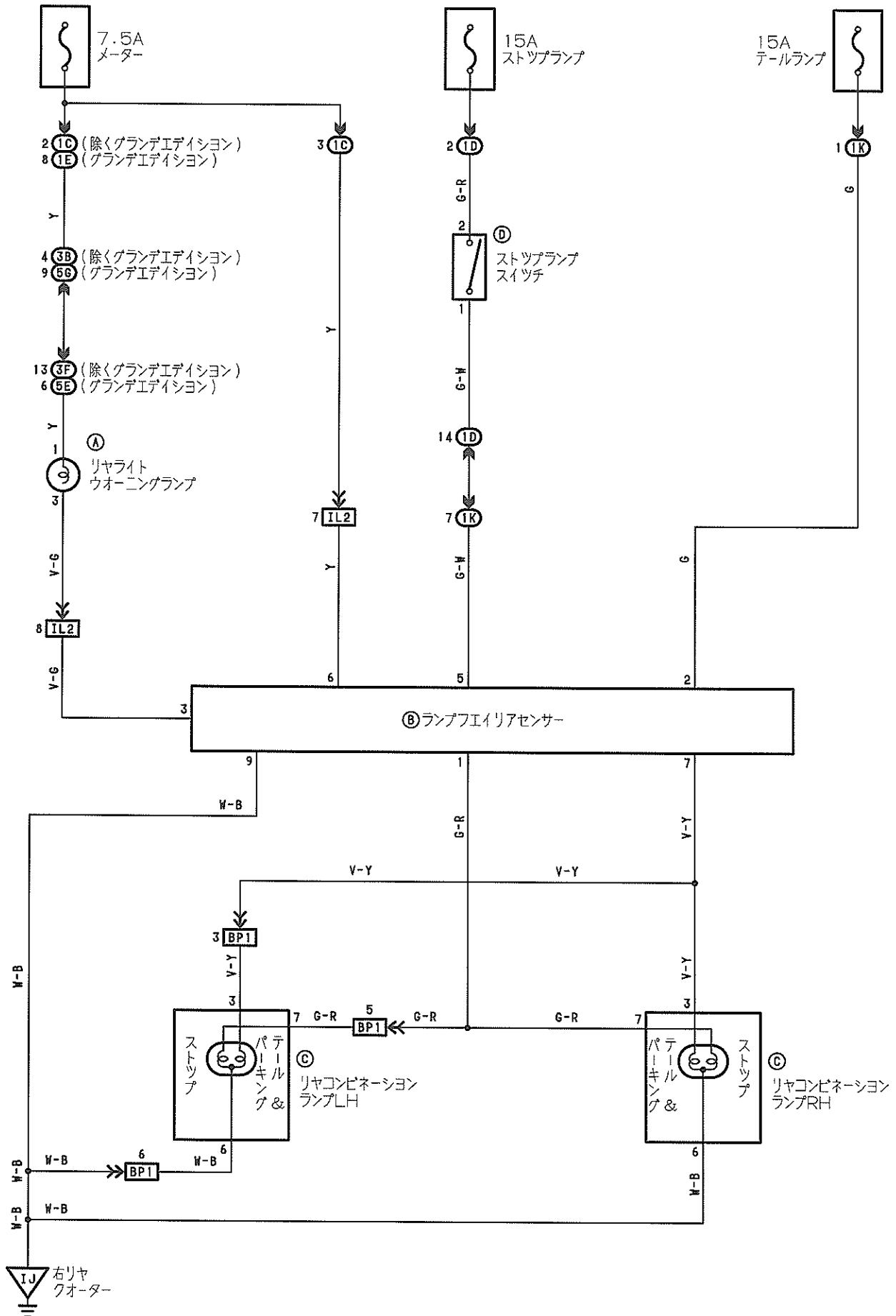

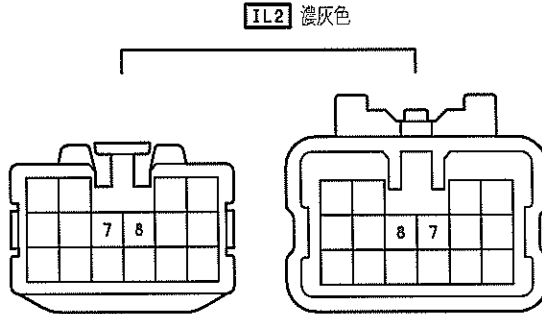
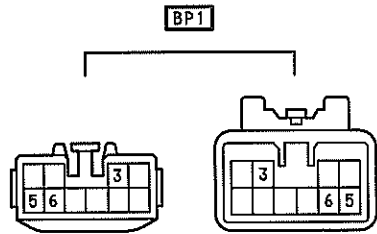
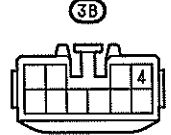
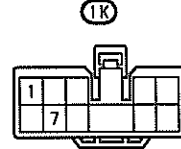
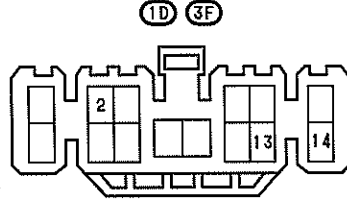
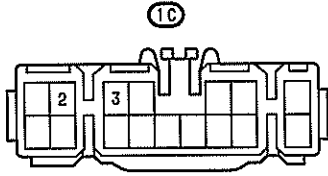
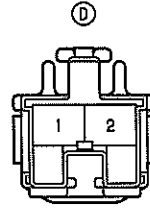
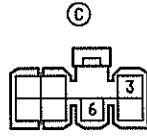
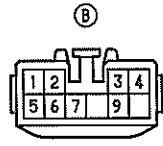
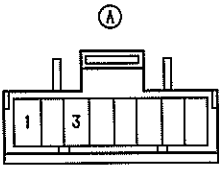

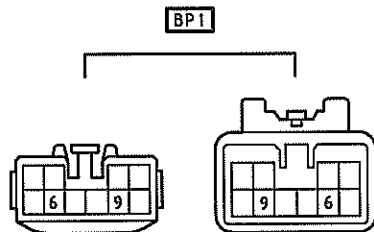
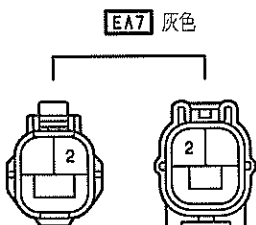
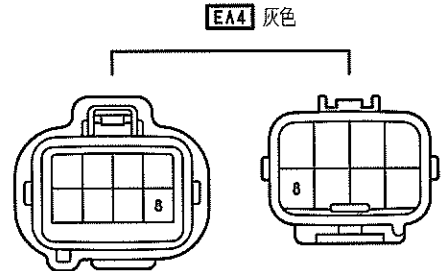
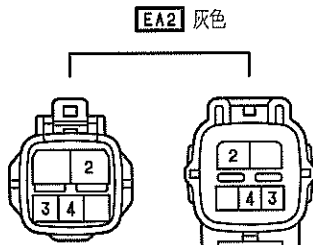
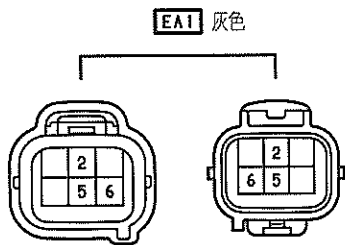
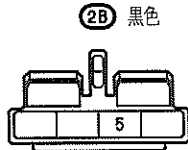
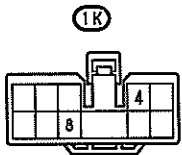
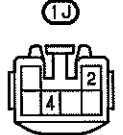
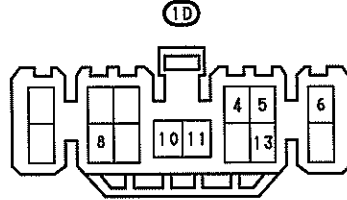
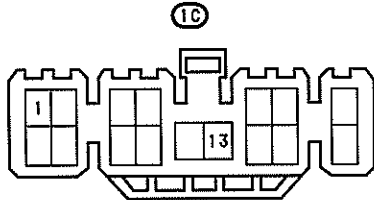
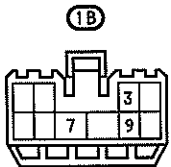
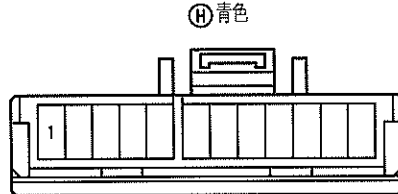
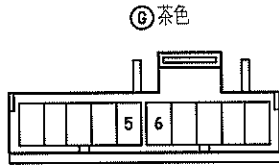
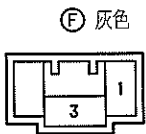
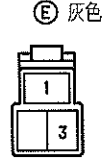
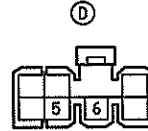
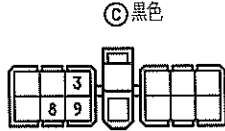
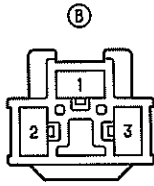
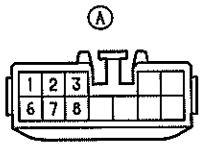

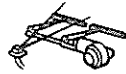

- △ 1G-FEグラウンディング
- 除く1G-FEグラウンディング

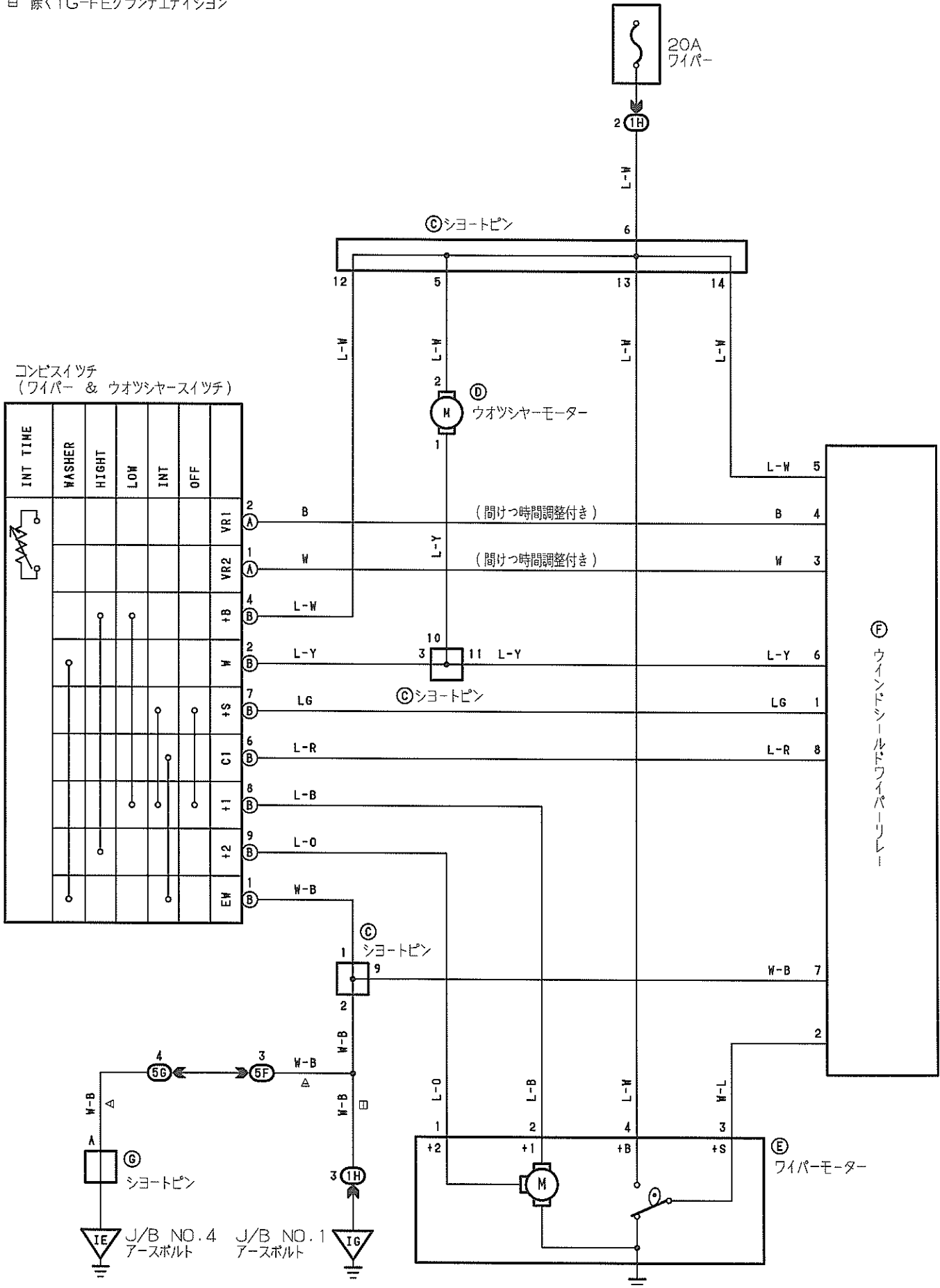

コンビスイッチ
(ワイパー & ウォツシャースイッチ)

INT TIME	WASHER	HIGHT	LOW	INT	OFF	
						VR1
						VR2
						+B
						W
						+S
						C1
						+1
						+2
						EW

⑥ ウィンドシールドワイパーリレー

⑤ ワイパーモーター

④ ウォツシャーマーター

20A
ワイパー

③ ショートピン

③ ショートピン

③ ショートピン

J/B NO.4
アースボルト

J/B NO.1
アースボルト

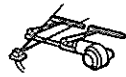

Ⓐ 黒色

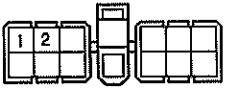

Ⓑ 黒色

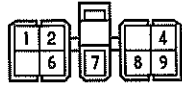

Ⓒ

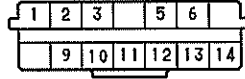

Ⓓ 黒色

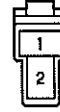

Ⓔ 黒色

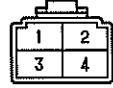

Ⓕ

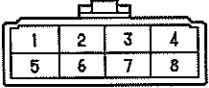

Ⓖ

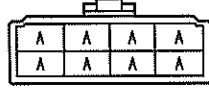

(J/B NO. 4)
(テレコ可)

⓫

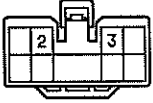

⓪

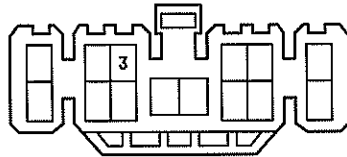

⓬

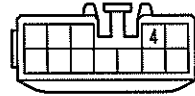

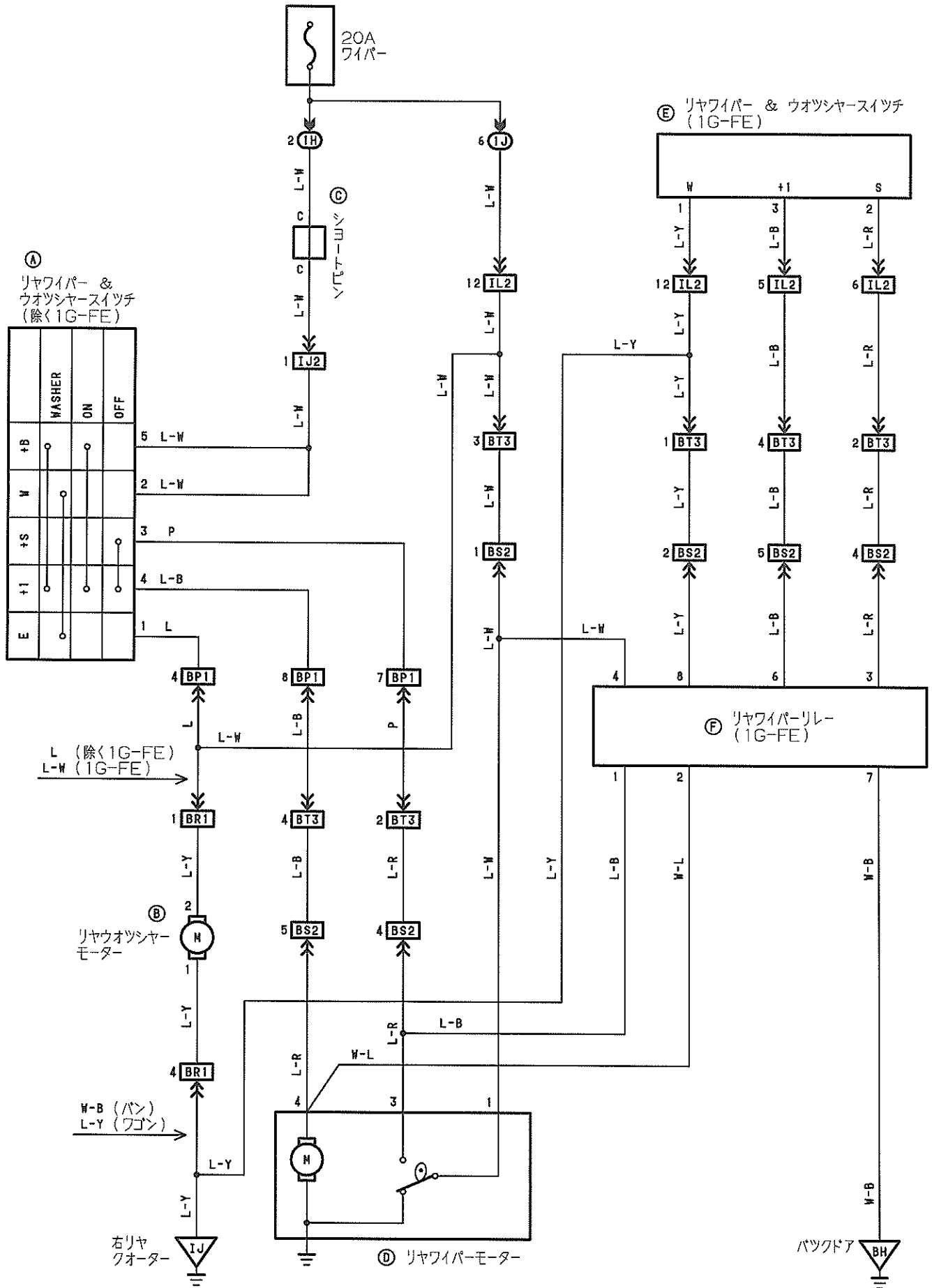

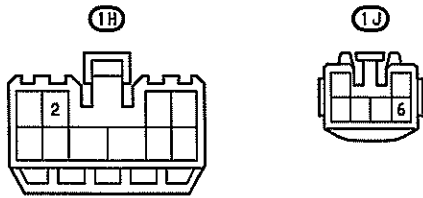
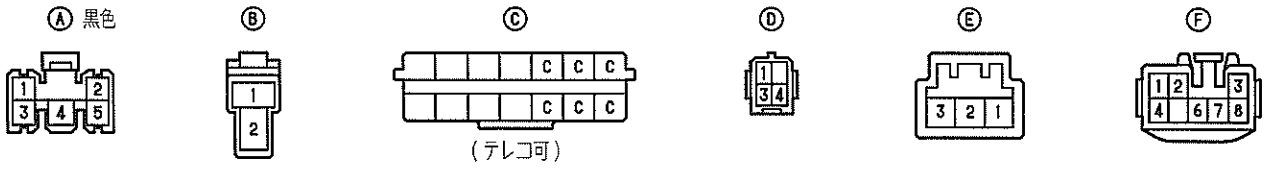

IJ2 IL1 濃灰色

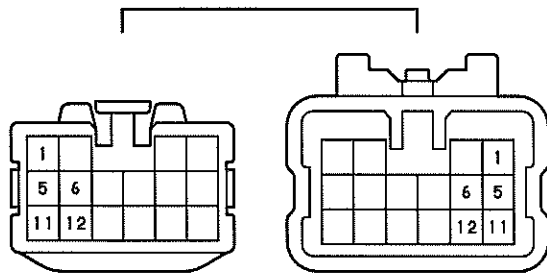

BP1

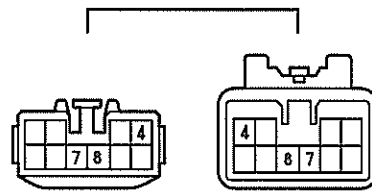

BR1 濃灰色

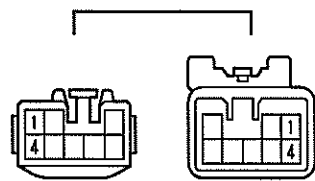

BS2

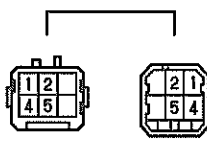

BT3

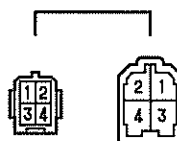

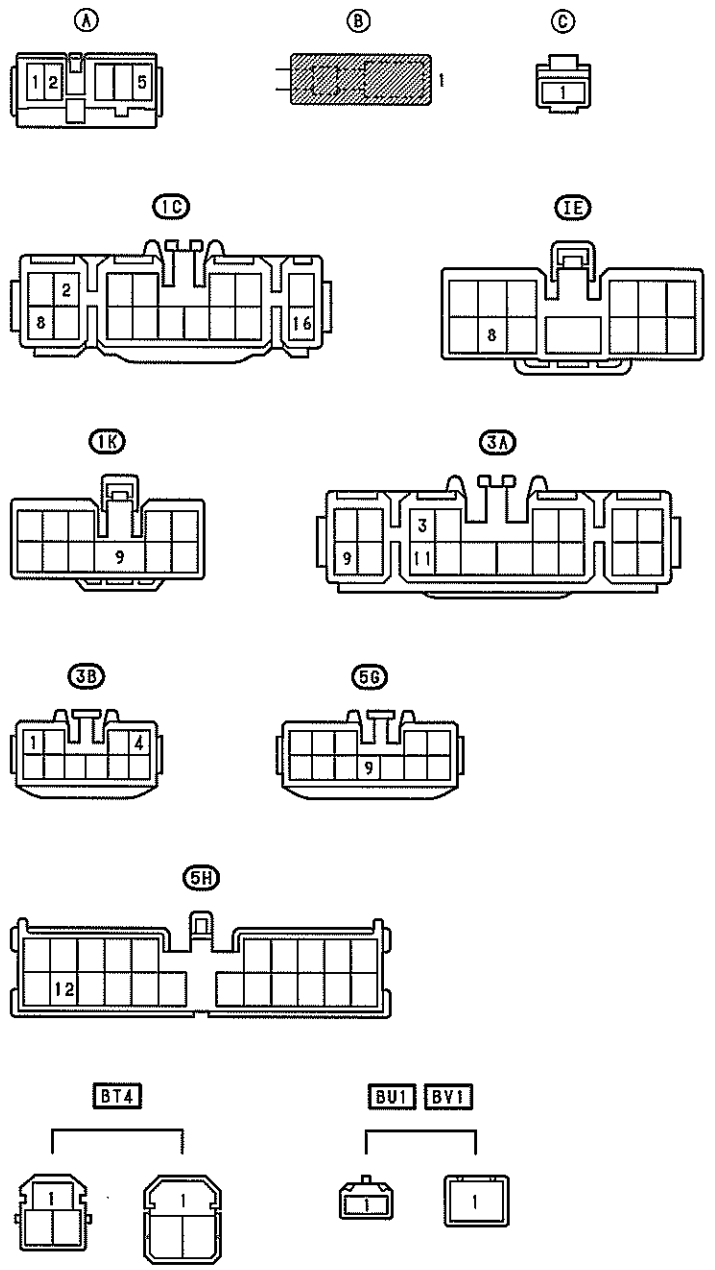
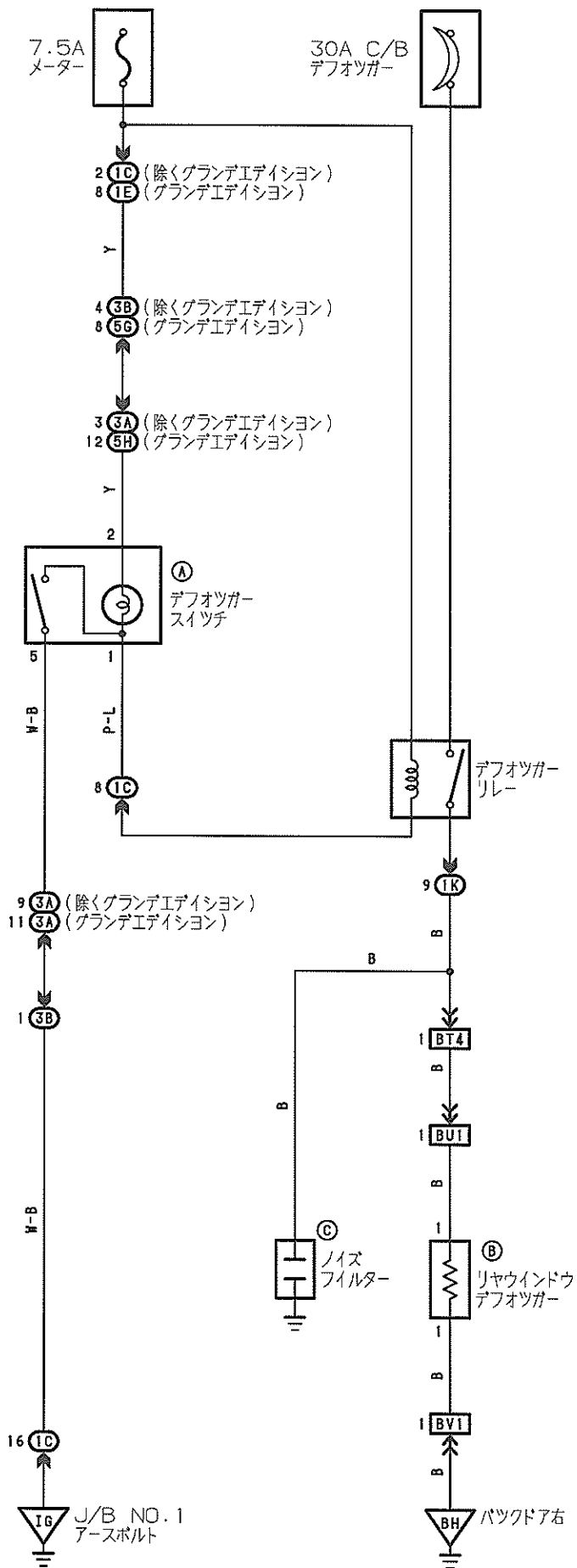

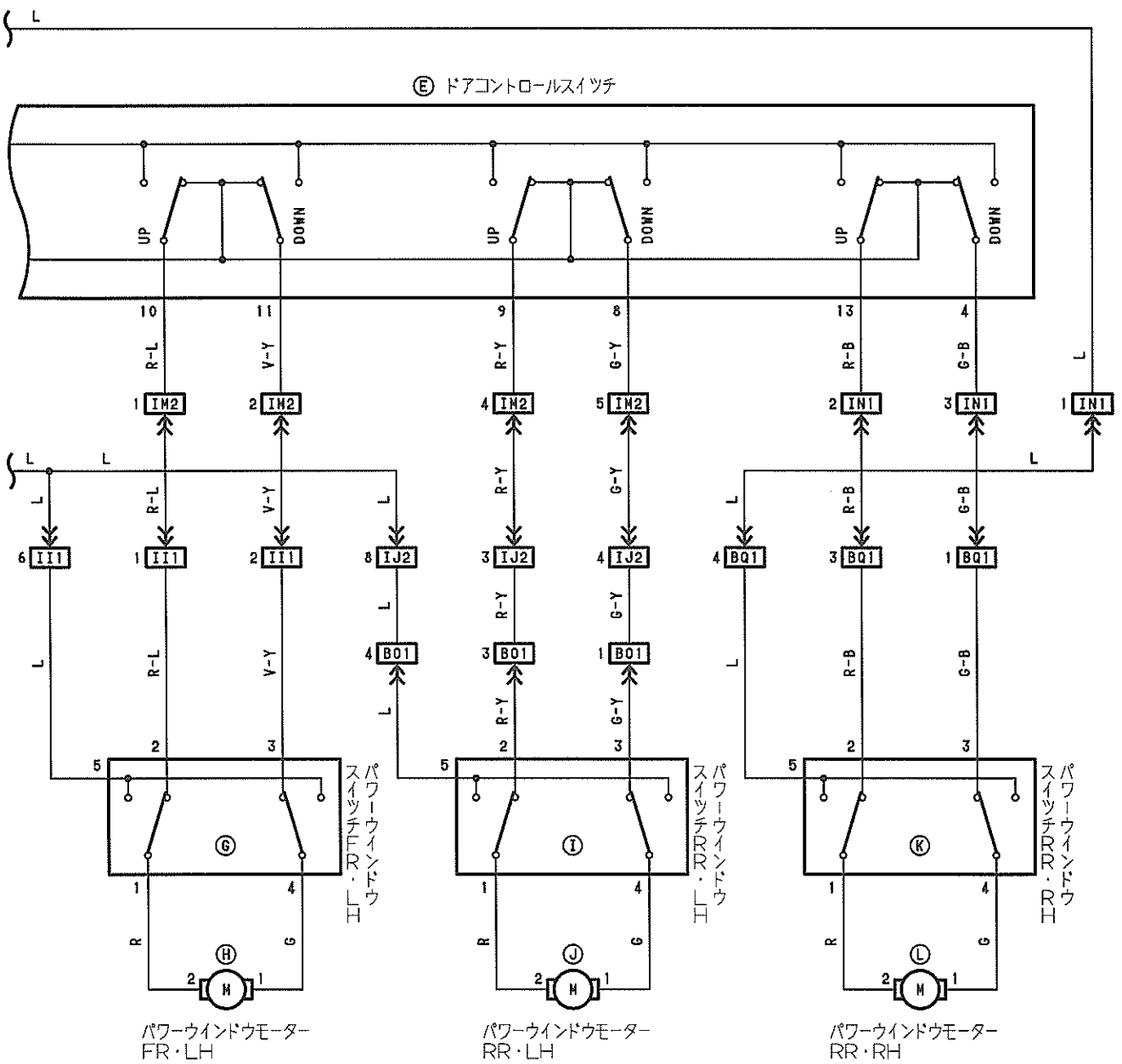

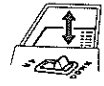

Ⓐ 黒色

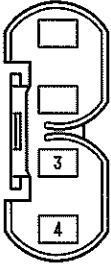

Ⓑ



Ⓒ

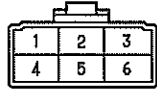

Ⓓ



Ⓔ

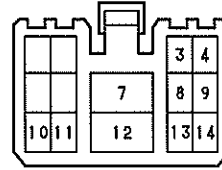

Ⓕ Ⓖ Ⓙ Ⓚ Ⓛ



Ⓖ Ⓚ Ⓛ



Ⓜ

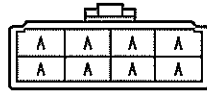

(J/B NO. 4)
(テレコ可)

ⓁⒸ

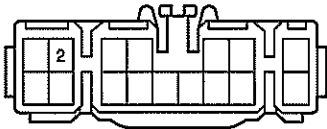

ⓁⒺ

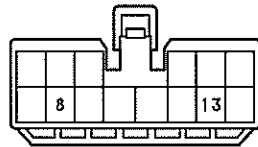

ⓁⒻ

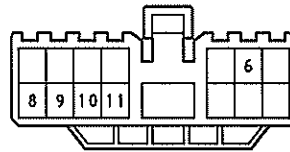

ⓁⓀ

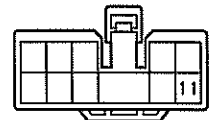

ⓁⒸ ⓁⒼ

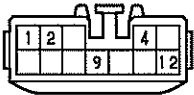

ⓁⒻ

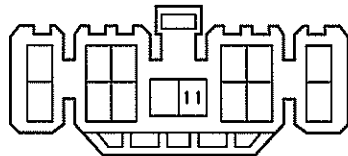

ⓁⒼ

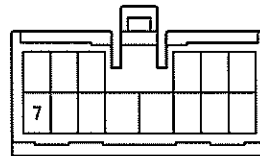

ⓁⒻ

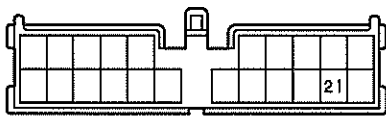

ⓁⒼ

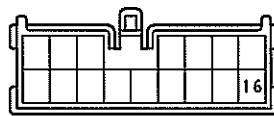



II1 青色

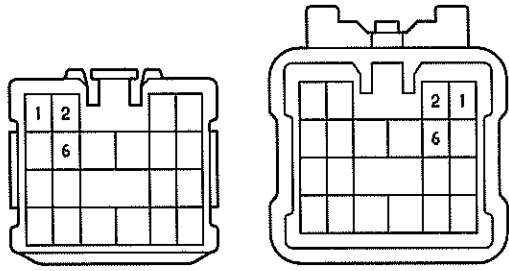

IJ2 濃灰色

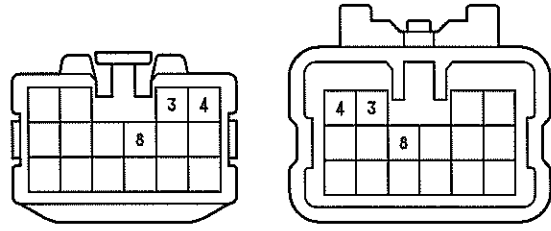

IW2 青色

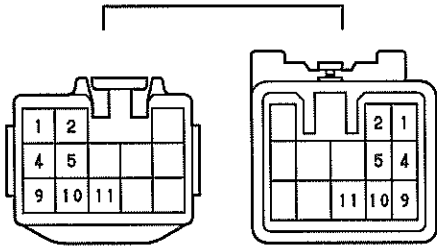

IN1

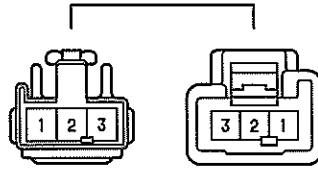

B01 **BQ1** 青色

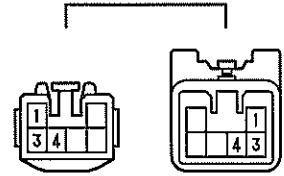

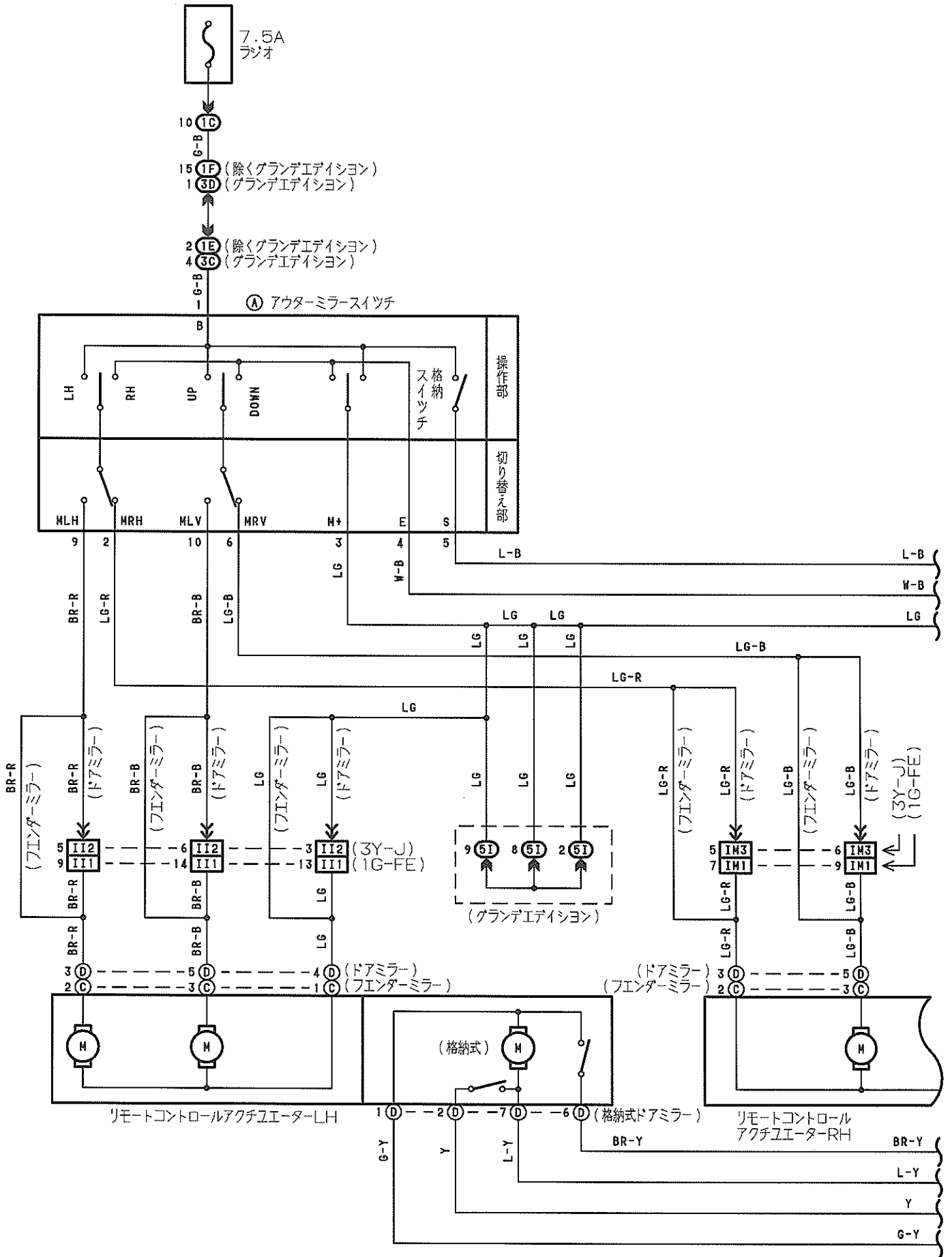

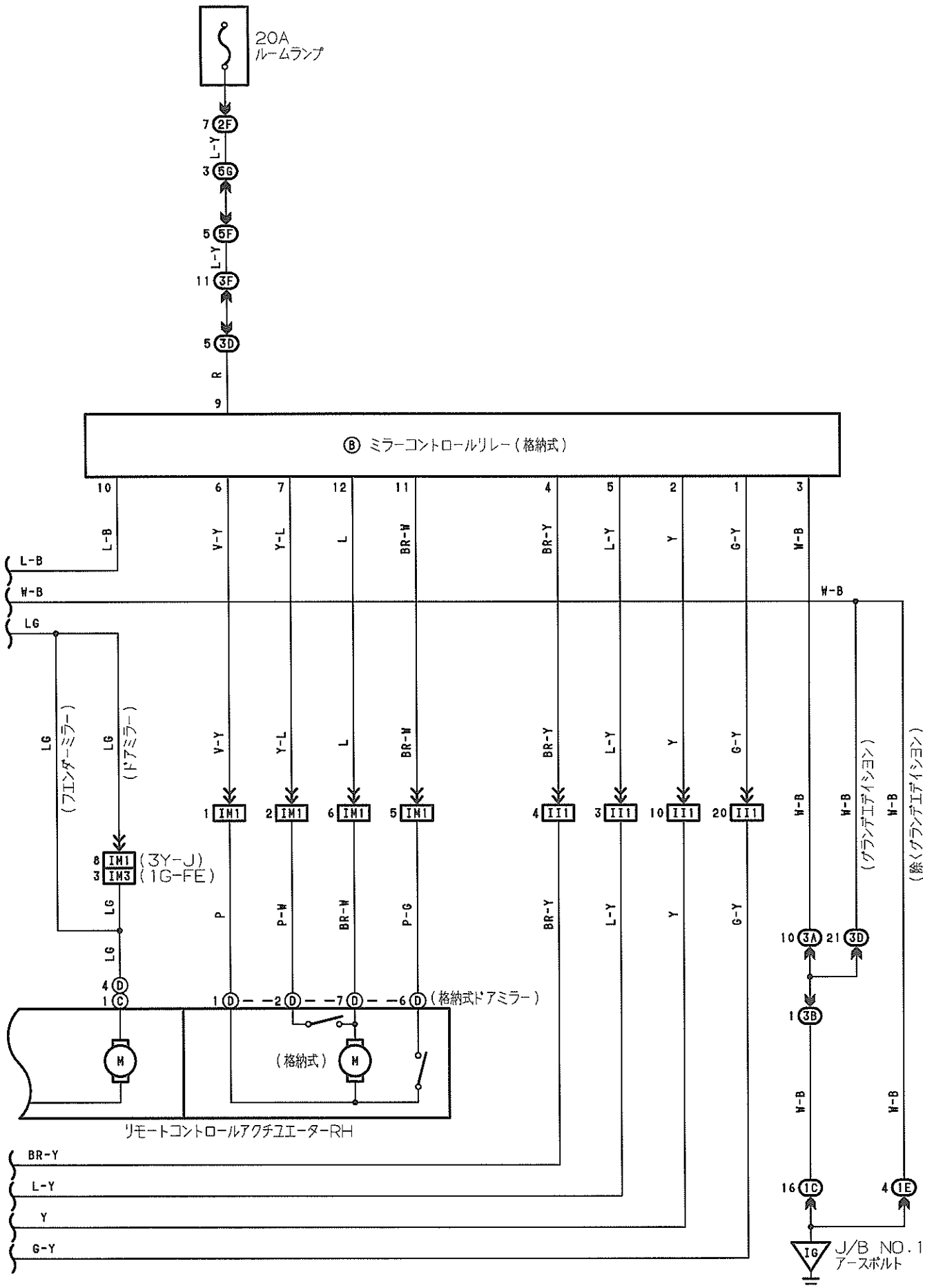
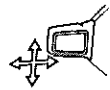

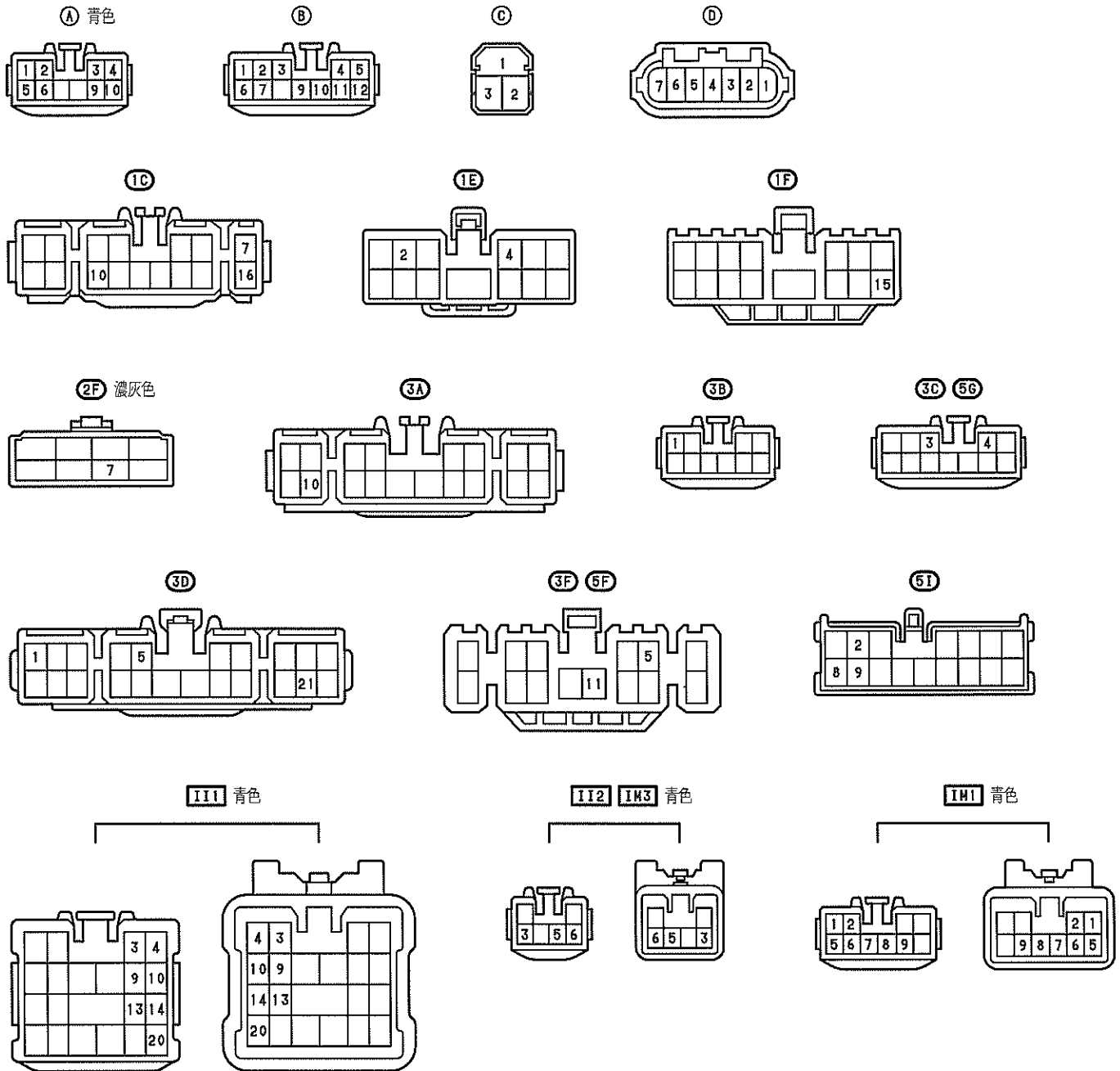

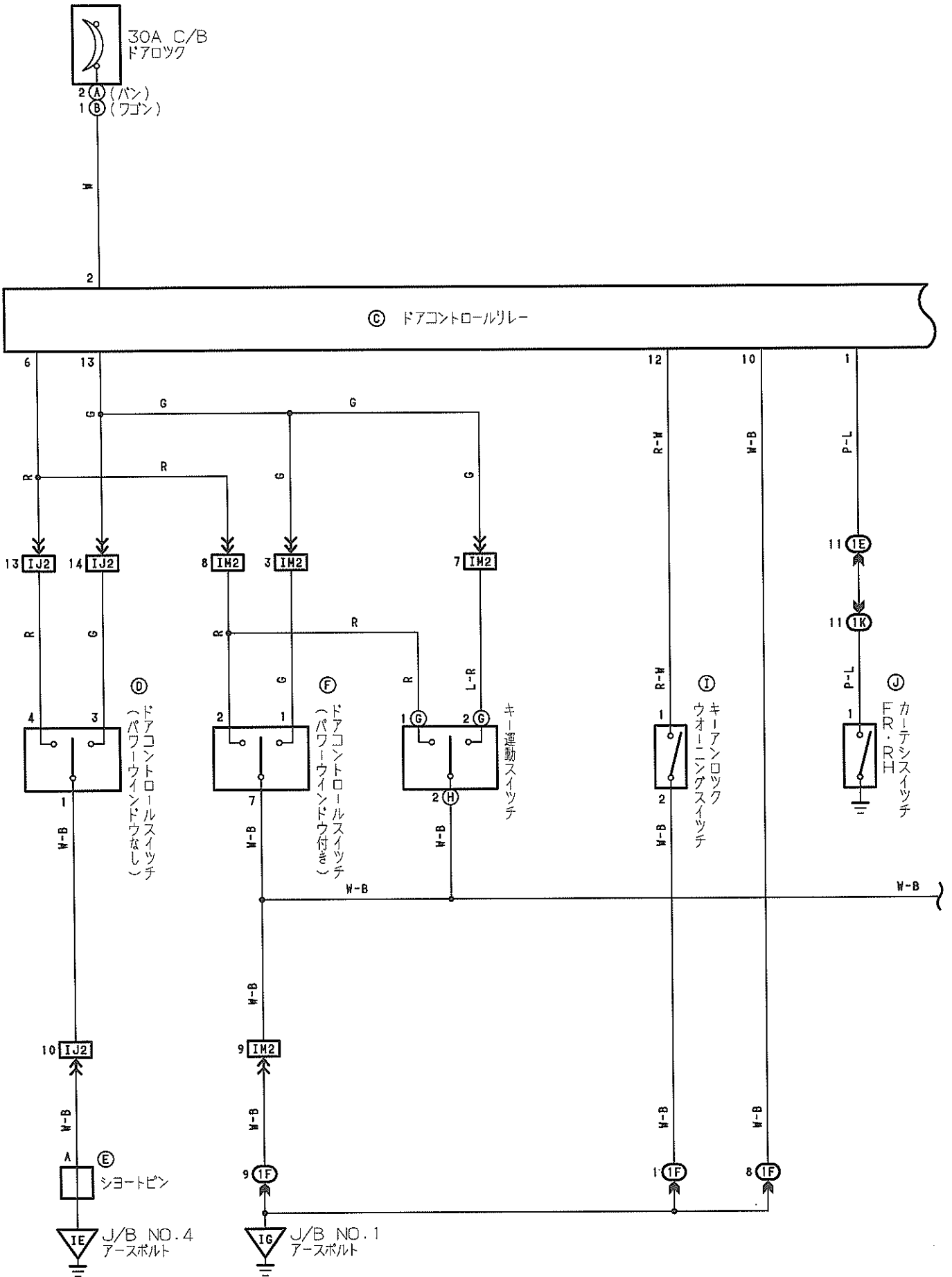

(2Y-J) ①

(1G-FE) ② 黒色

③

④

⑤

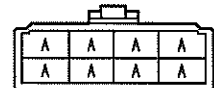
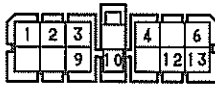
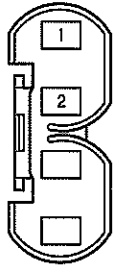
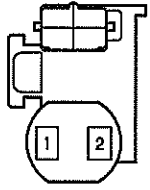

(J/B NO. 4)
(テレコ可)

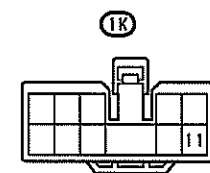
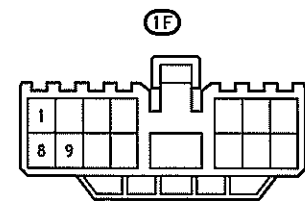
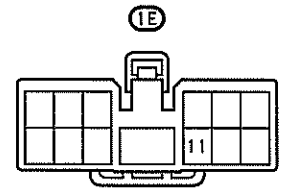
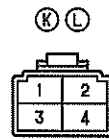
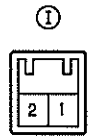
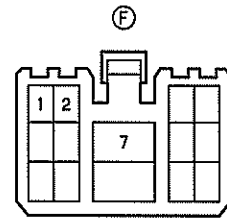
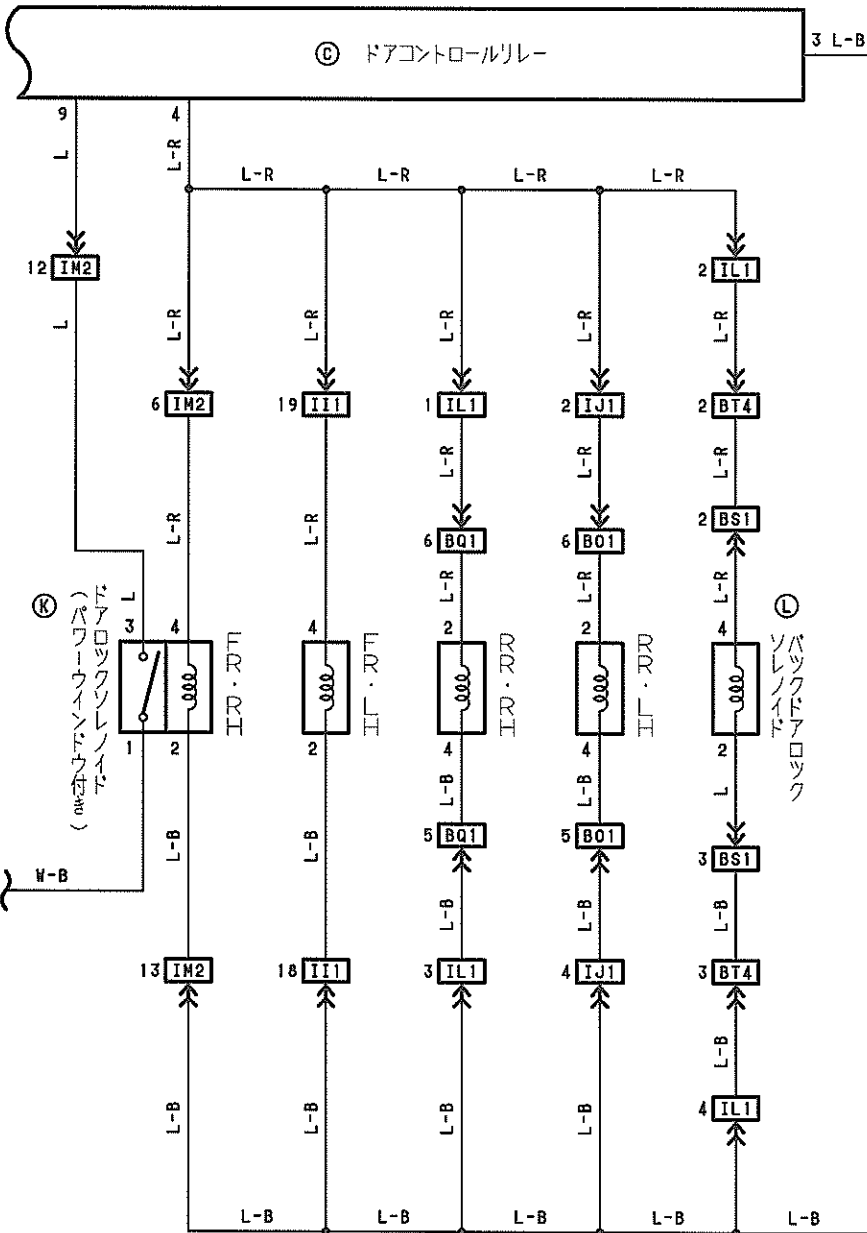



III 青色

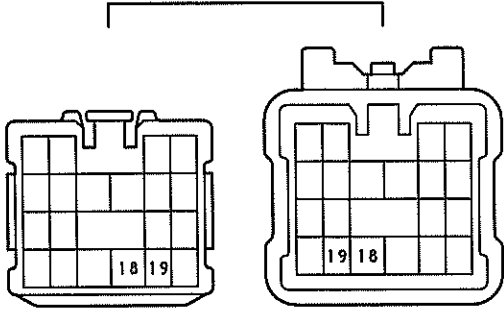

IJI ILI

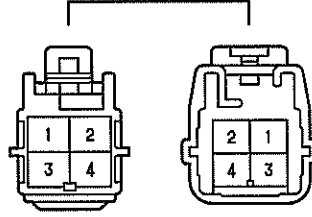

IJ2 灰色

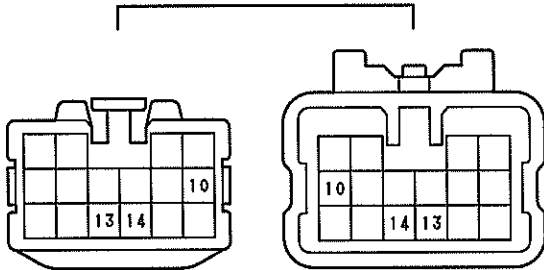

IN2 青色

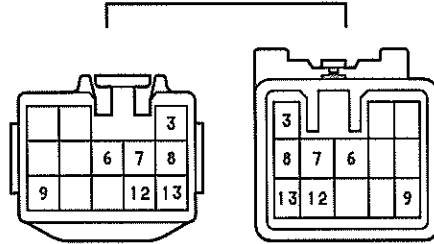

B01 BQ1 青色

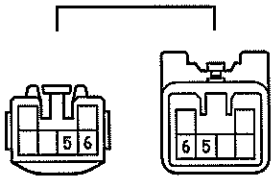

BS1 BT4

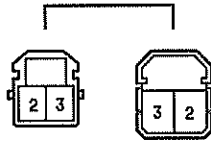

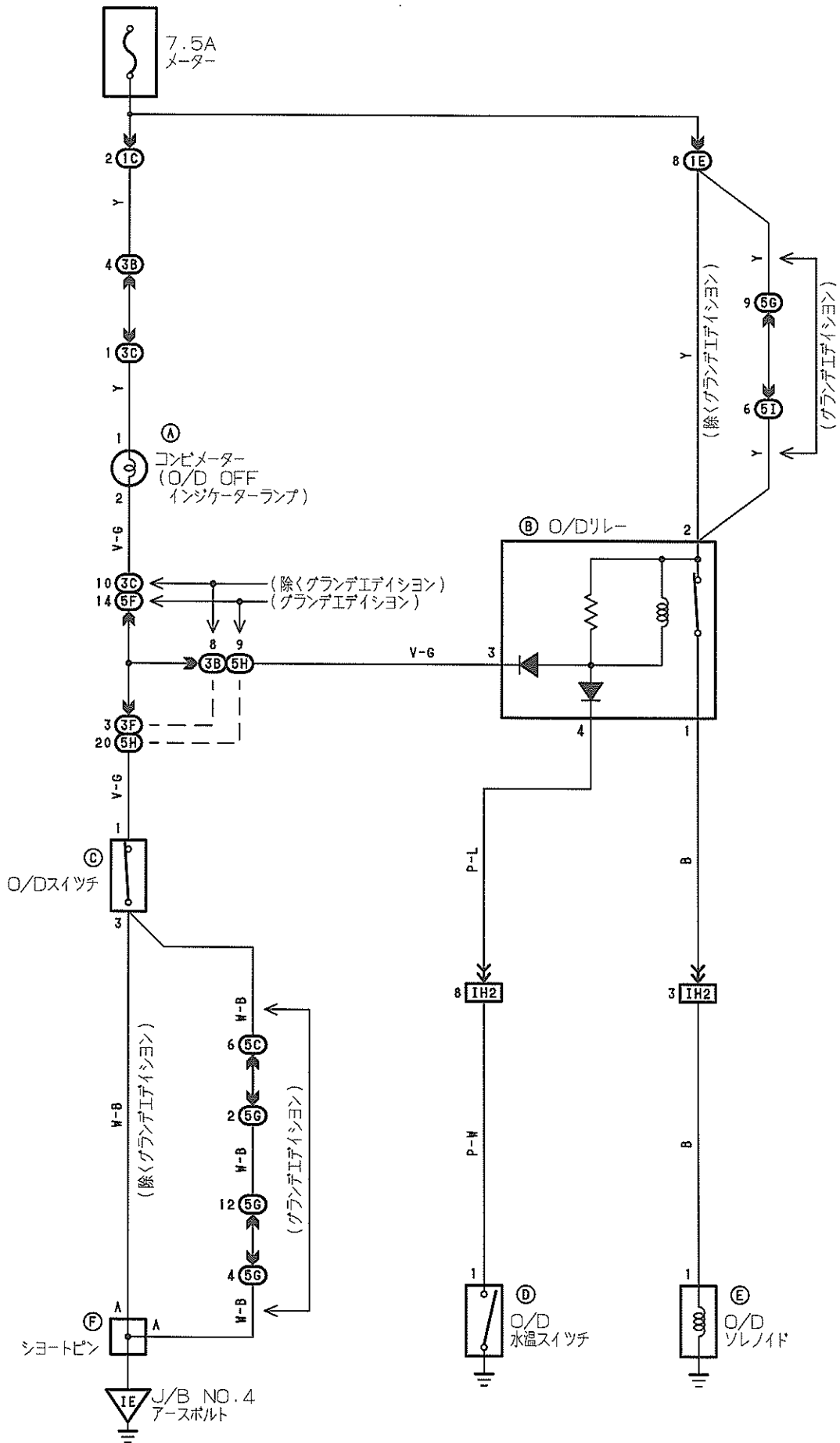

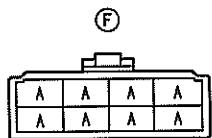
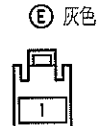
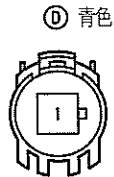
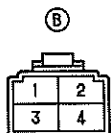
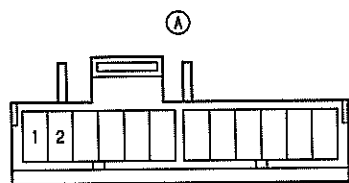

(J/B NO.4)
(テレコ可)

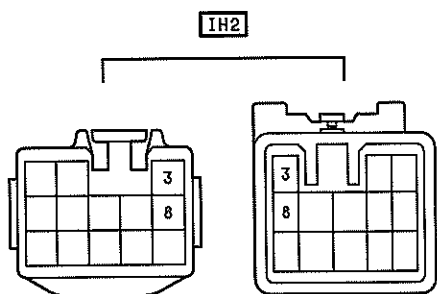
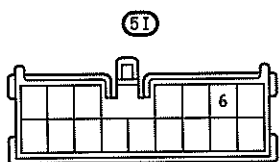
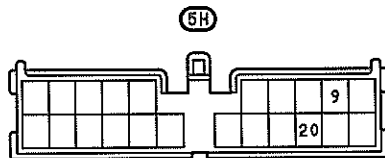
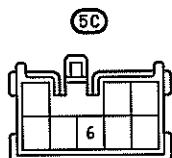
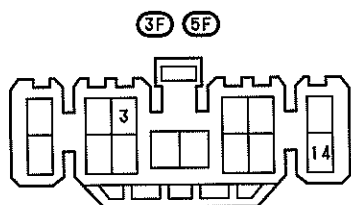
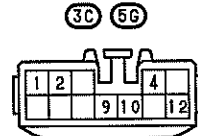
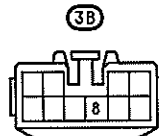
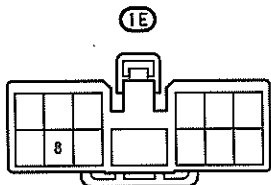
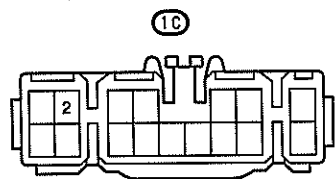

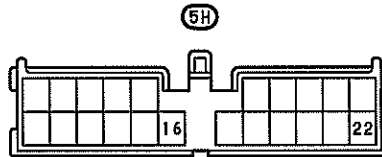
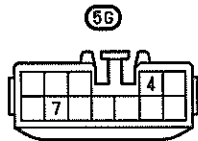
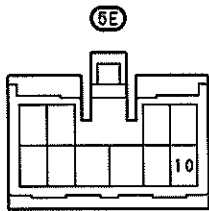
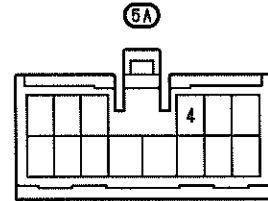
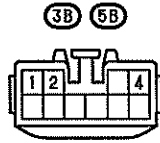
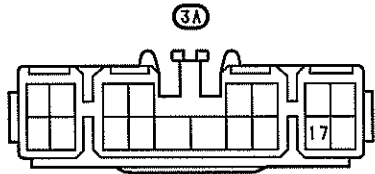
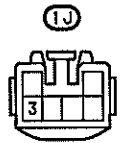
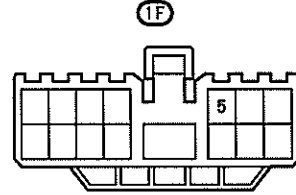
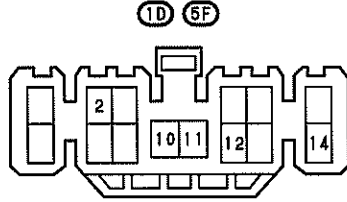
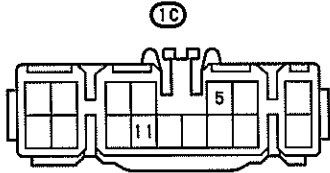
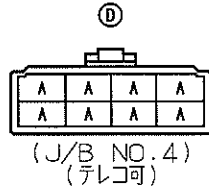
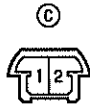
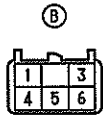
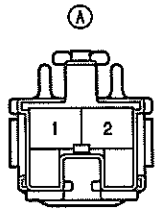

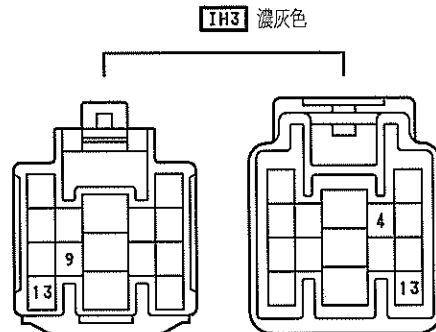
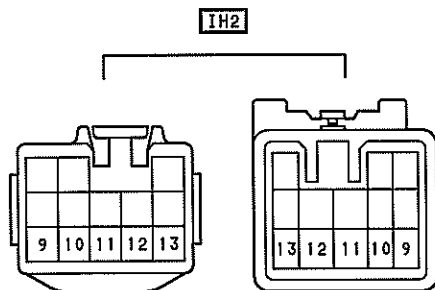
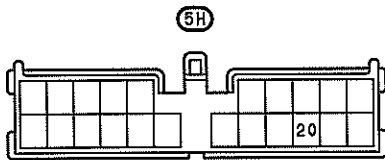
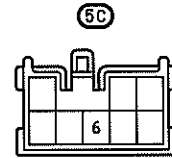
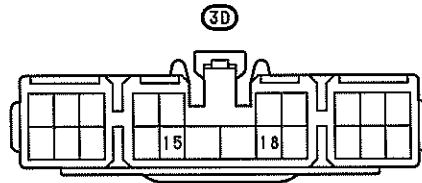
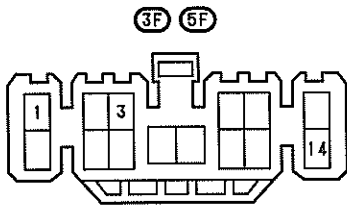
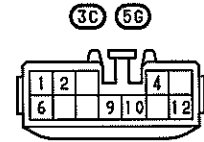
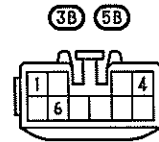
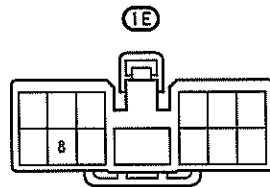
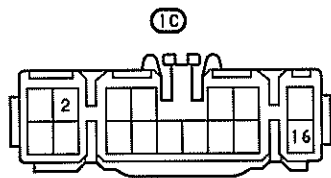
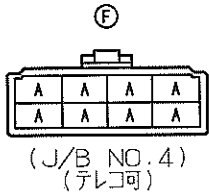
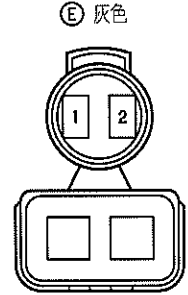
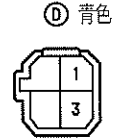
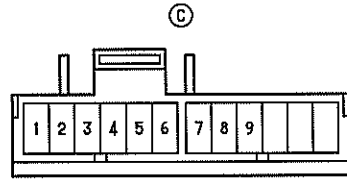
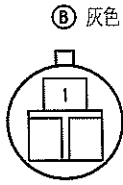

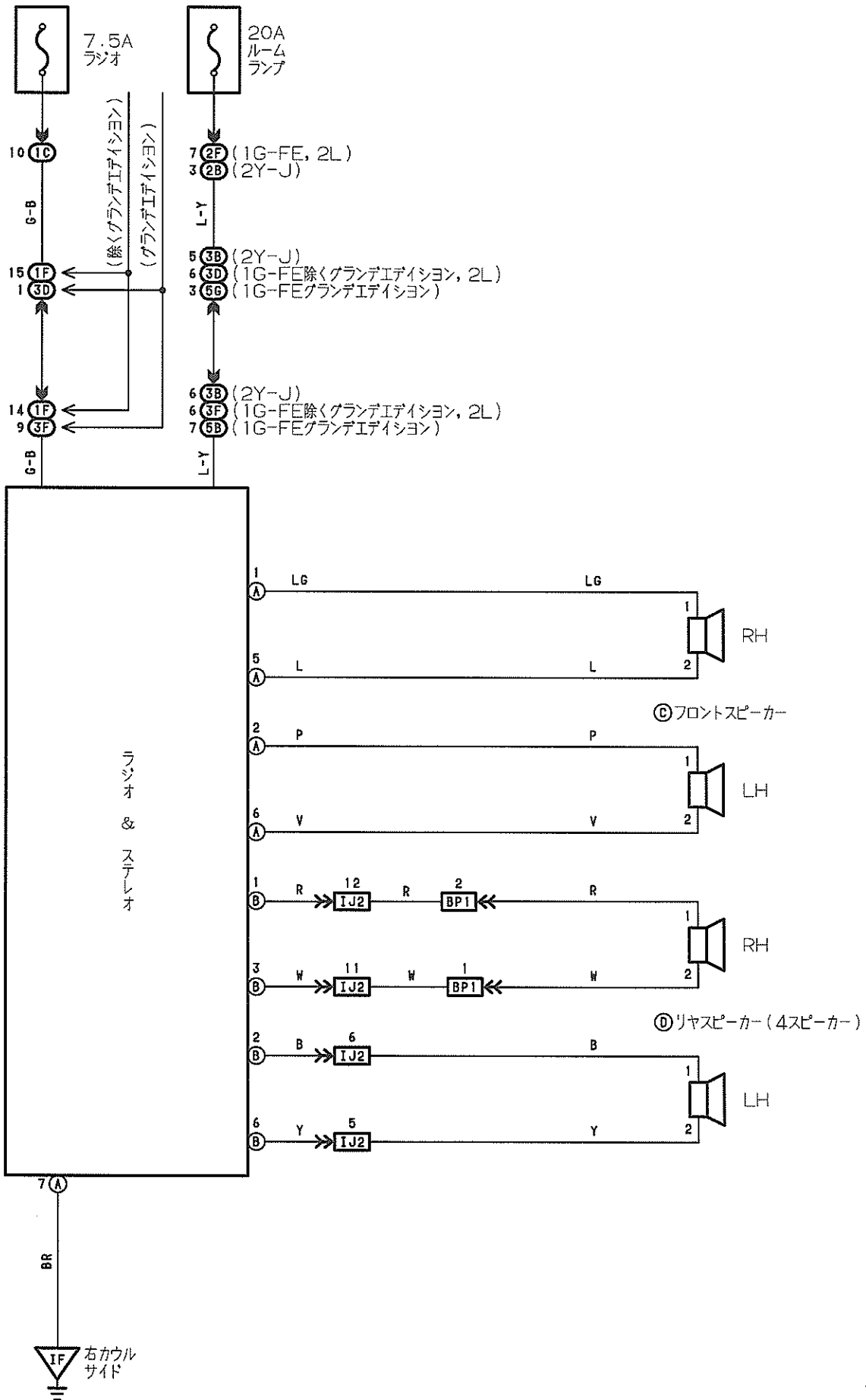

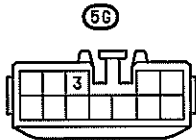
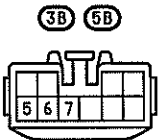
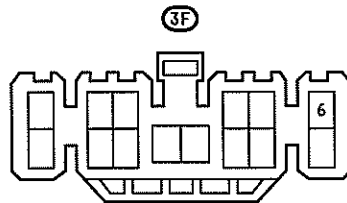
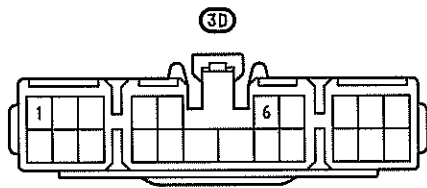
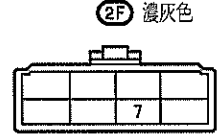
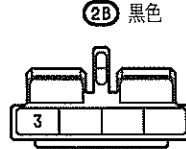
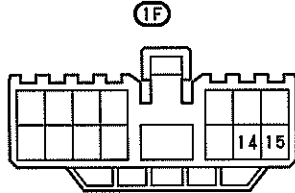
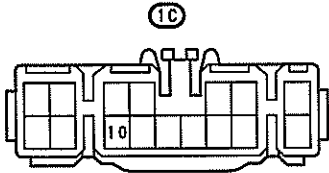
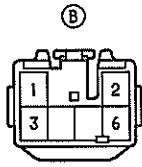
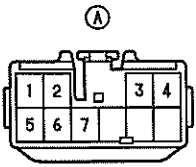

1J2 濃灰色

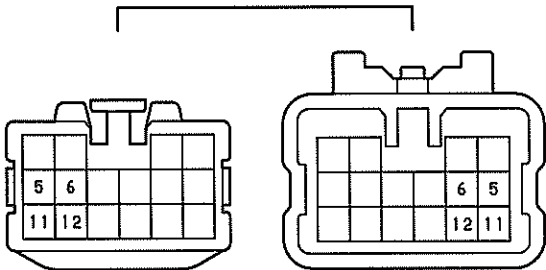

BP1 濃灰色

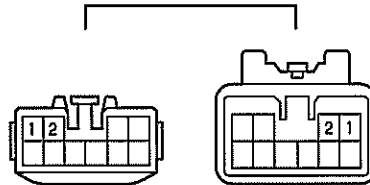



アンテナモーター

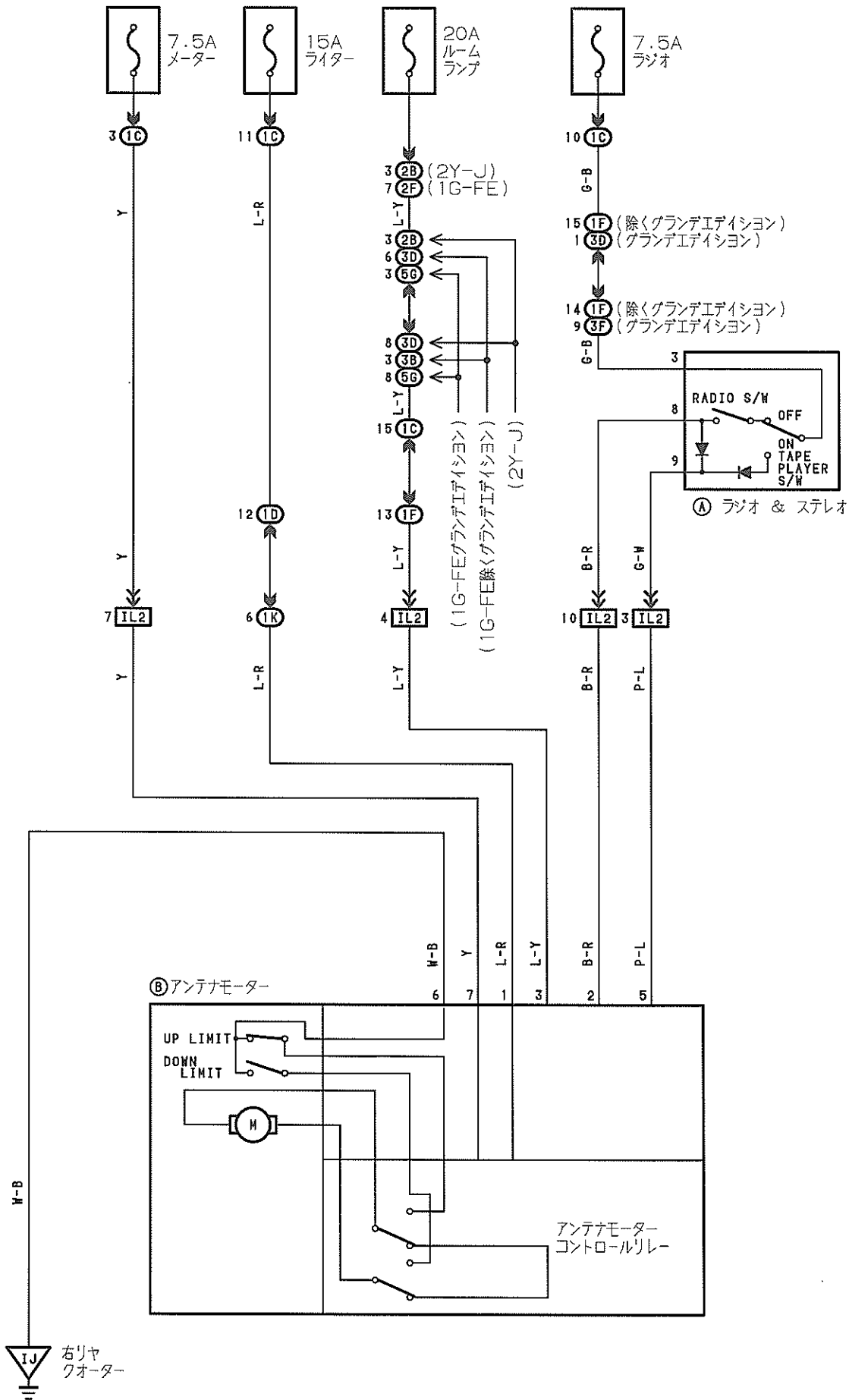

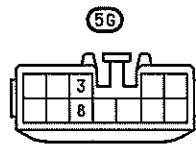
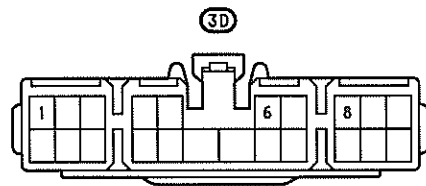
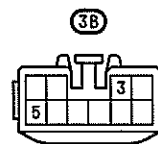
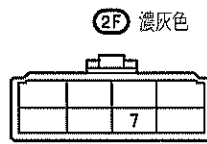
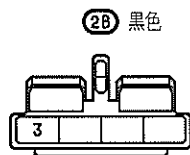
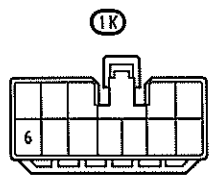
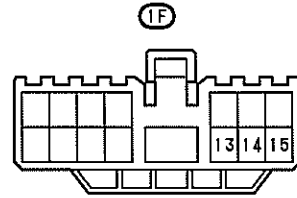
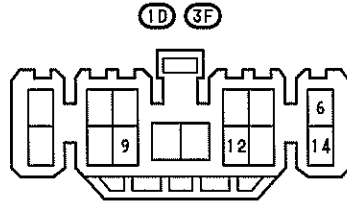
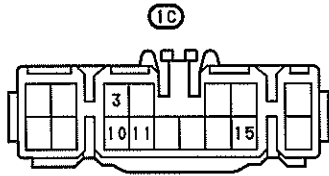
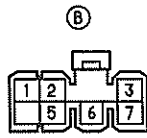
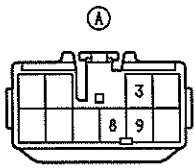

1L2 濃灰色

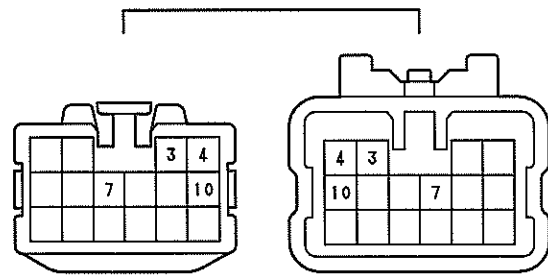



コンビネーションメーター

- ◇ 1G-FE除くグラウンドエディション, 2L
- 除くグラウンドエディション
- グラウンドエディション

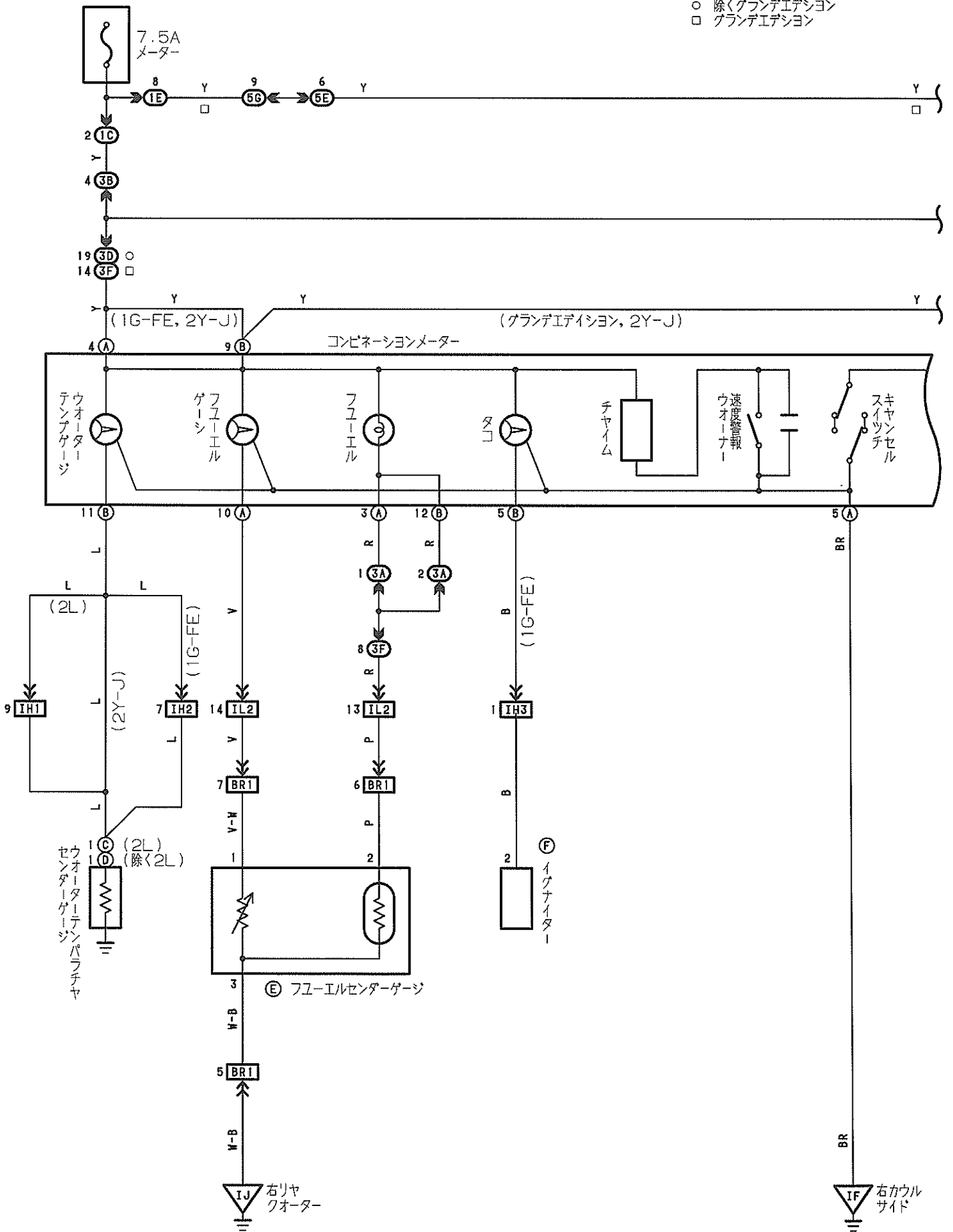

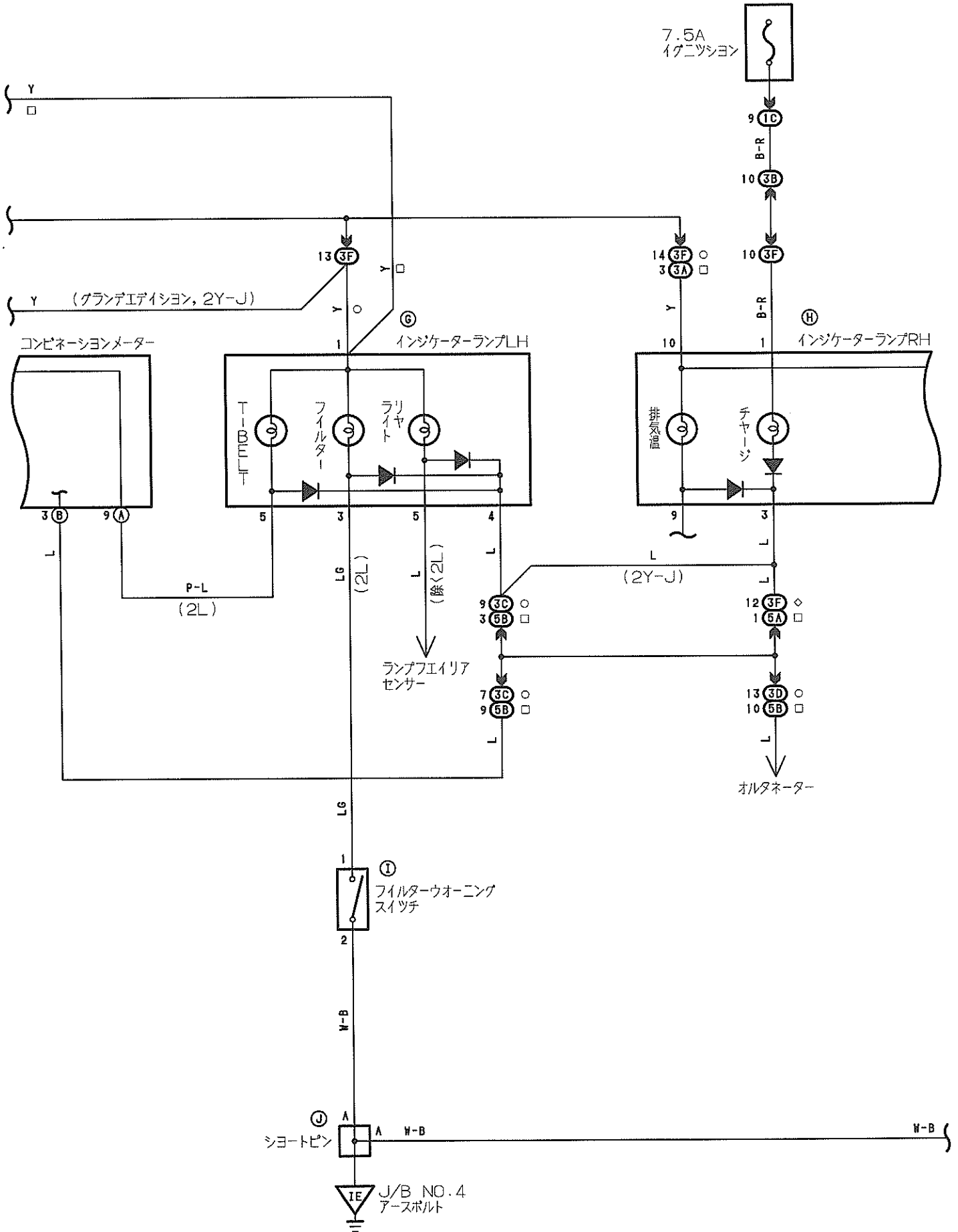

○ 除くグラウンドエディション
 □ グラウンドエディション

④ インジケータランプRH

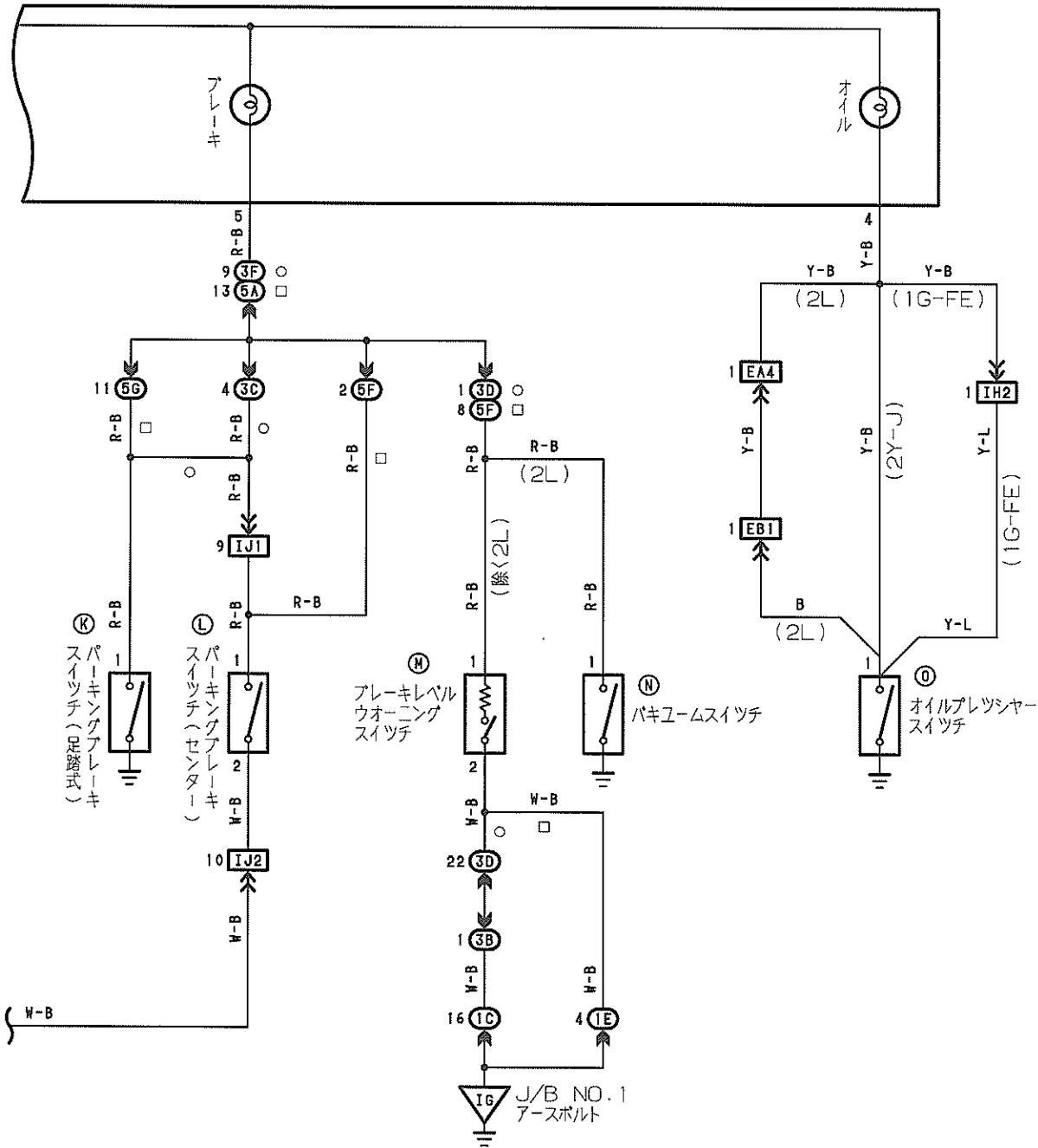

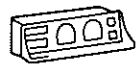

Ⓐ 茶色

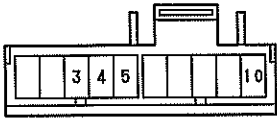

Ⓑ 青色

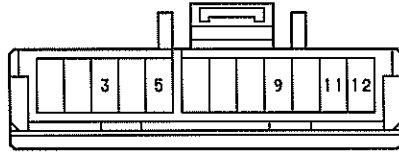

Ⓒ 茶色



Ⓓ 灰色



Ⓔ



Ⓕ 濃灰色

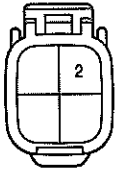

Ⓖ

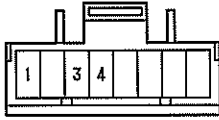

Ⓗ 灰色

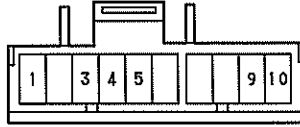

Ⓘ 灰色



Ⓙ

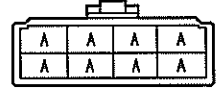

(J/B NO.4)
(テレコ可)

Ⓚ



Ⓛ



Ⓝ 灰色

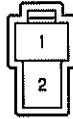

Ⓝ



ⓓ 黒色



1Ⓒ

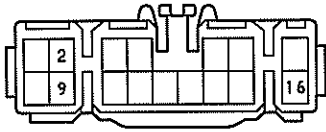

1Ⓔ

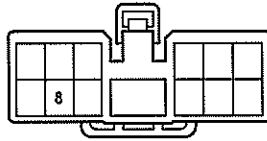

3Ⓐ

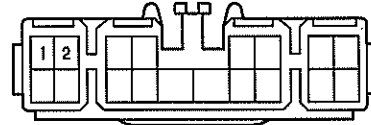

3Ⓑ 5Ⓑ

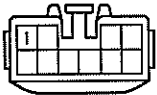

3Ⓒ 5Ⓑ



3Ⓓ

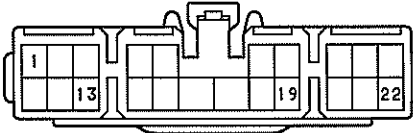

3Ⓕ 5Ⓕ

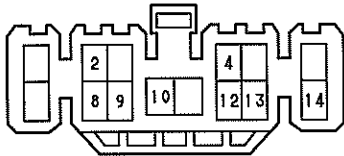

5Ⓐ

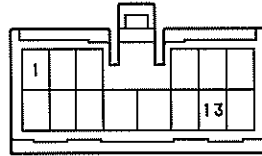

5Ⓔ

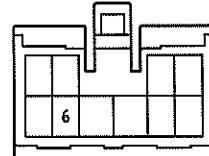

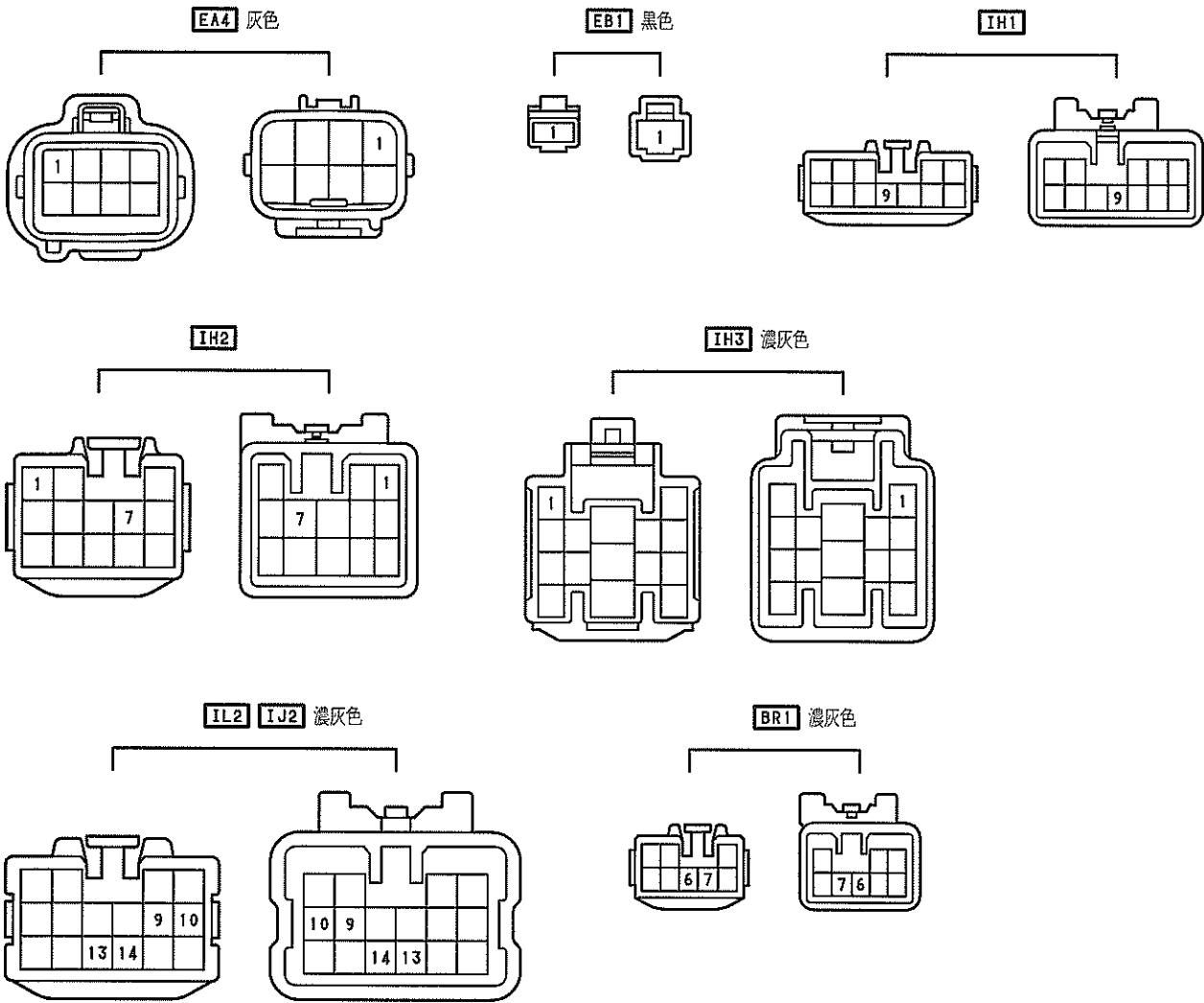

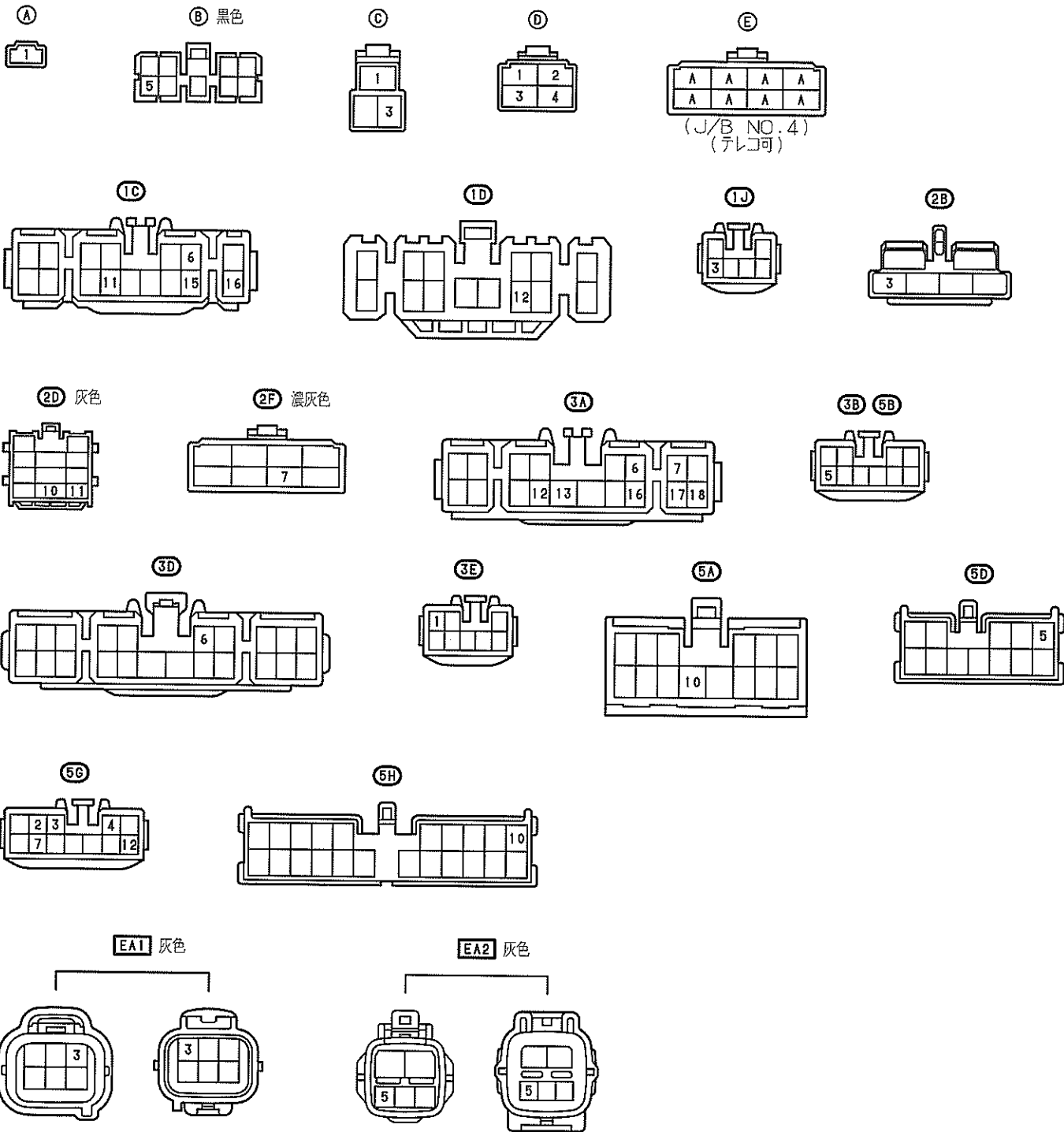

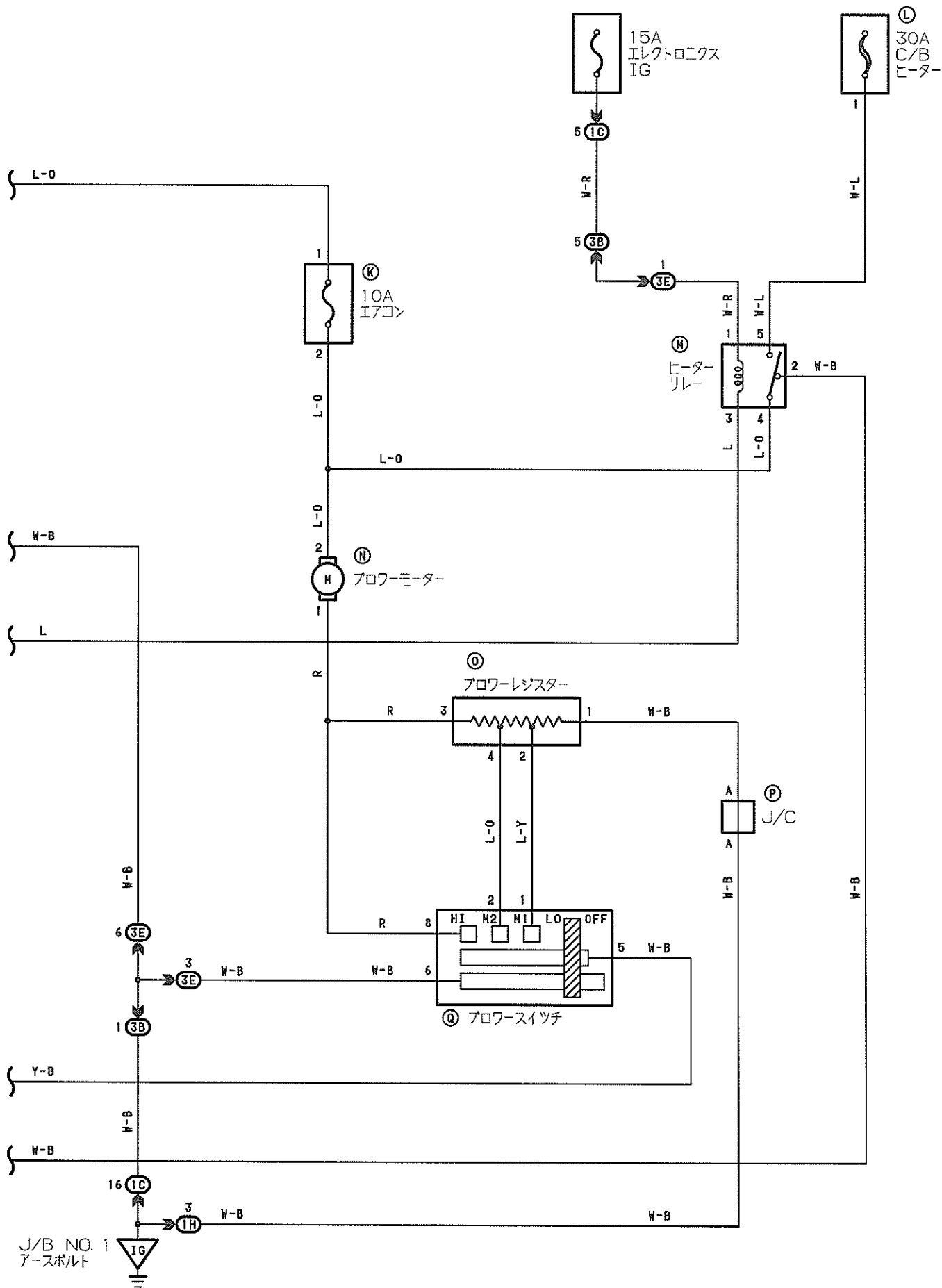



EA2 灰色

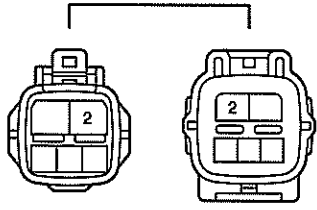

EA8 灰色

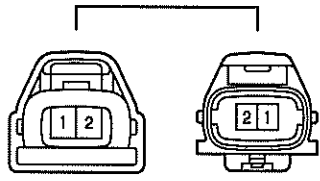

ED1 EW1 灰色

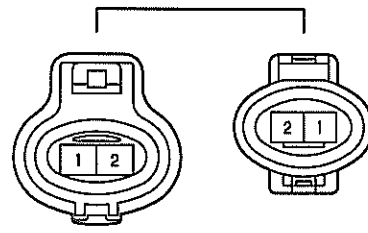



オートエアコンデyshoナー

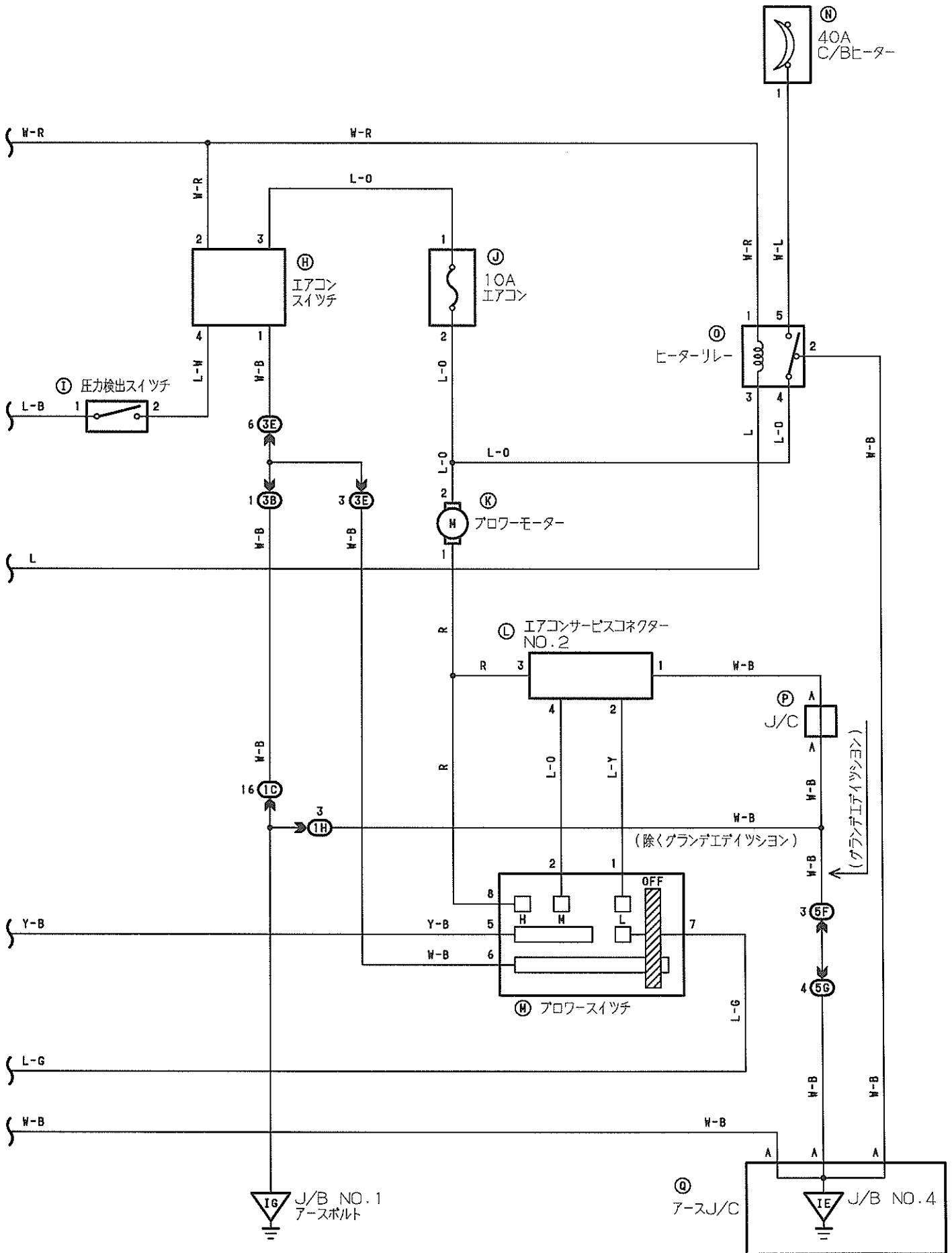

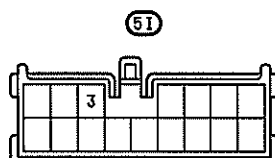
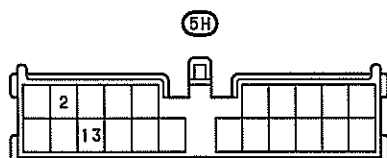
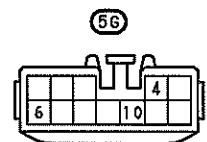
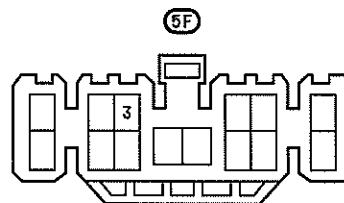
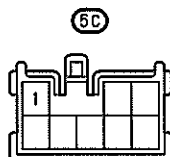
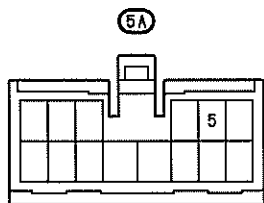
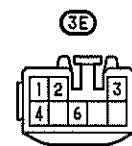
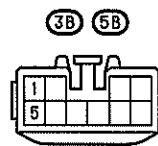
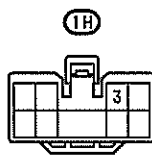
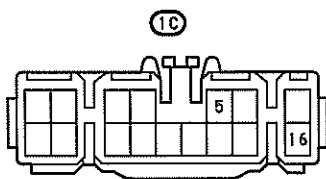
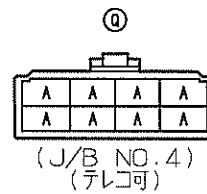
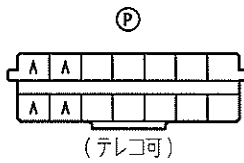
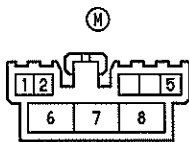
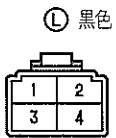
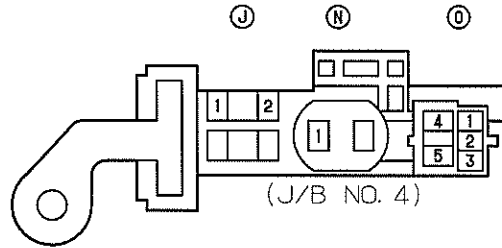
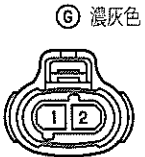
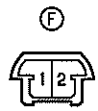
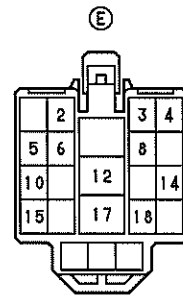
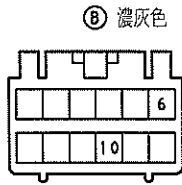
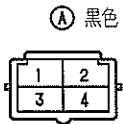

EA5 灰色

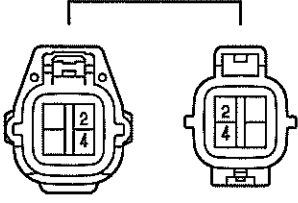

EA6 灰色

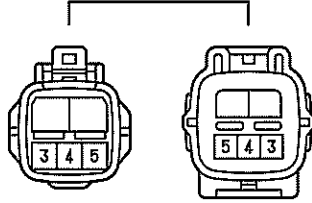

IH3 濃灰色

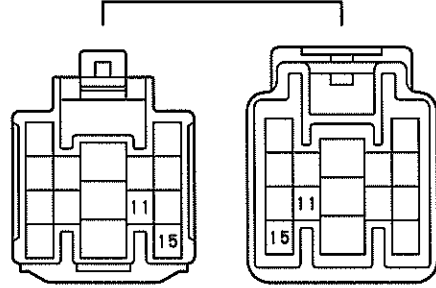

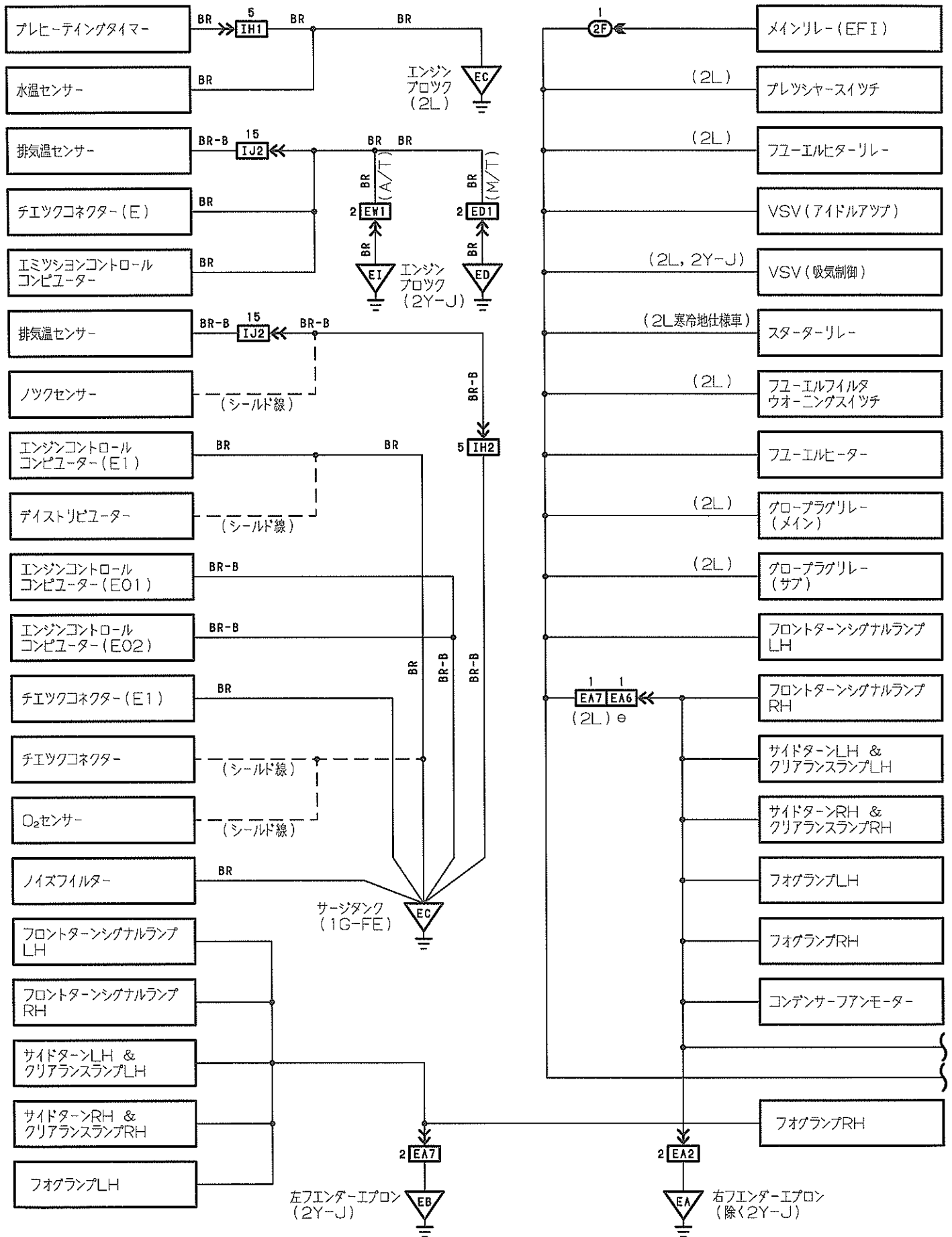

アースポイント

- △ 1G-FEグラウンドエディション ○ 除く2Y-J
- ◇ 除く1G-FEグラウンドエディション ◇ 2Y-J
- ▲ 1G-FE除くグラウンドエディション ● 1G-FE

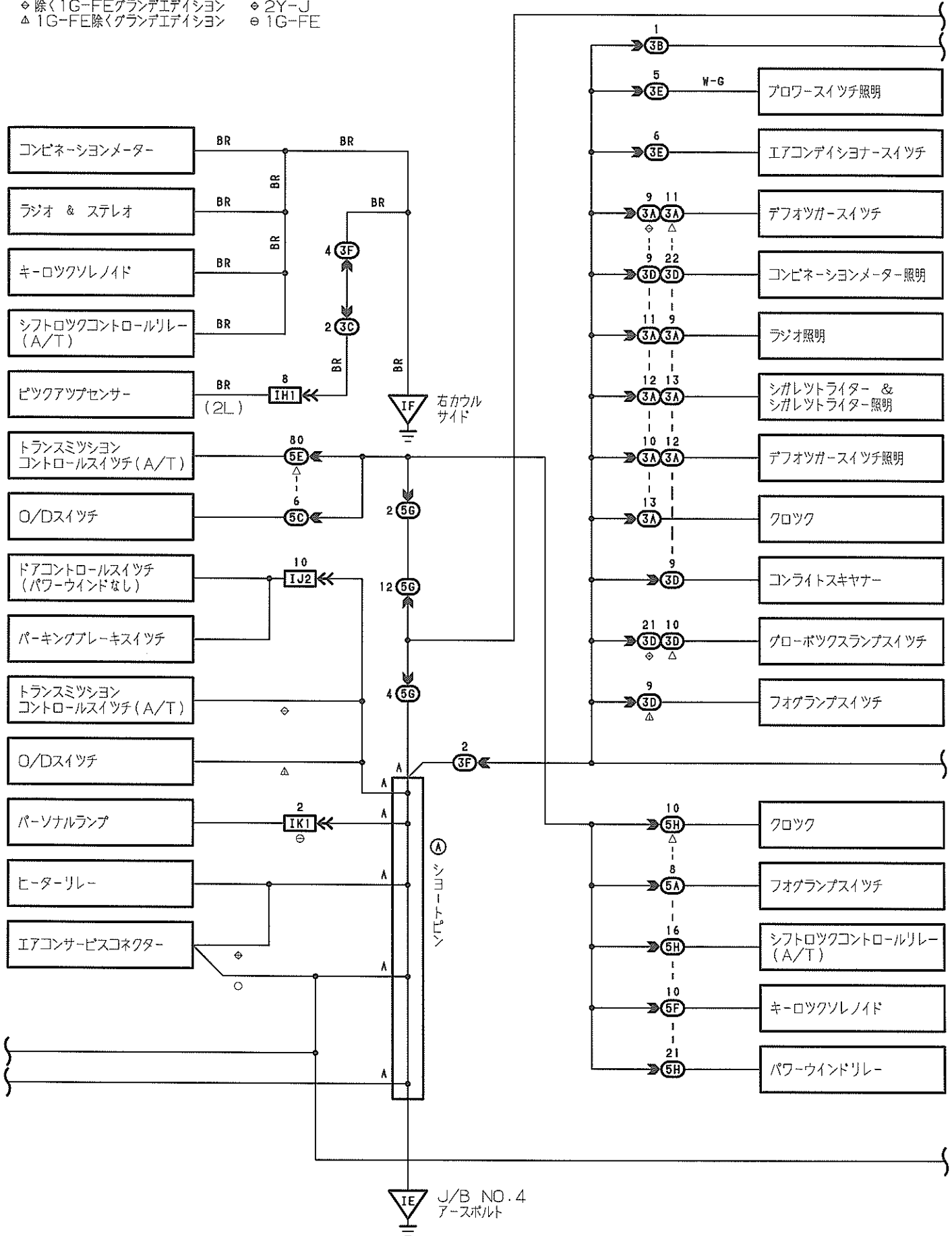

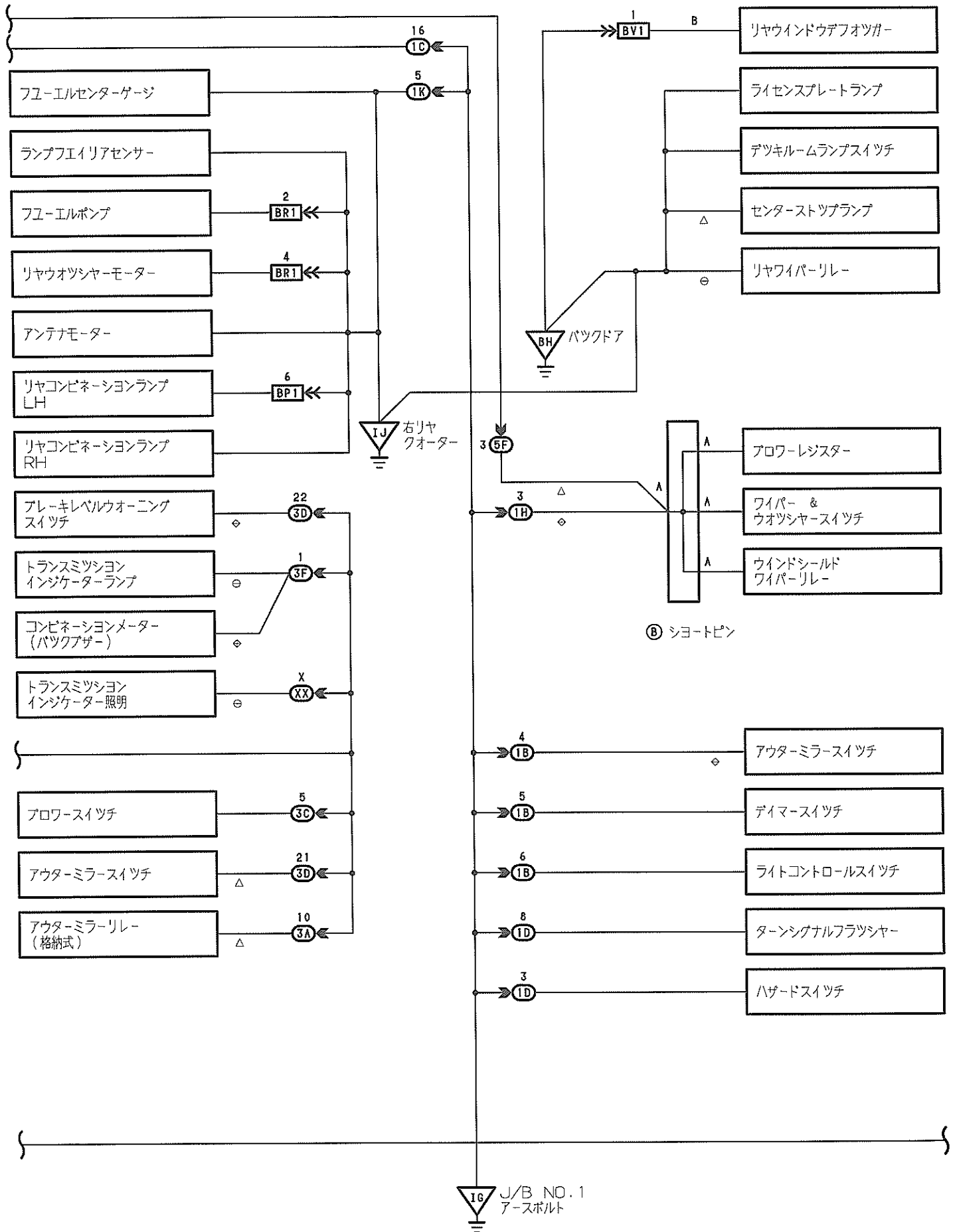

- △ 1G-FEグラウンドエディション
- ◇ 1G-FE除くグラウンドエディション
- △ 1G-FE除くグラウンドエディション
- ◇ 2Y-J
- ◇ 1G-FE, 1G-FEグラウンドエディション

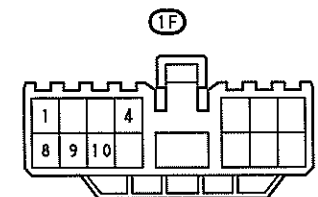
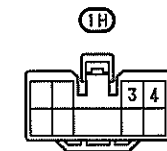
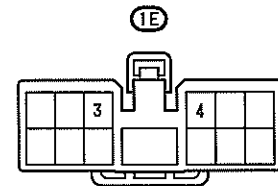
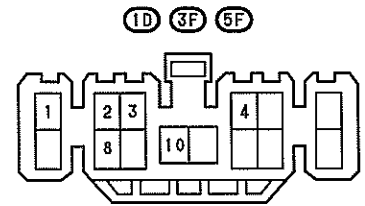
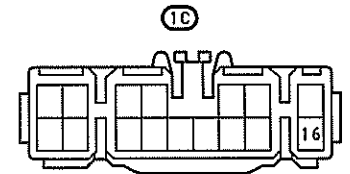
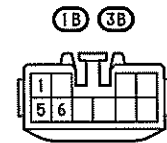
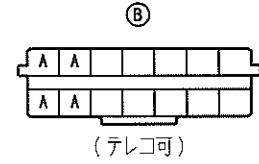
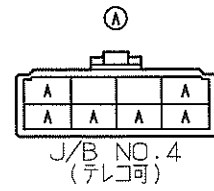
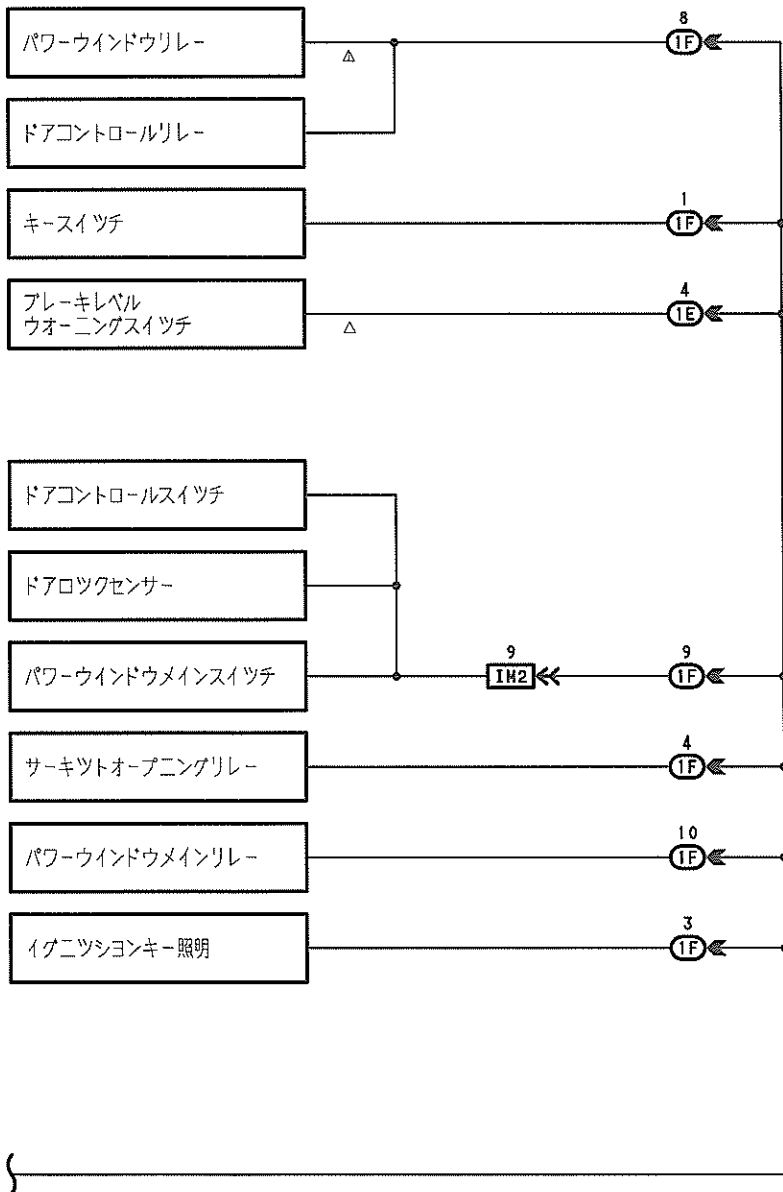

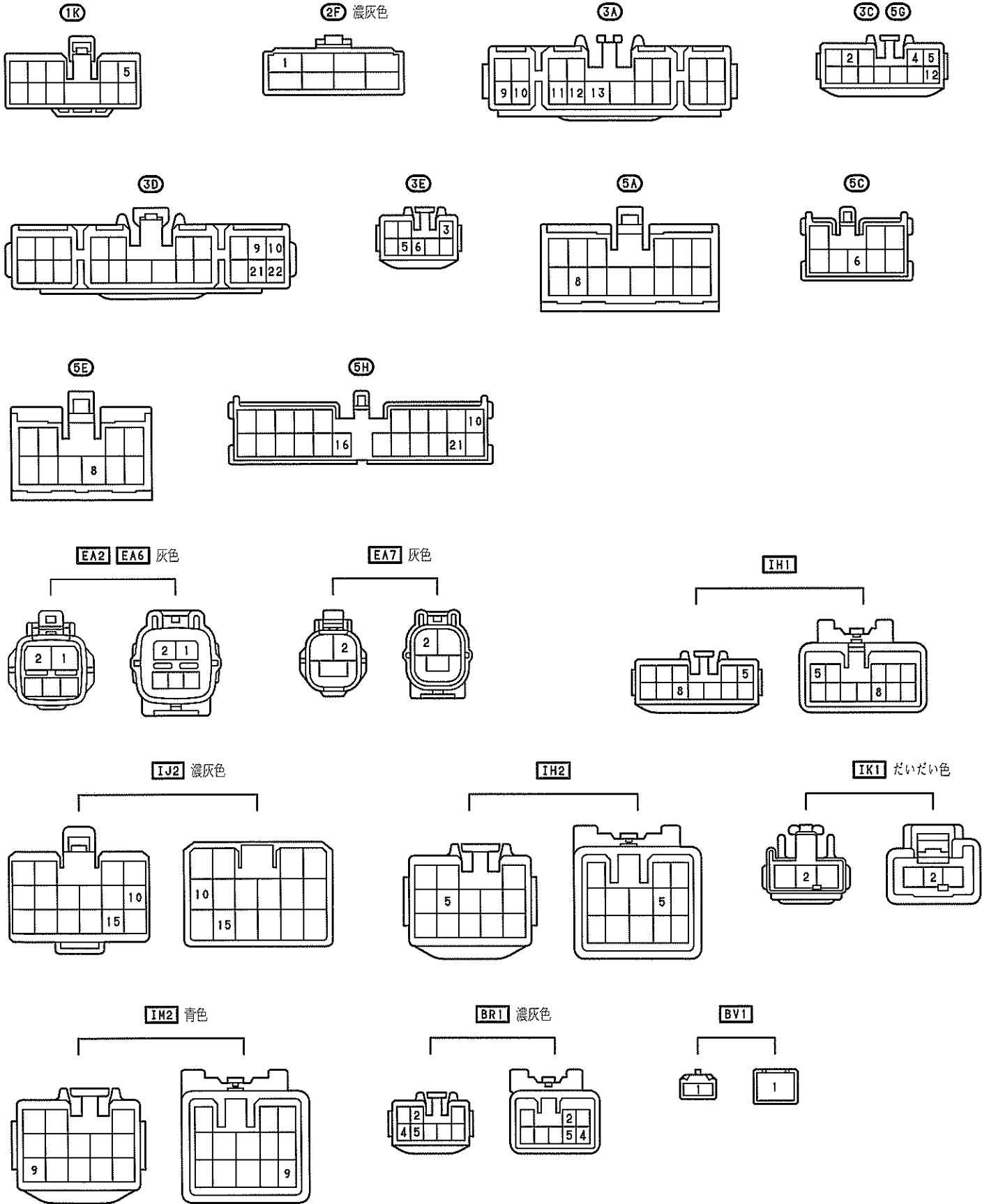

MEMO