

システム別配線図

電源(電源—負荷)
J/B NO.1(右カウル サイド)

電 源	負 荷	ページ	
7.5A	ラジオ	サイド ウインドウ ワイパ リレー	94
		リモート コントロール アクチュエータ	134, 135
		ラジオ & ステレオ(4スピーカー)	146
		ラジオ & ステレオ(6スピーカー)	148
15A	ラジオ	シフト ロック コントロール リレー	137
		無線機	142
		シガレット ライタ, クロック	145
15A	エンジン	オルタネータ	28
7.5A	イグニッション	チャージ ウォーニング ランプ	28
		メイン リレー, エンジン コントロール コンピュータ	30, 34, 40, 41, 46, 47, 48
		エンジン コントロール コンピュータ, VSV No.2, VSV(EGR), VSV No.1, VSV(吸気制御), フューエル カット ソレノイド	58, 59
		エミッション コントロール コンピュータ, VSV(フューエル カット) インジェクタ リレー, インジェクタ	62
		フューエル ヒータ リレー	64
		フューエル バルブ ソレノイド	65
		エンジン コントロール コンピュータ	114, 115
		コンビネーション メータ, 補助スピード メータ(教習車教官用)	150, 151
		コンビネーション メータ	154, 155
		ファン サブ リレー, メイン リレー, ファン メイン リレー	160
		ラジエータ ファン リレー No.1, メイン リレー(イグニッション) コンデンサ ファン リレー No.2	171, 172, 173, 174, 175
		7.5A	スタータ
スタータ ソレノイド, フューエル バルブ コントロール リレー	62		
フューエル バルブ コントロール リレー	65		
コンビネーション メータ	154, 155		
エアコン カット リレー	162, 165, 169, 171, 178, 184, 190		
20A	ワイパ	ウオツシャ モータ, ワイパ モータ, ワイパ & ウオツシャ スイッチ(コンビ スイッチ), ウインドシールド ワイパ リレー	90, 91
		ウオツシャ モータ, ウオツシャ チエンジ バルブ, リヤ ワイパ モータ リレー, リヤ ワイパ & ウオツシャ スイッチ	92
		サイド ウインドウ ワイパ リレー	94
15A	エレクトロニクス B	コンライト スキャナ	68
		タクシー端子(料金メータ)	89
		ESC コンピュータ	122, 123
		ミラー コントロール リレー	134, 135
15A	エレクトロニクス IG	コンライト スキャナ	68
		タクシー端子(タコグラフ)	89
		ドア コントロール リレー	102, 103, 110
		パワー ステアリング コンピュータ	120

電 源	負 荷	ページ	
15A	エレクトロニクス IG	ESC コンピュータ	122, 123
		アブソバ コントロール コンピュータ, ステアリング センサ, インジケータ ランプ(コンビメータ)	127, 128
		A/D コンピュータ	130, 131
		シフト ロック コントロール リレー	137
		クリアランス ウォーニング デイスプレイ	138, 139
		無線機	142
		エア ビュリフアイア スイッチ(オート, マニュアル), エア ビュリフアイア	158
7.5A	ターン	ノイズ フィルタ, ターン シグナル ランプ, ターン シグナル インジケータ ランプ, ターン シグナル フラッシュヤ	76, 77
15A	ストップ ランプ	エンジン コントロール コンピュータ	42, 43, 48, 49, 54, 55, 114, 115
		ランプ フェイリア センサ	79, 82
		ノイズ フィルタ, ストップ ランプ	79
		ESC コンピュータ	122, 123
		アブソバ コントロール コンピュータ	127, 128
		A/D コンピュータ	130, 131
		シフト ロック コントロール リレー	137
15A	フォグ ランプ	フォグ ランプ	88
7.5A	メーター	チェック エンジン ウォーニング ランプ, 排気温センサ, スーパー チャージャ インジケータ ランプ(IG-GZE), ターボ インジケータ ランプ(IG-GTE)	31, 42, 43, 49, 54, 55
		グロー インジケータ ランプ, タコメータ	59
		排気温ランプ	62
		バック アップ ランプ	80
		ランプ フェイリア センサ, リヤ ライト ウォーニング ランプ	82
		インテグレーション リレー	112
		O/D OFF インジケータ ランプ	114, 115, 118
		トランスミッション インジケータ ランプ	114, 115, 117
		エンジン コントロール コンピュータ	114, 115
		O/D リレー, O/D ソレノイド	118
		ESC コンピュータ, ブレーキ ウォーニング ランプ, ESC インジケータ ランプ	122, 123
		A/D インジケータ ランプ	130, 131
		クリアランス ウォーニング コンピュータ	138, 139
		コンビネーション メータ	150, 151, 154, 155
		レオスタット	154, 155
		ヒータ リレー	162, 165, 169, 175, 181, 187, 193
		システム アンプ, モード コントロール サーボ, エア インレット サーボ ヒータ コントロール & エアコン スイッチ	171, 172, 173, 174, 178, 179, 180, 181, 184, 185, 186, 187, 190, 191, 192, 193

電 源	負 荷	ページ	
7.5A	メータ	ブロー運動リレー, ブロー ハイ リレー	190, 191, 192, 193
15A	テール ランプ	エンジン コントロール コンピュータ	42, 43, 54, 55, 114, 115
		クリアランス ランプ	70, 71
		ランプ フェイリア センサ	70, 71, 82
		テール ランプ, ライセンス プレート ランプ	70, 71
		シガレット ライト照明, グロー ボックス ランプ, ステップ ランプ, サブ メータ照明, A/T インジケータ ランプ, ハザード スイッチ照明, コンビメータ照明, トランスミツション インジケータ照明, デイフオツガ スイッチ照明, パターン セレクト スイッチ照明, アブソーバ コントロール スイッチ照明, ラジオ照明, エアコン スイッチ照明, ヒータ コントロール スイッチ照明, エア ピュリファイア スイッチ照明	72, 73, 74
		フォグ ランプ リレー	88
		タクシー端子(料金メータ), タクシー端子(タコグラフ)	89
		クリアランス ウォーニング コンピュータ	138, 139
		クロック	145
		レオスタット	154, 155
		30A	C/B パワー
パワー シート モータ	98, 99, 100		
ドア コントロール スイッチ, パワー ウィンドウ モータ, ドア コントロール リレー	102, 103		
メイン リレー	106, 107		
スライディング ルーフ コントロール リレー	110		
30A	C/B デイフオツガ	デイフオツガ リレー, ノイズ フィルタ, リヤ ウィンドウ デイフオツガ(ウィンドシールド アンテナ車)	112
20A	C/B ドア ロック	ドア コントロール リレー	106, 107

J/B NO.2(エンジン ルーム)

15A	ヘッドランプ(右)	ヘッドランプ(RH)	66
15A	ハザード・ホーン	ノイズ フィルタ	76
		ホーン	144
15A	ヘッドランプ(左)	ヒューズ電気負荷アイドル アップ(R/B No.4)	27
		ヘッドランプ(LH)	66
15A	AM2	イグニツション スイッチ(AM2)	18
20A	ルーム ランプ	エンジン コントロール コンピュータ	59
		マップ ランプ, ルーム ランプ, ドア カーテシ スイッチ, イグニツション キー照明, 半ドア ウォーニング ランプ, インテグレーション リレー, ラツゲージ ルーム ランプ	84, 85
		サイド ウィンドウ ワイパ リレー	94
		ドア コントロール レシーバ(ワイヤレス ドア ロック付)	106, 107
		クロック	145
		ラジオ & ステレオ(4スピーカ)	146
		ラジオ & ステレオ(6スピーカ)	148
		コンビネーション メータ	154, 155
20A	EFI	エンジン コントロール コンピュータ, サーキット オープニング リレー, フューエル ポンプ, ダイアグノーシス コネクタ, アイドル スピード コントロールバルブ, ISC ステップ モータ(1G-GE), VSV(T-VIS)(1G-GE), スーパーチャージャ リレー(1G-GZE), スーパーチャージャ マグネット クラッチ(1G-GZE), VSV 1(1G-GZE), VSV 2(1G-GZE), VSV(EPU)(1G-GTE), O ₂ センサ(1G-GTE), フューエル ポンプ リレー(1G-GZE, 1G-GTE), フューエル ポンプ レジスタ(1G-GZE, 1G-GTE)	30, 31, 34, 35, 40, 41, 46, 47, 48, 52, 53, 54

電 源		負 荷	ページ
20A	EFI	エンジン コントロール コンピュータ	114, 115
20A	フューエル ヒータ	フューエル ヒータ	64
15A	テレフォン	無線機	142

R/B NO.4(左カウル サイド)

10A	電気負荷アイドル アップ	アイドル アップ ダイオード	27
10A	エアコン	ブロワ モータ	161, 162, 165, 169
		ヒータ コントロール & エアコン スイッチ, エアコン アンプ, マグネット クラッチ, マグネット クラッチ リレー, コンデンサ ファン リレー No.3(4S-Fi Eグレード), コンデンサ ファン リレー	173, 174, 175, 187, 193
		ヒータ コントロール & エアコン スイッチ, マグネット クラッチ リレー, マグネット クラッチ, コンデンサ ファン リレー	181
40A	C/B ヒータ	ブロワ モータ, ヒューズ エアコン, エアコン アンプ, マグネット クラッチ リレー, マグネット クラッチ, コンデンサ ファン リレー, VSV(アイドル アップ)(3Y-P)	160, 161, 162, 164, 165, 168, 169
		ブロワ モータ, ヒューズ エアコン, ヒータ コントロール & エアコン スイッチ, エアコン アンプ, マグネット クラッチ, マグネット クラッチ リレー, コンデンサ ファン リレー No.3(4S-Fi Eグレード), コンデンサ ファン リレー	171, 172, 173, 174, 175, 178, 179, 180, 181, 184, 185, 186, 187
		ブロワ モータ, ヒューズ エアコン, ヒータ コントロール & エアコン スイッチ, エアコン アンプ, マグネット クラッチ リレー, マグネット クラッチ	190, 191, 192, 193

ヒュージブル リンク ボックス(エンジン ルーム)

10A	アイドル アップ	アイドル アップ ダイオード	27
60A	ESC	ESC アクチュエータ	122, 123
30A	ラジエータ ファン	ヒューズ ファン アイドル アップ(FL ボックス)	27
		ラジエータ ファン モータ, ファン メーン リレー	160
		ラジエータ ファン モータ, コンデンサ ファン リレー, No.2	175
80A	グロー	グロー プラグ, グロー プラグ レジスタ	58
100A 80A (注1)	オルタ	C/B デイフオツガ, ヒューズ ストップ ランプ, ヒューズ エレクトロニクス B, C/B ヒータ, ヒューズ フォグ ランプ, ヒューズ テール ランプ, テール ランプ リレー, FL AM1, FL コンデンサ ファン, FL ESC	18
		スタータ(2L, 2L-T A/T, 寒冷地)	20
		オルタネータ(IC レギュレータ付き)(除く3Y-P)	28
30A	コンデンサ ファン	コンデンサ ファン モータ, コンデンサ ファン モータ No.2(Q, V, Z グレード)	160, 164, 168, 175, 181, 187, 193
40A	AM1	C/B ドア ロック, イグニッション スイッチ(AM1), C/B パワー	18
		スタータ(除く2L, 2L-T A/T, 寒冷地), スタータ, ヒューズ スタータ	20, 22
		オルタネータ(IC レギュレータ付き)	28
30A	AM2	イグニッション スイッチ AM2	18
		IIA(3Y-P)	20
		イグニッション コイル(ガソリン除く1G-GTE), イグナイタ(ガソリン除く1G-GTE), イグニッション コイル & イグナイタ(1G-GTE), コンデンサ(ラジオ)	22, 23, 24, 25

ヒュージブル リンク(バッテリー横)

2.0L 3.0W (注2)	メーン	FL オルタ, FL AM2, ヒューズ AM2(ディーゼル), FL グロー(ディーゼル), ヒューズ EFI, ヒューズ ルーム ランプ, ヒューズ ハザード・ホーン, ヒューズ テレフォン(ガソリン), ヘッドランプ リレー, ヒューズ ヘッドランプ(右), ヒューズ ヘッドランプ(左)	18
----------------------	-----	---	----

(注1) 100A : 除く3Y-P教習車 80A : 3Y-P教習車
(注2) 2.0L : M/T, 3Y-P 3.0W : 除くM/T, 3Y-P

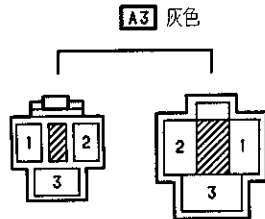
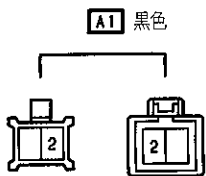
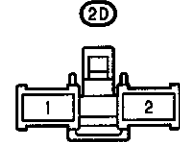
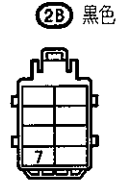
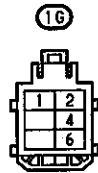
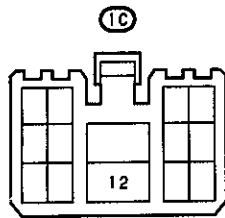
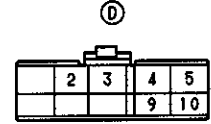
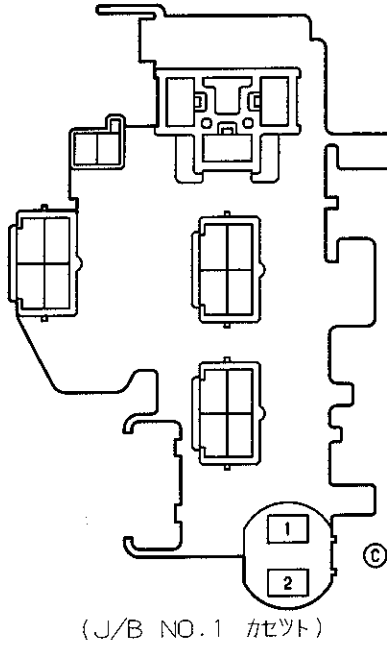
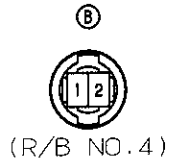
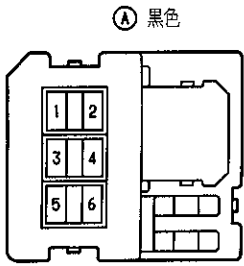



スターティング & イグニッション (除くガソリン)

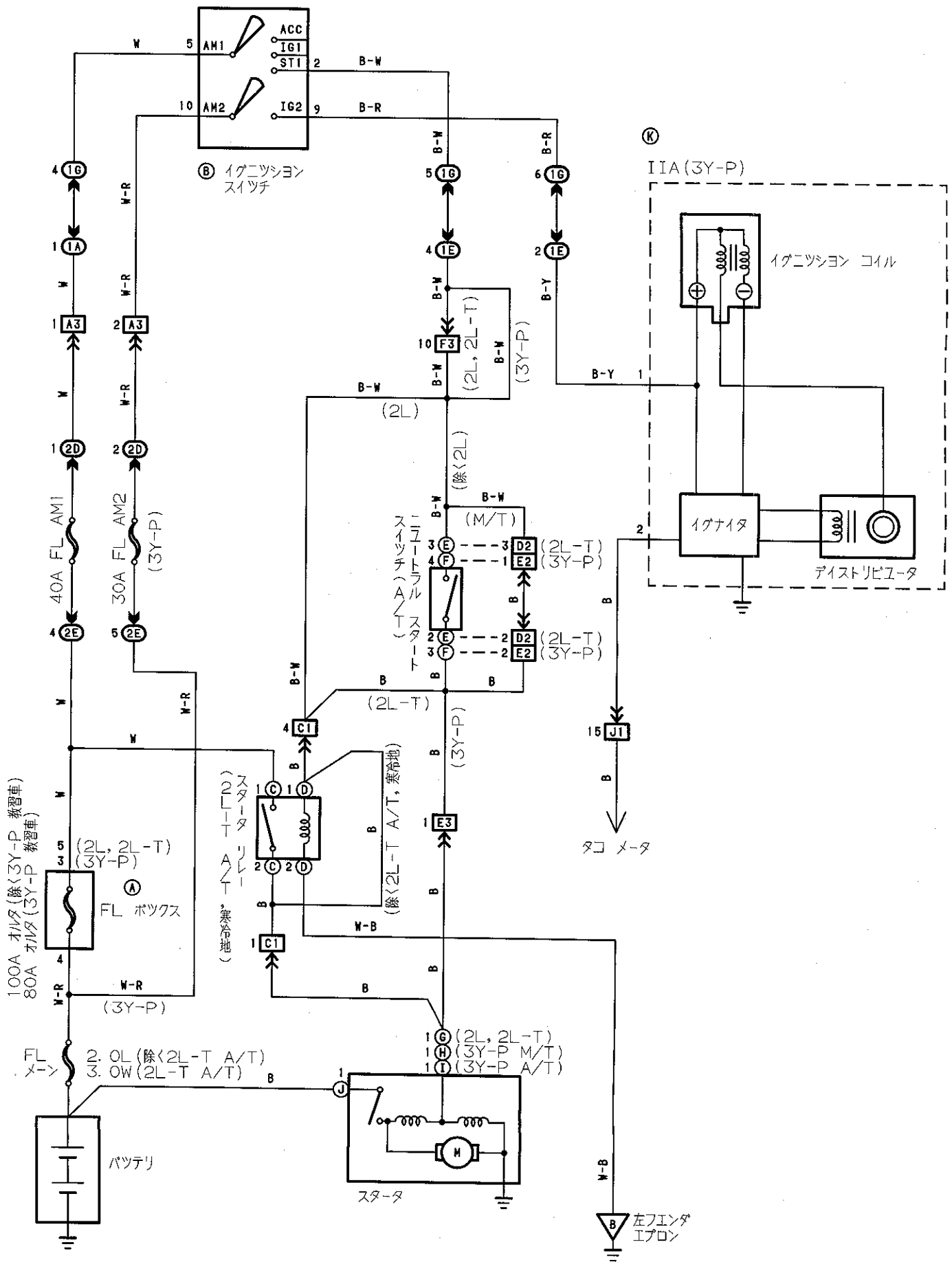

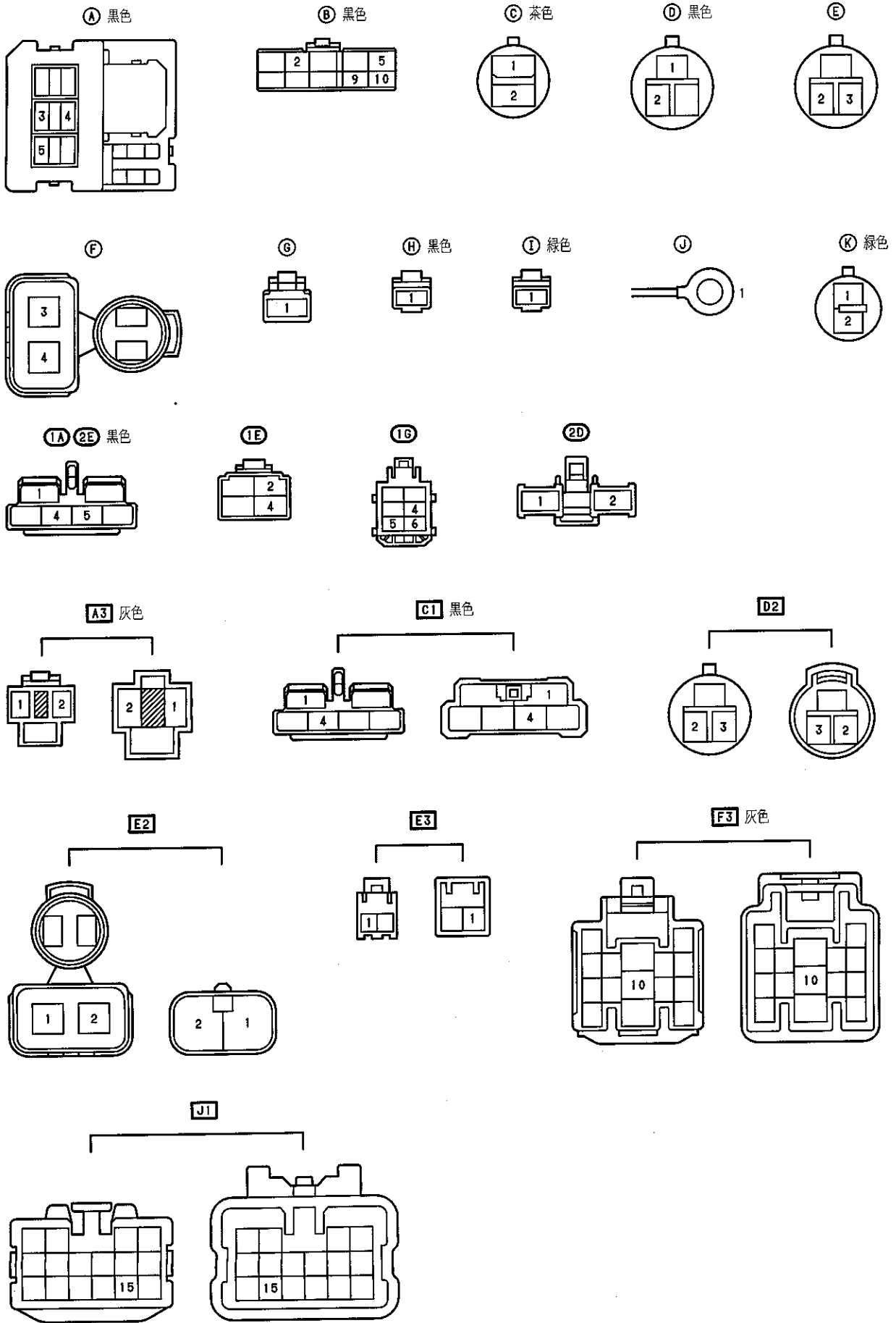



スターティング & イグニッション (ガソリン)

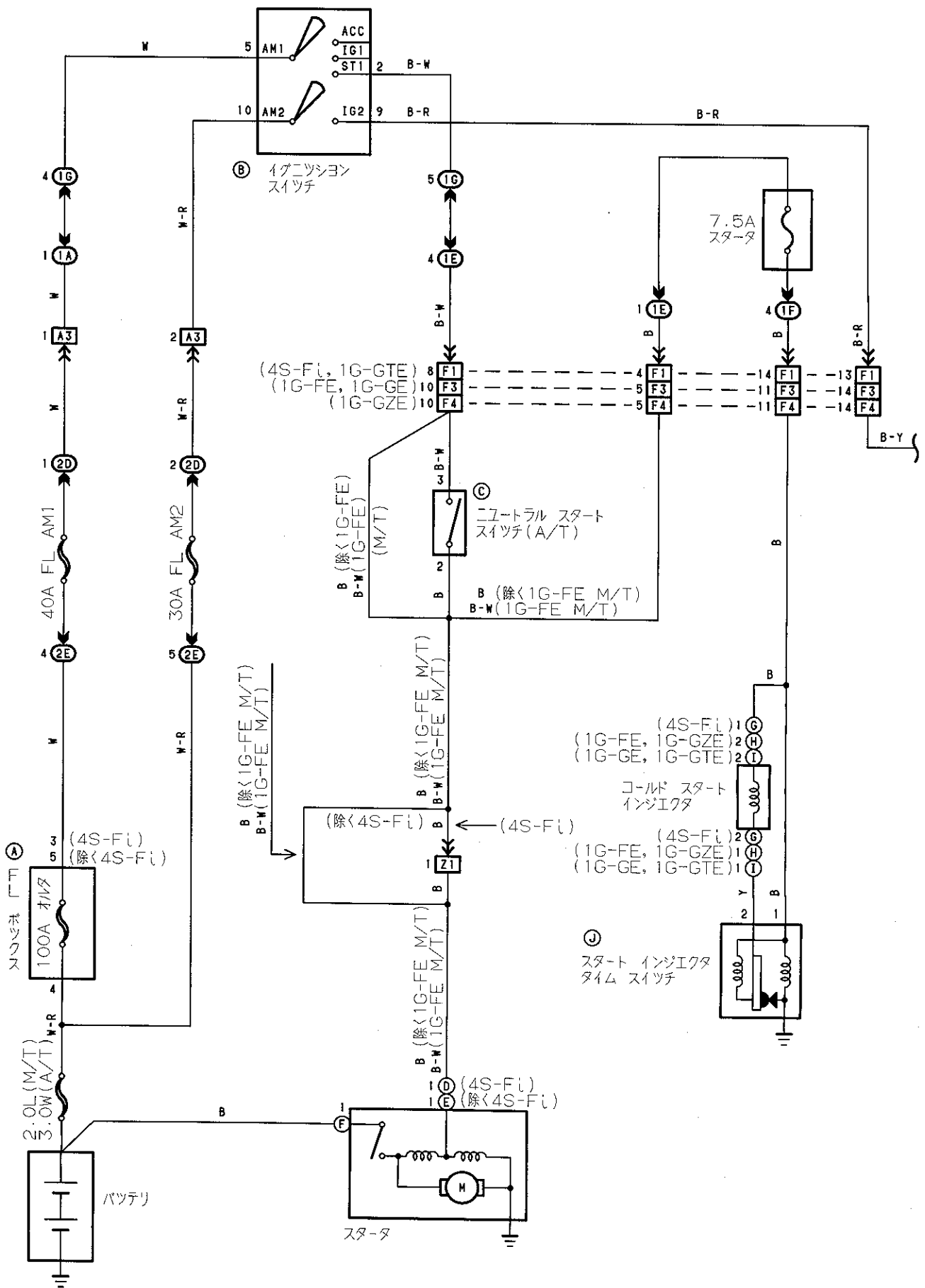

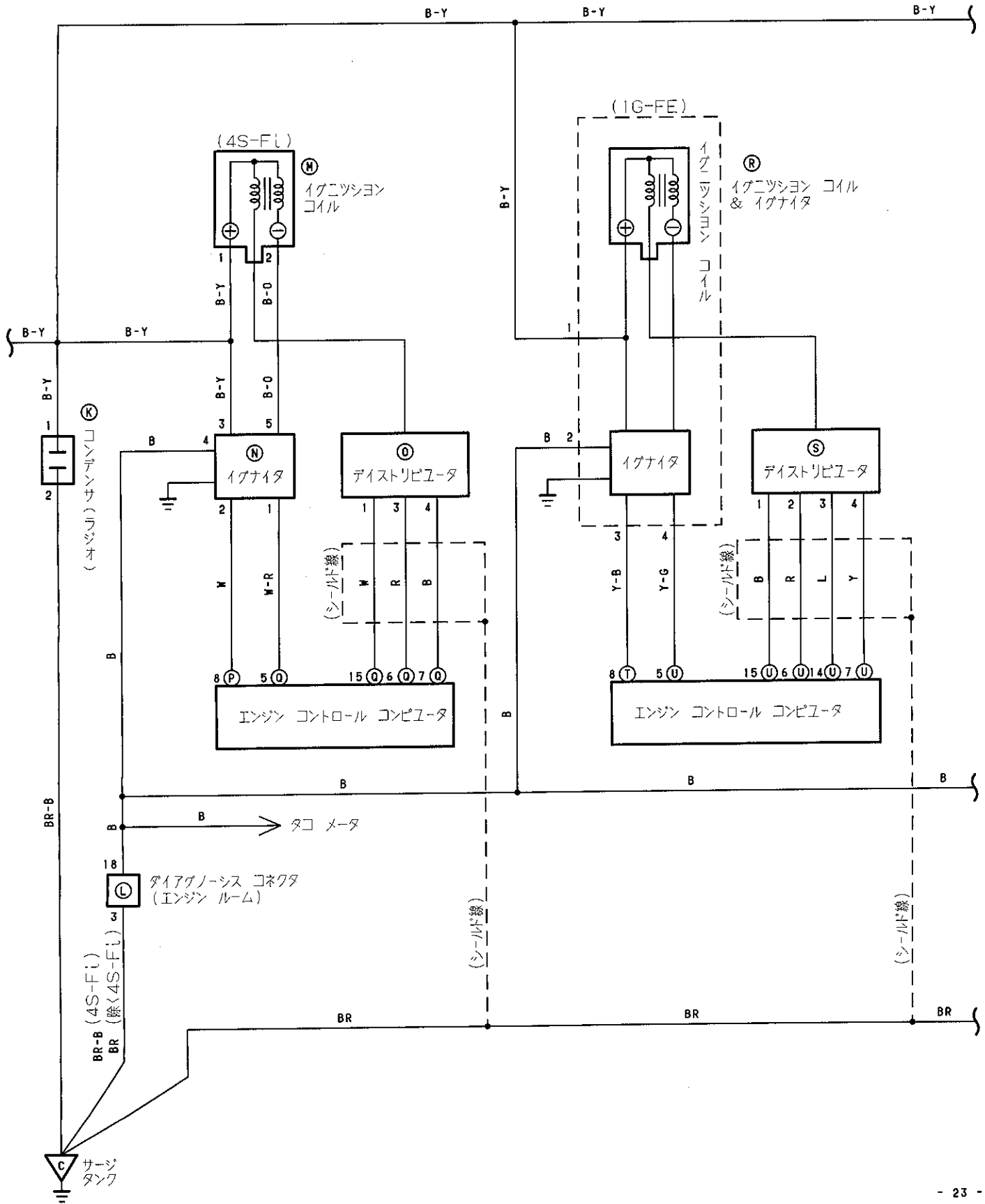



スターティング & イグニッション(ガソリン)

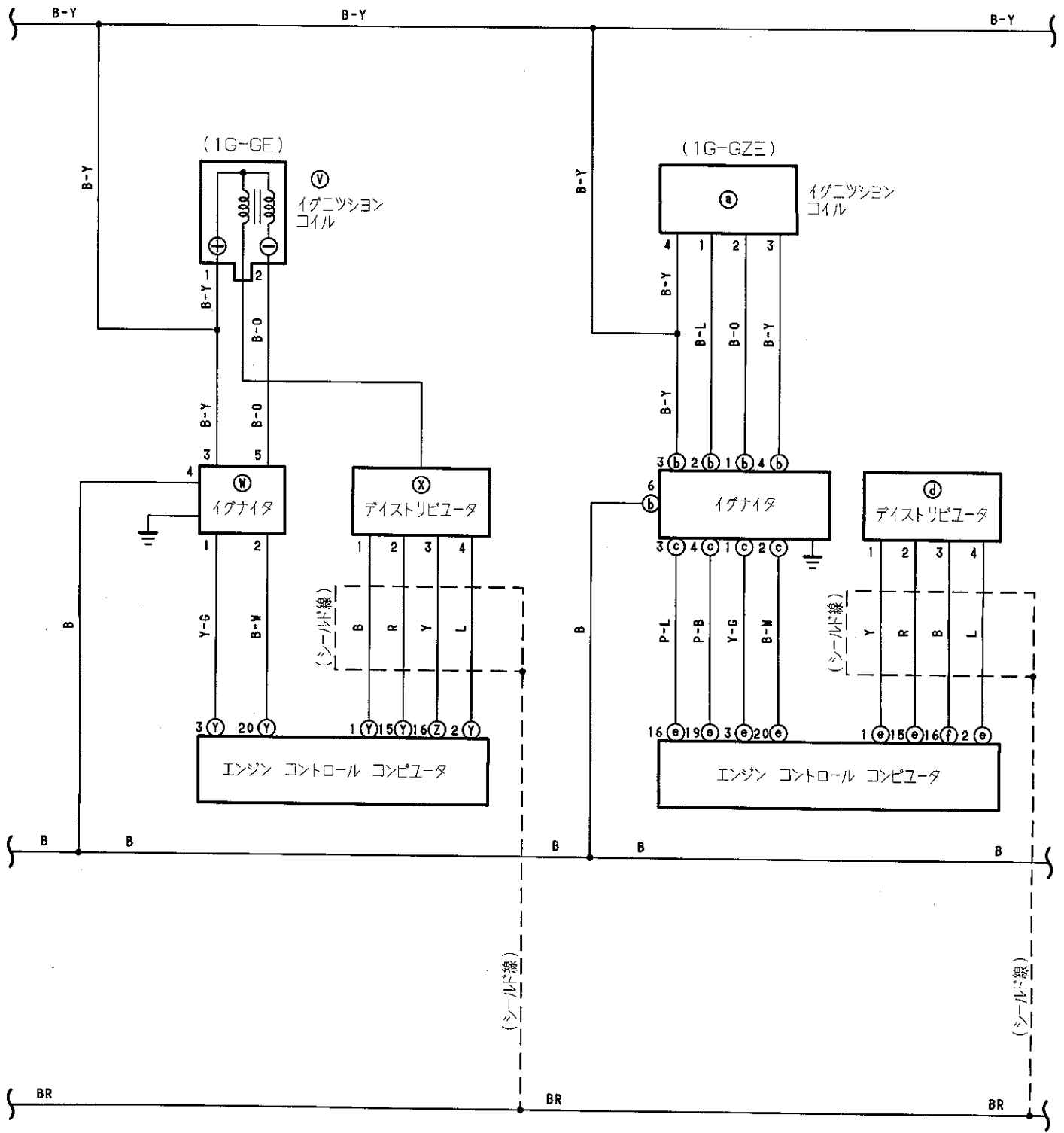

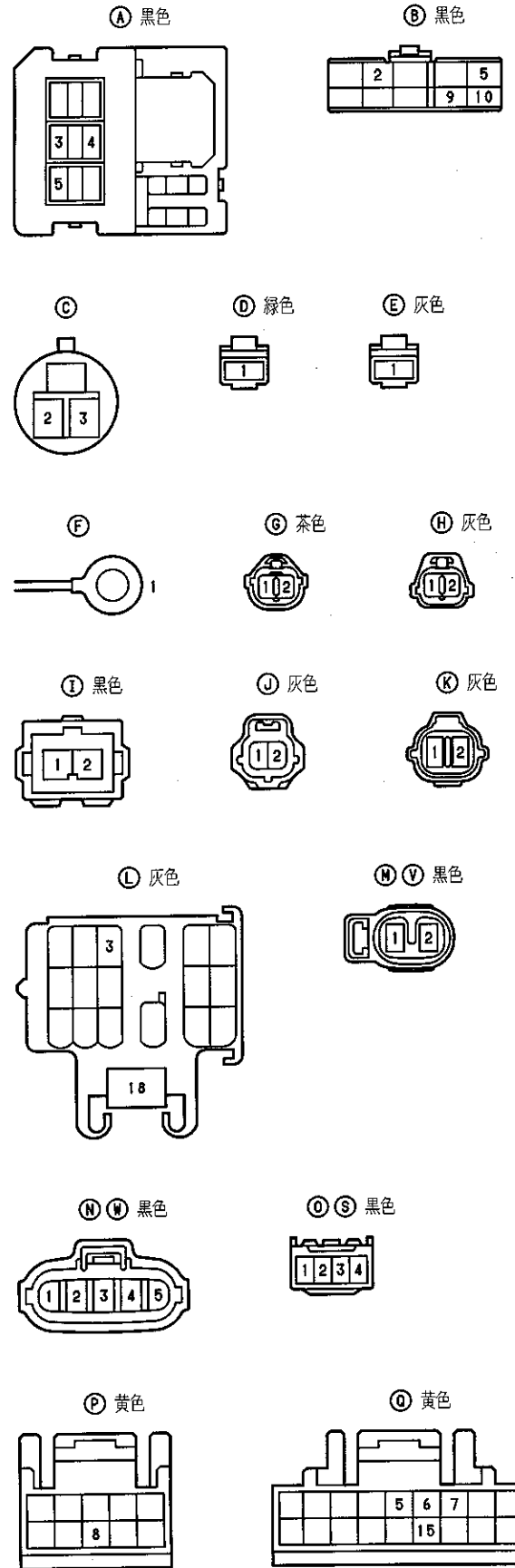
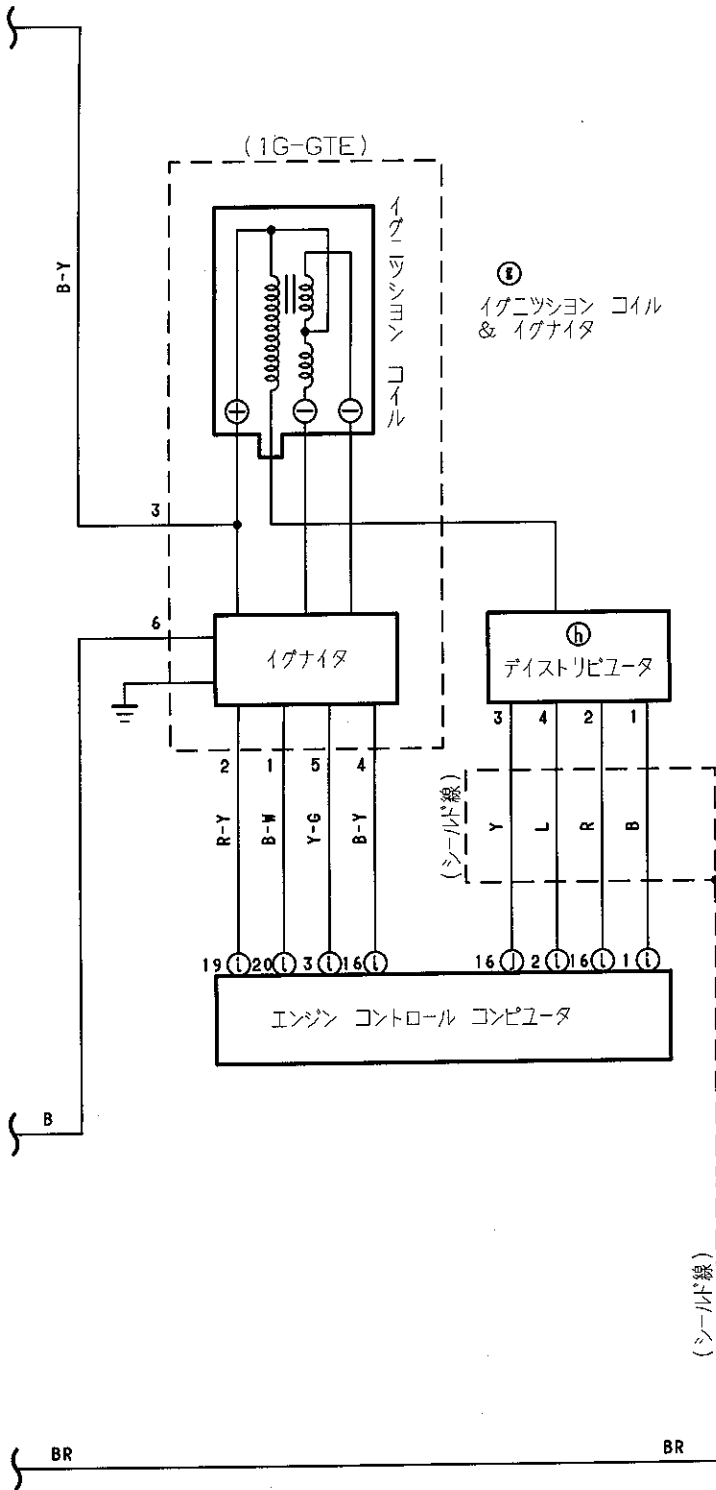



スターティング & イグニッション (ガソリン)

R X R C d 灰色



T 灰色

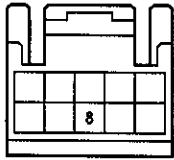

U 灰色

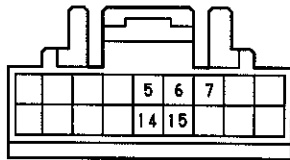

Y e 灰色

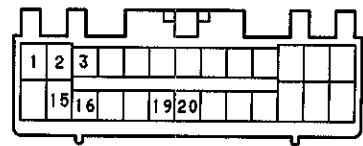

Z f 灰色

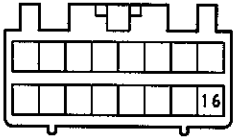

b p 灰色

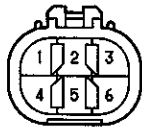

h 緑色



l 黄色

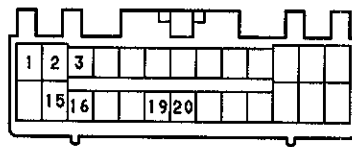

l 黄色

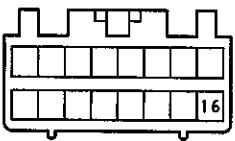

1A 2E 黒色

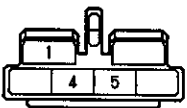

1E

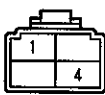

1F

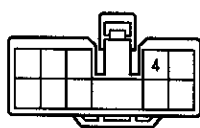

1G

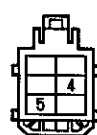

2D

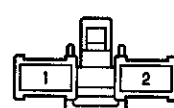

A3 灰色

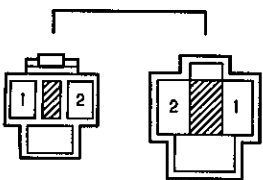

F1 黄色

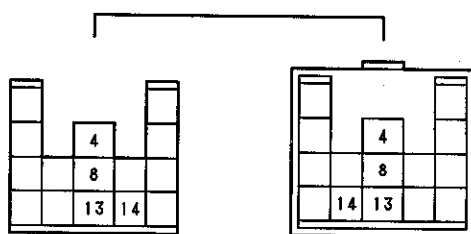

F3 灰色

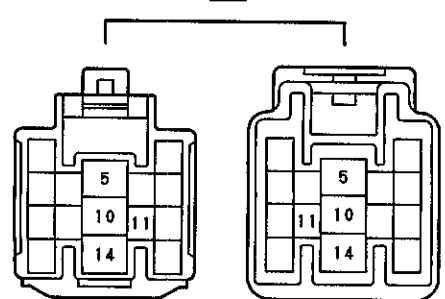

F4

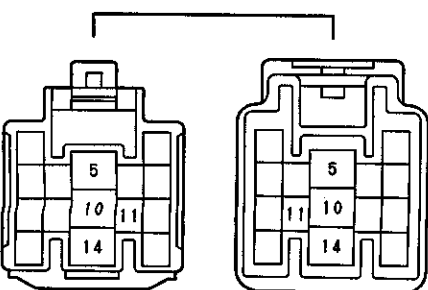

Z1

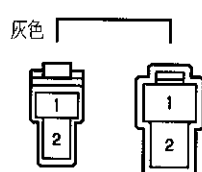

アイドル アツプ (4S-Fi)

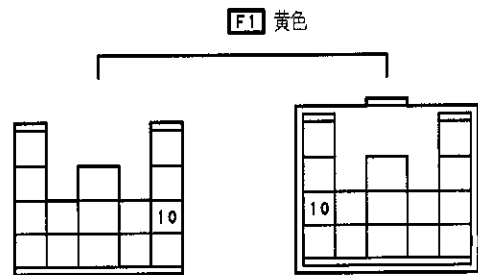
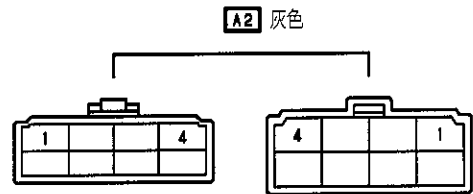
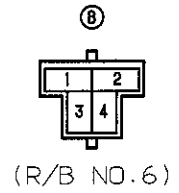
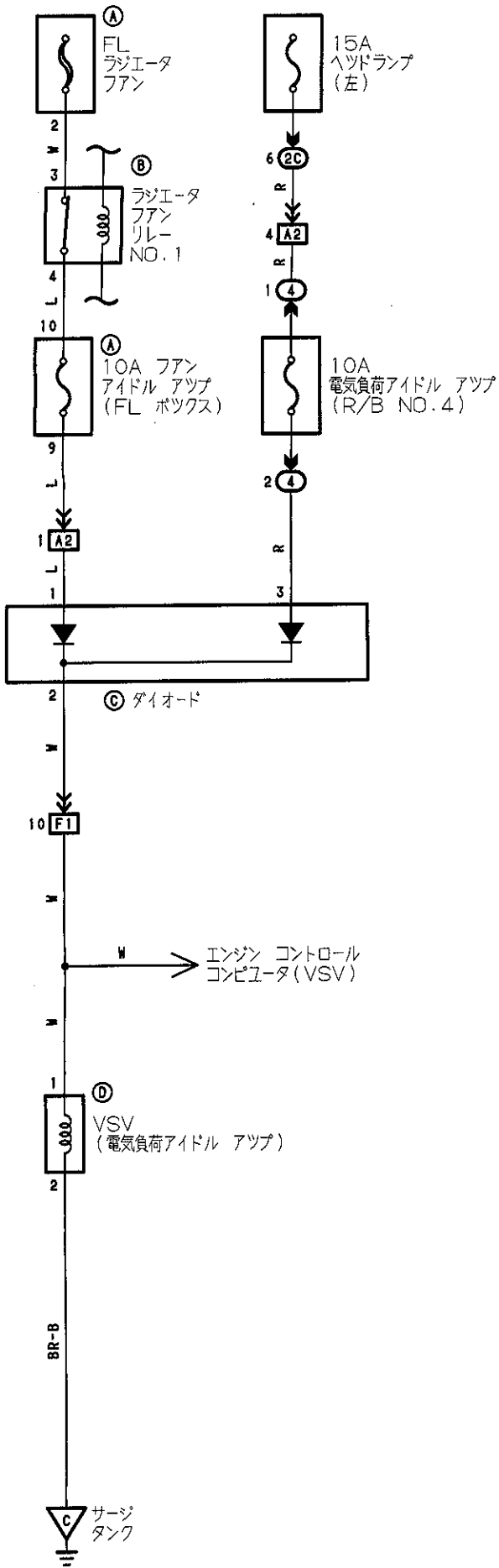

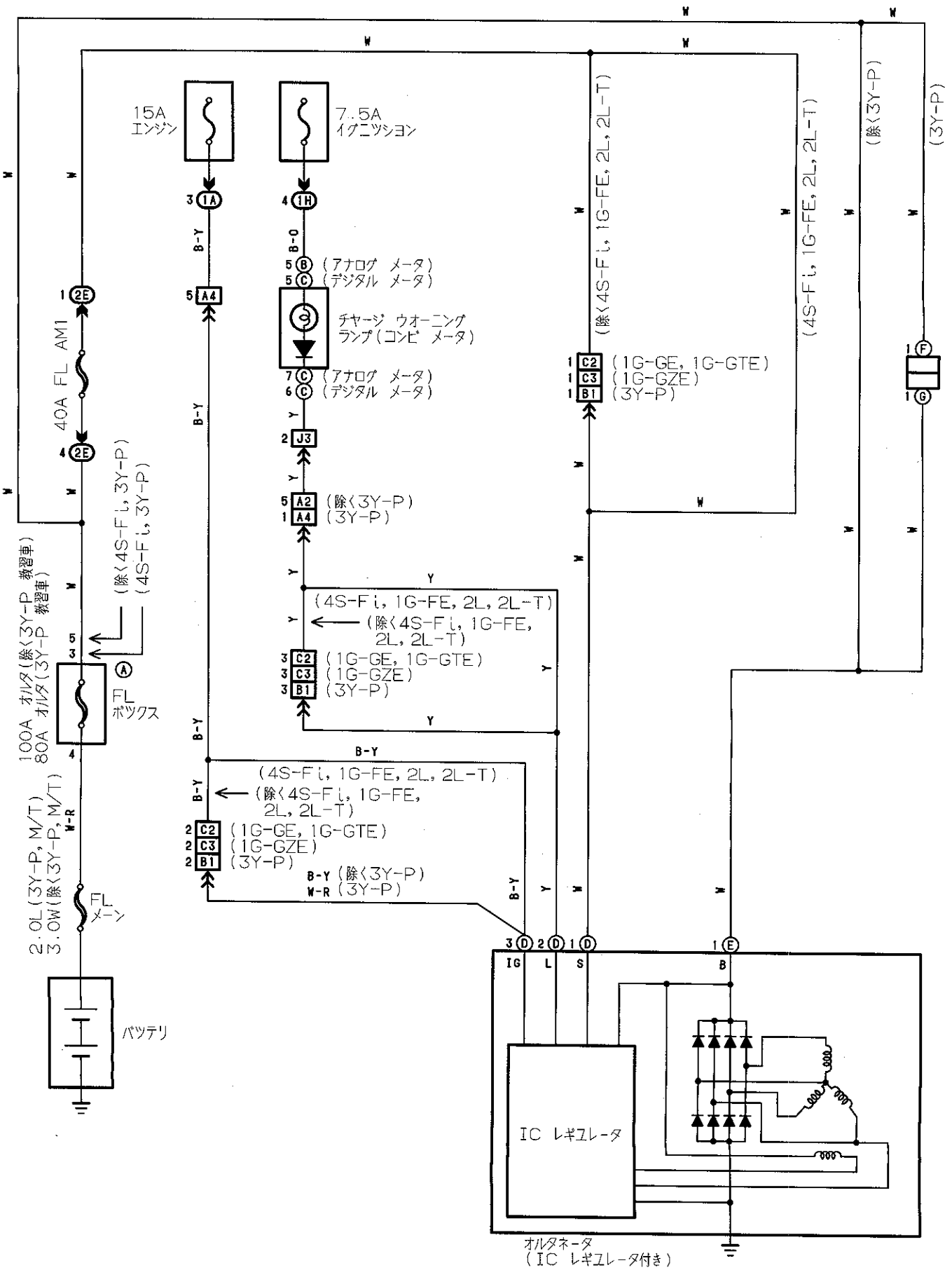

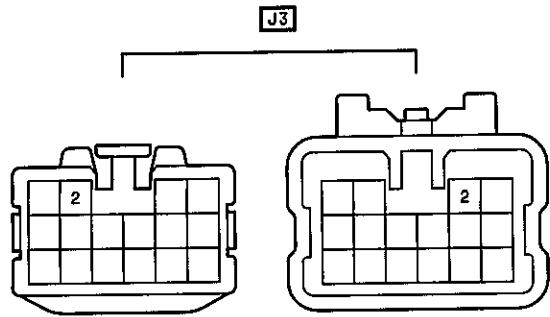
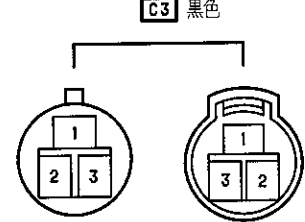
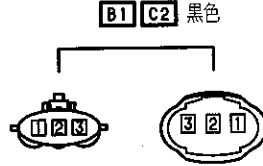
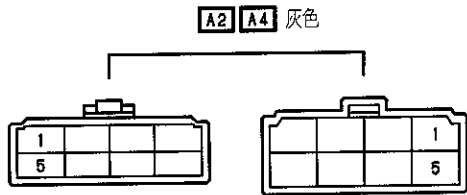
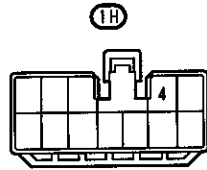
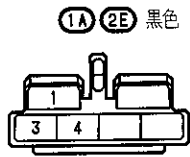
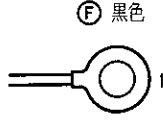
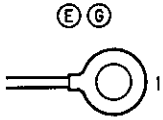
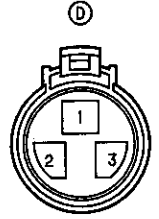
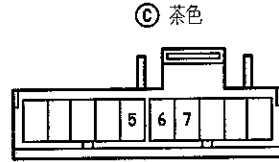
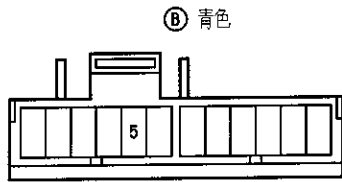
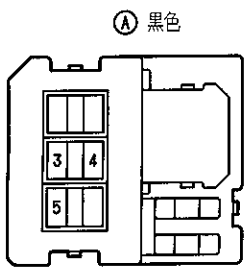

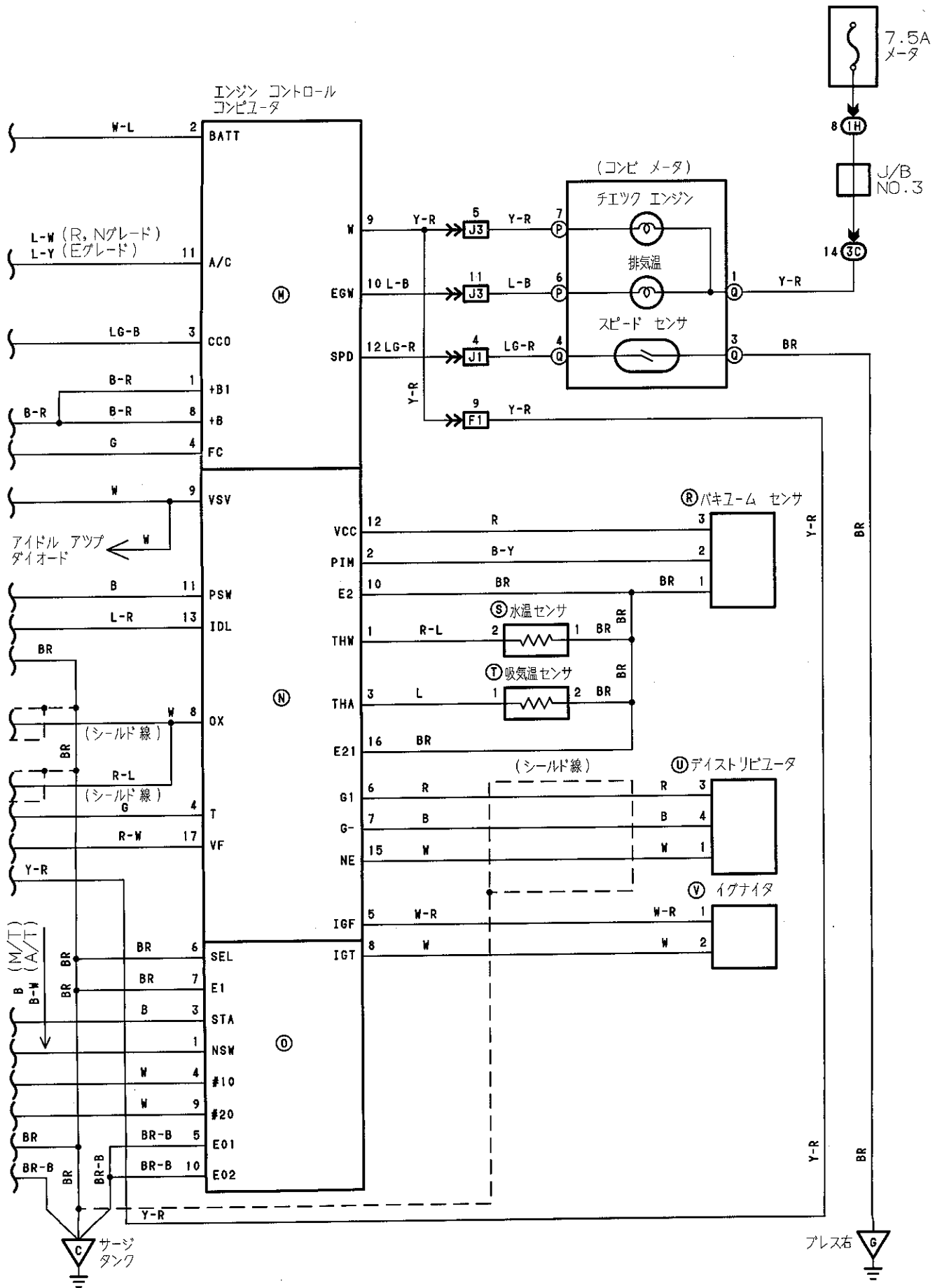

EFI (4S-Fl)

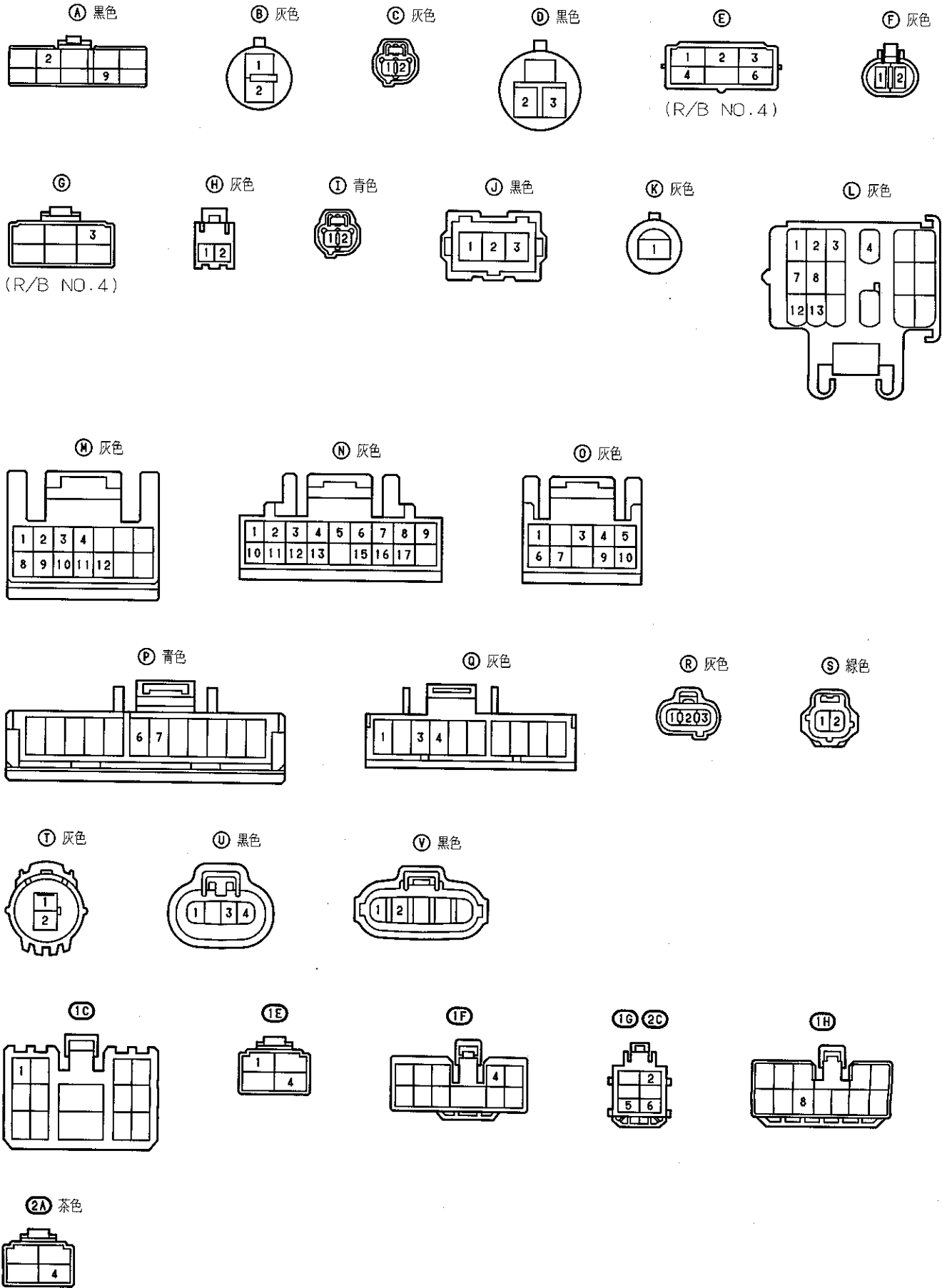

2B 黑色

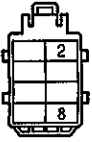

3C 青色

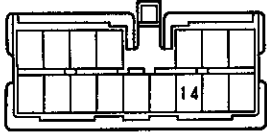

F1 黄色

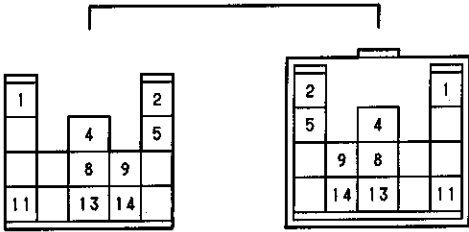

I2

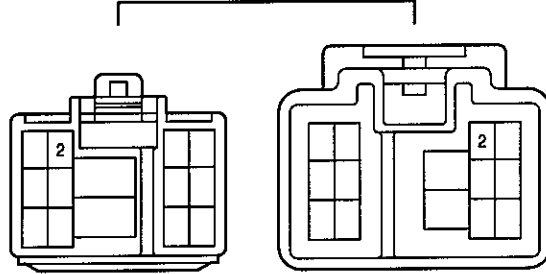

J1 J3

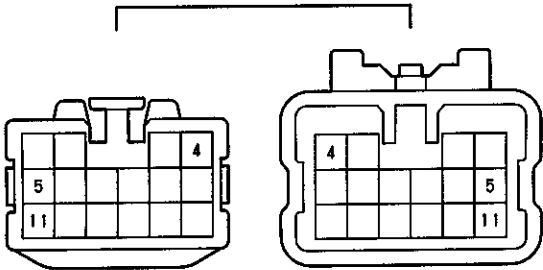

Q1

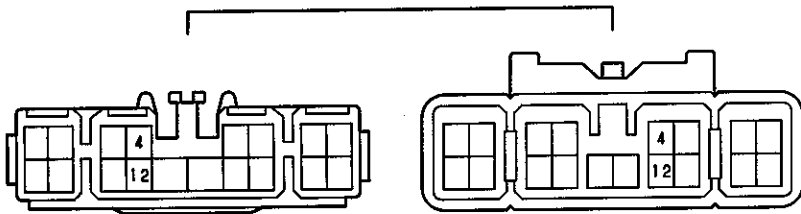



EFI (1G-FE)

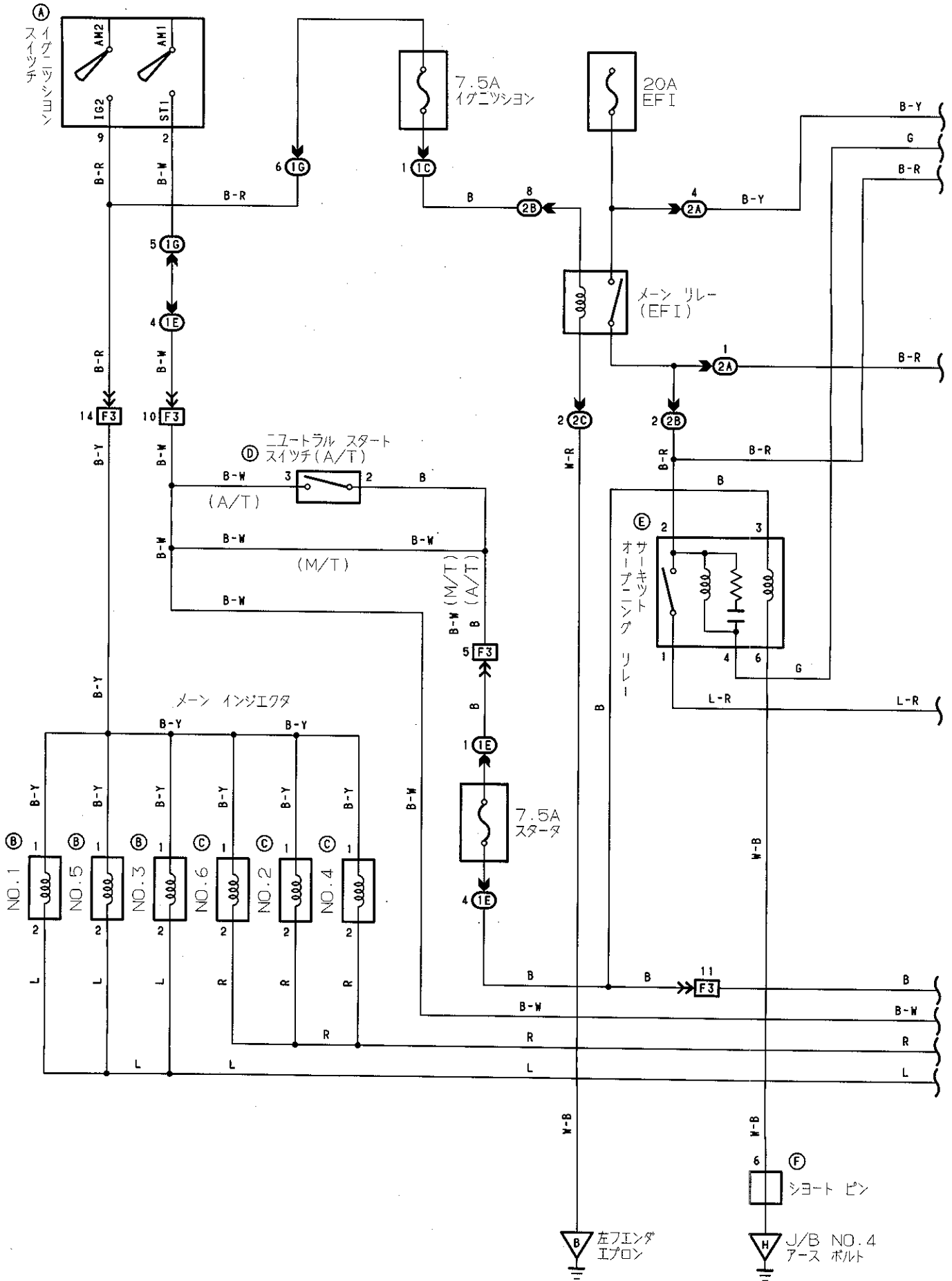

エンジン コントロール
コンピュータ

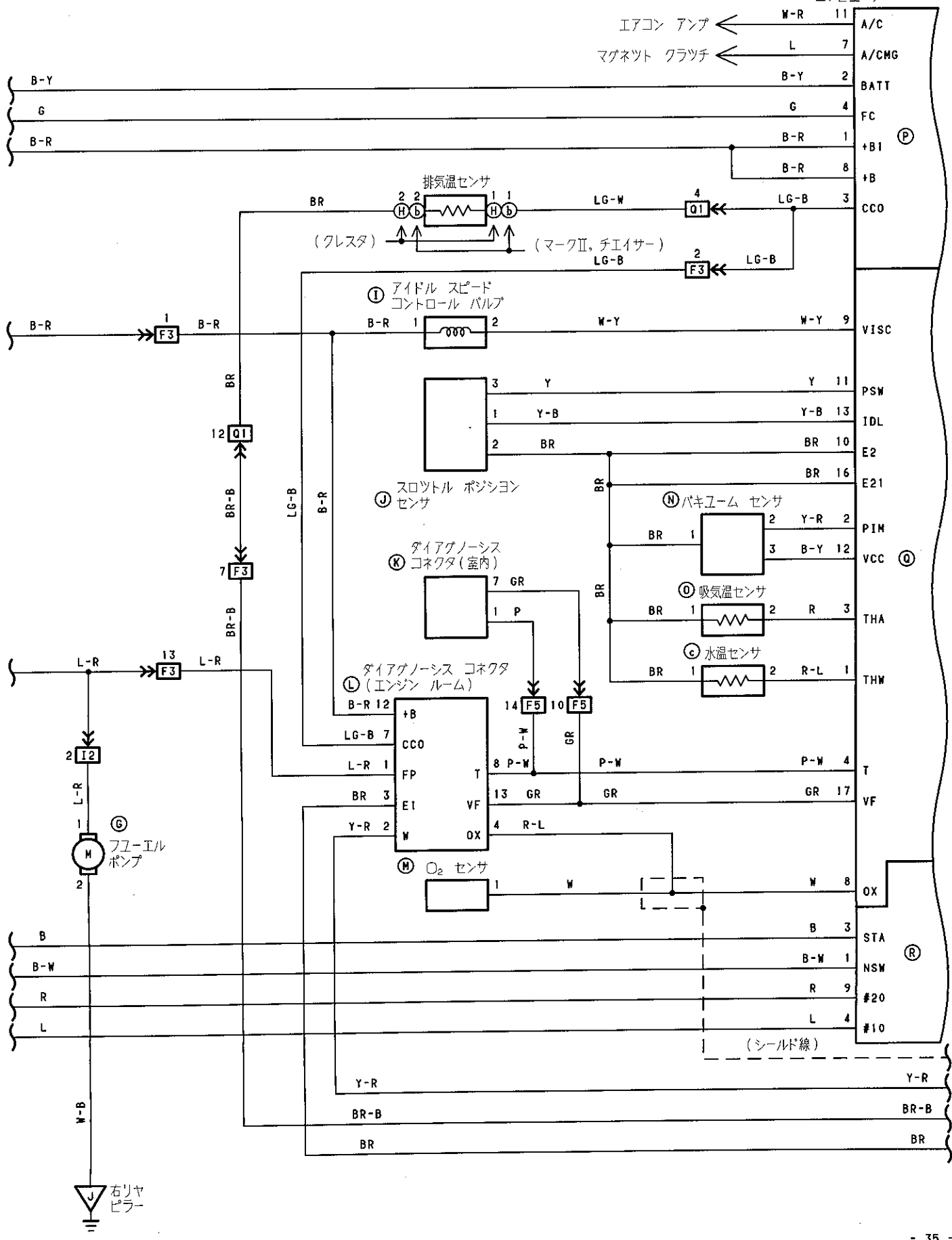

EFI (1G-FE)

エンジン コントロール
コンピュータ

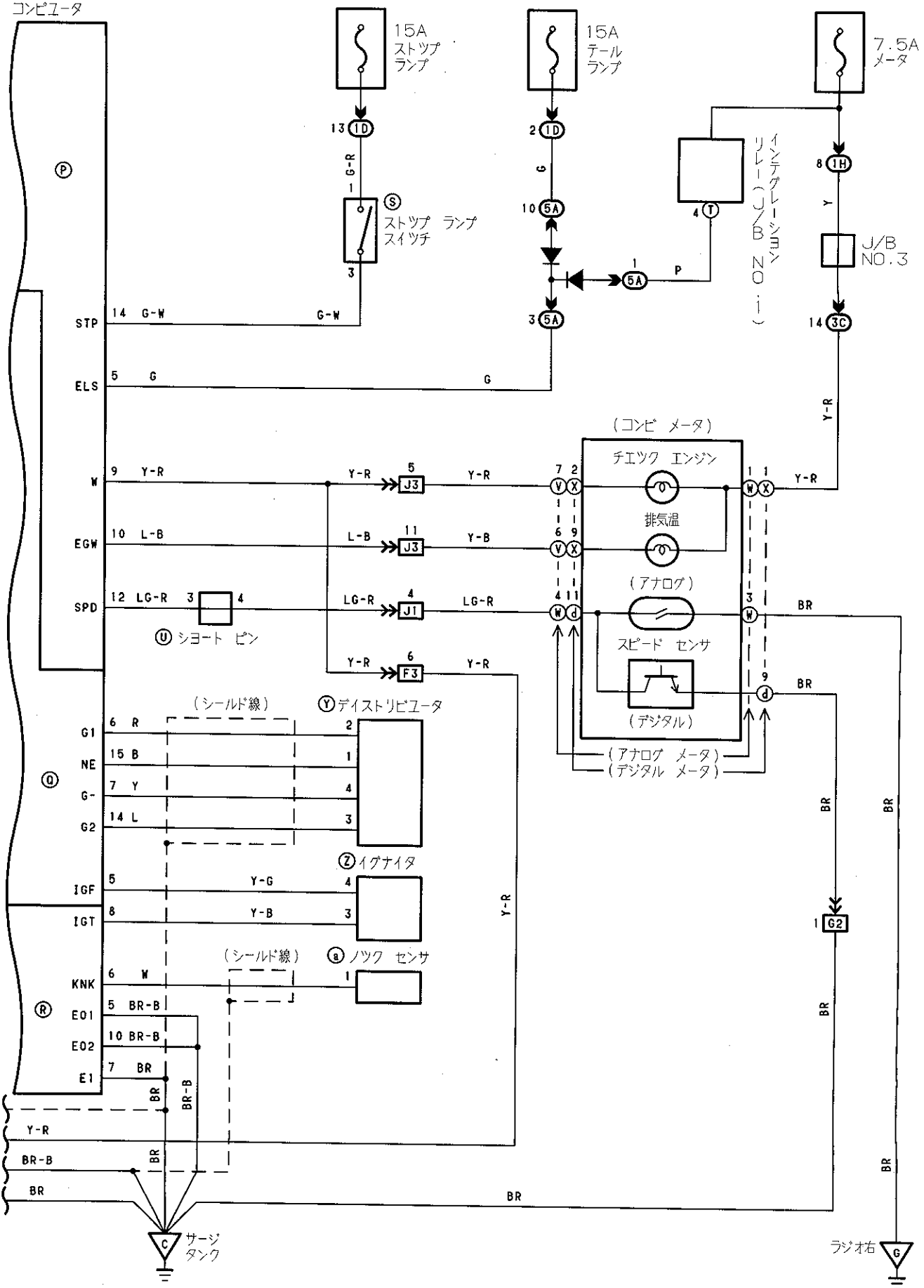

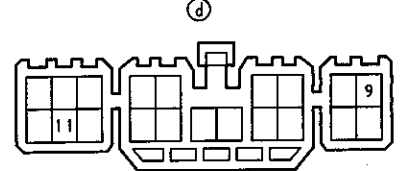
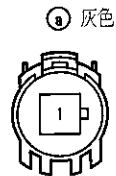
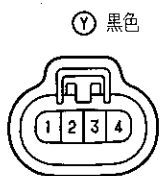
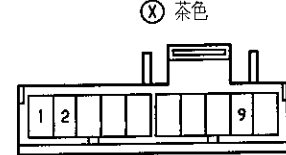
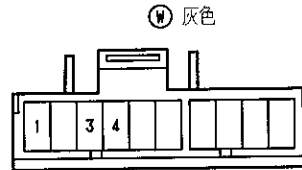
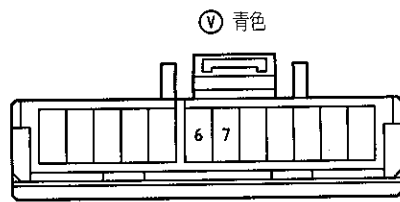
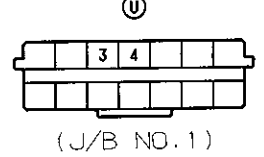
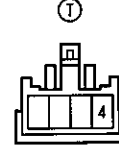
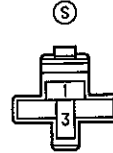
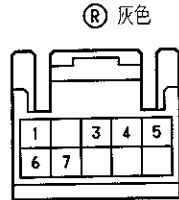
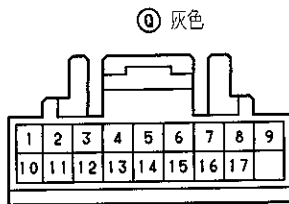
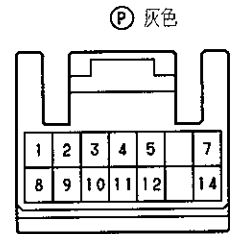
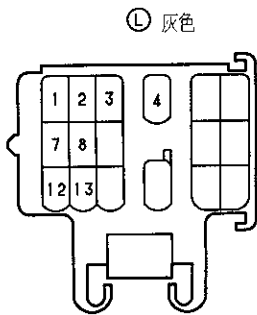
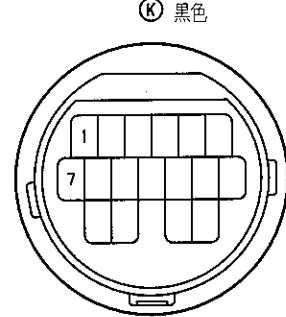
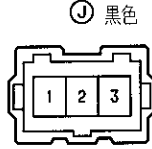
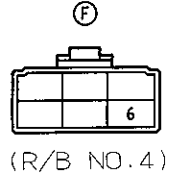
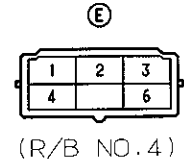
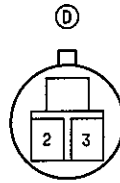
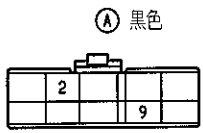

EFI EFI (1G-FE)

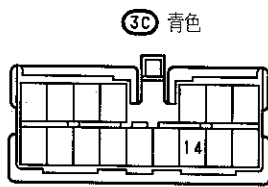
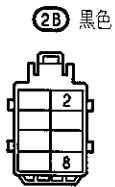
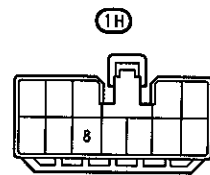
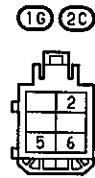
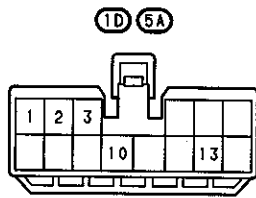
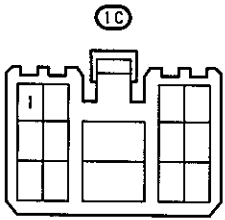

F3 灰色

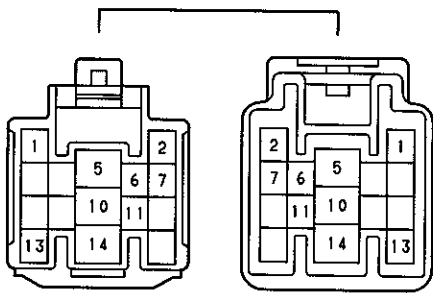

F5 灰色

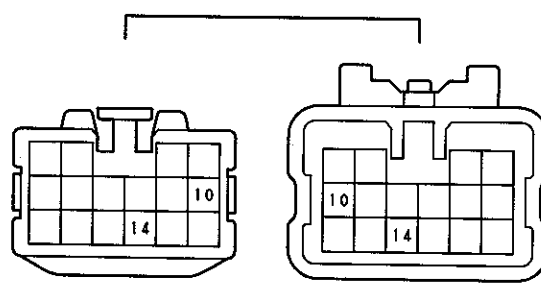

G2

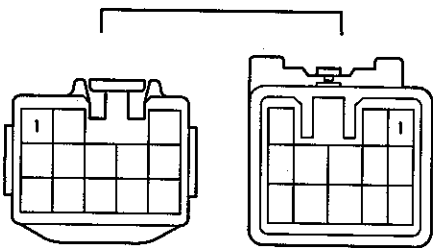

I2

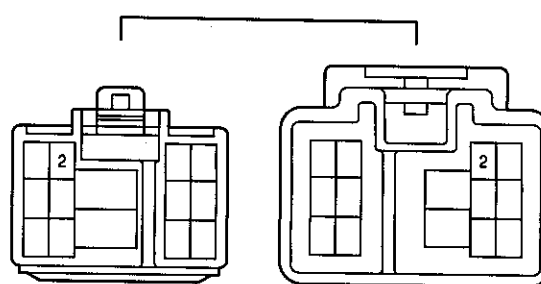

J1 J3

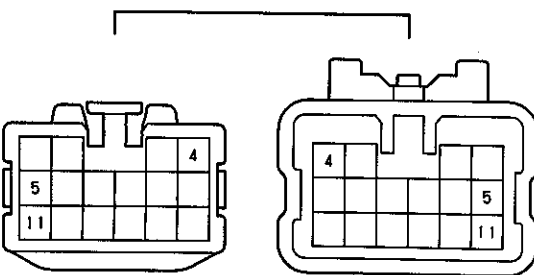

Q1

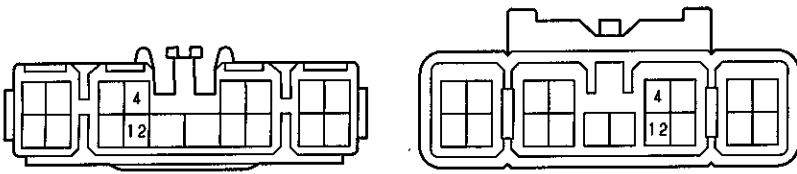

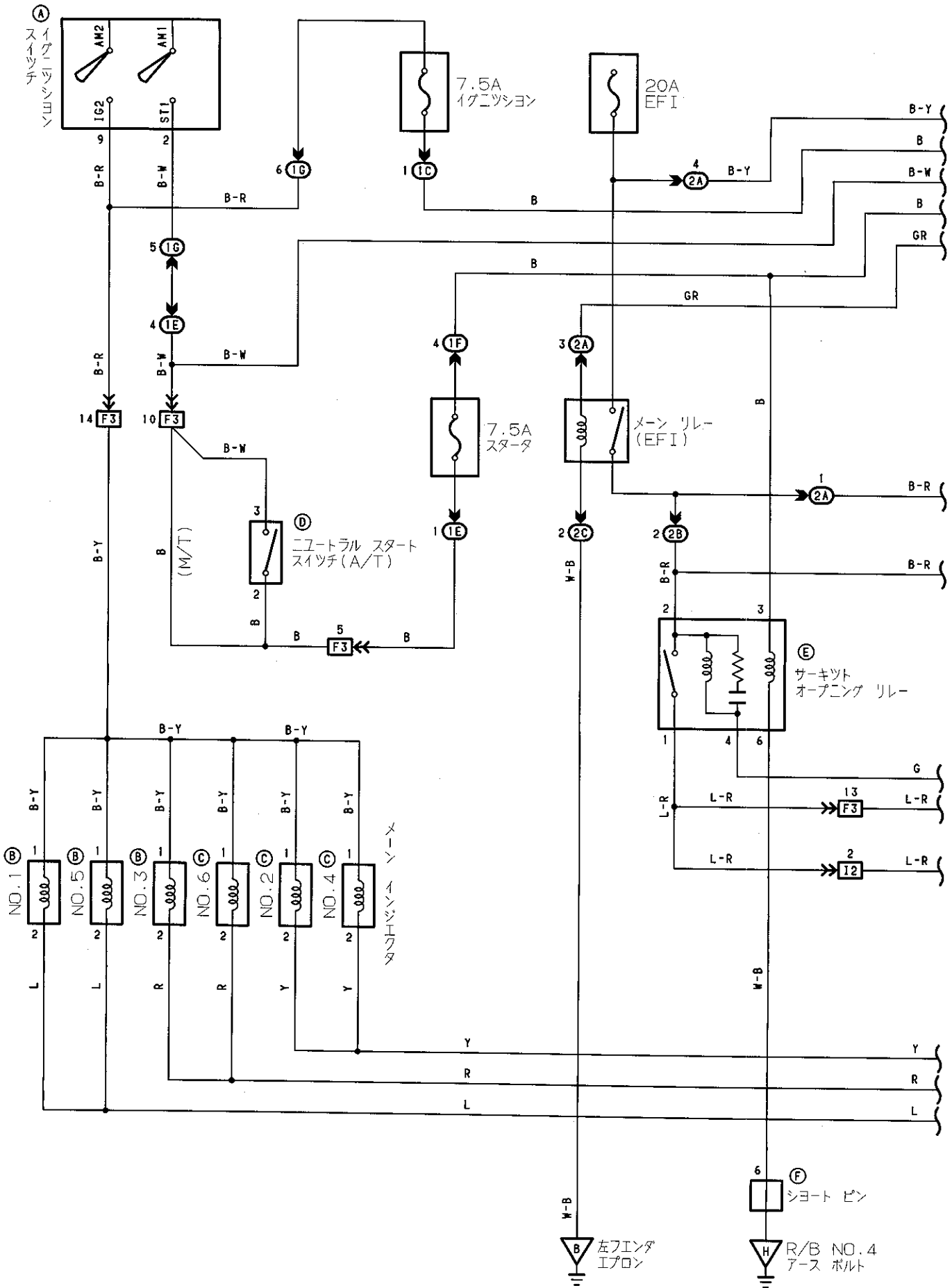

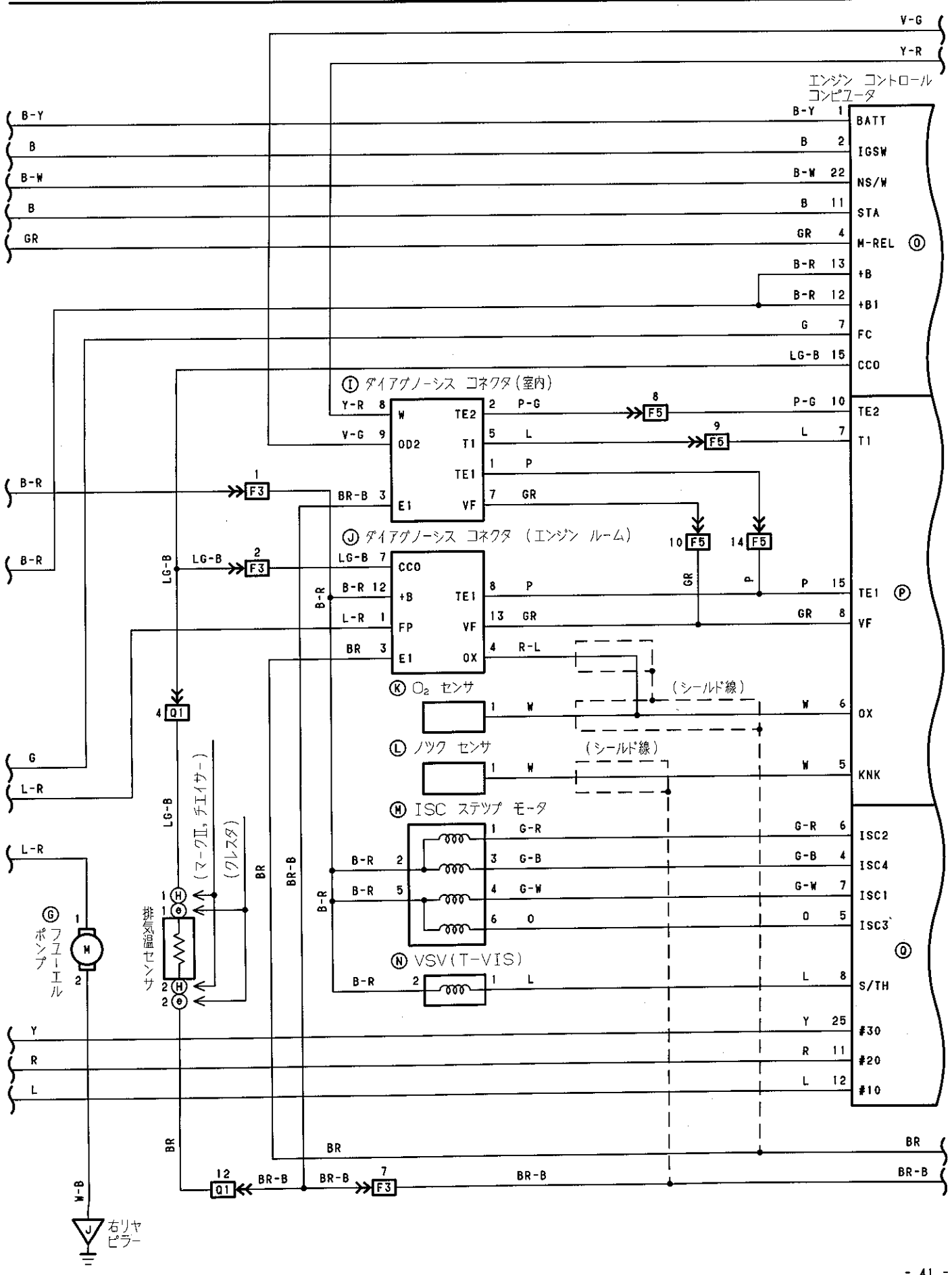

EFI (1G-GE)

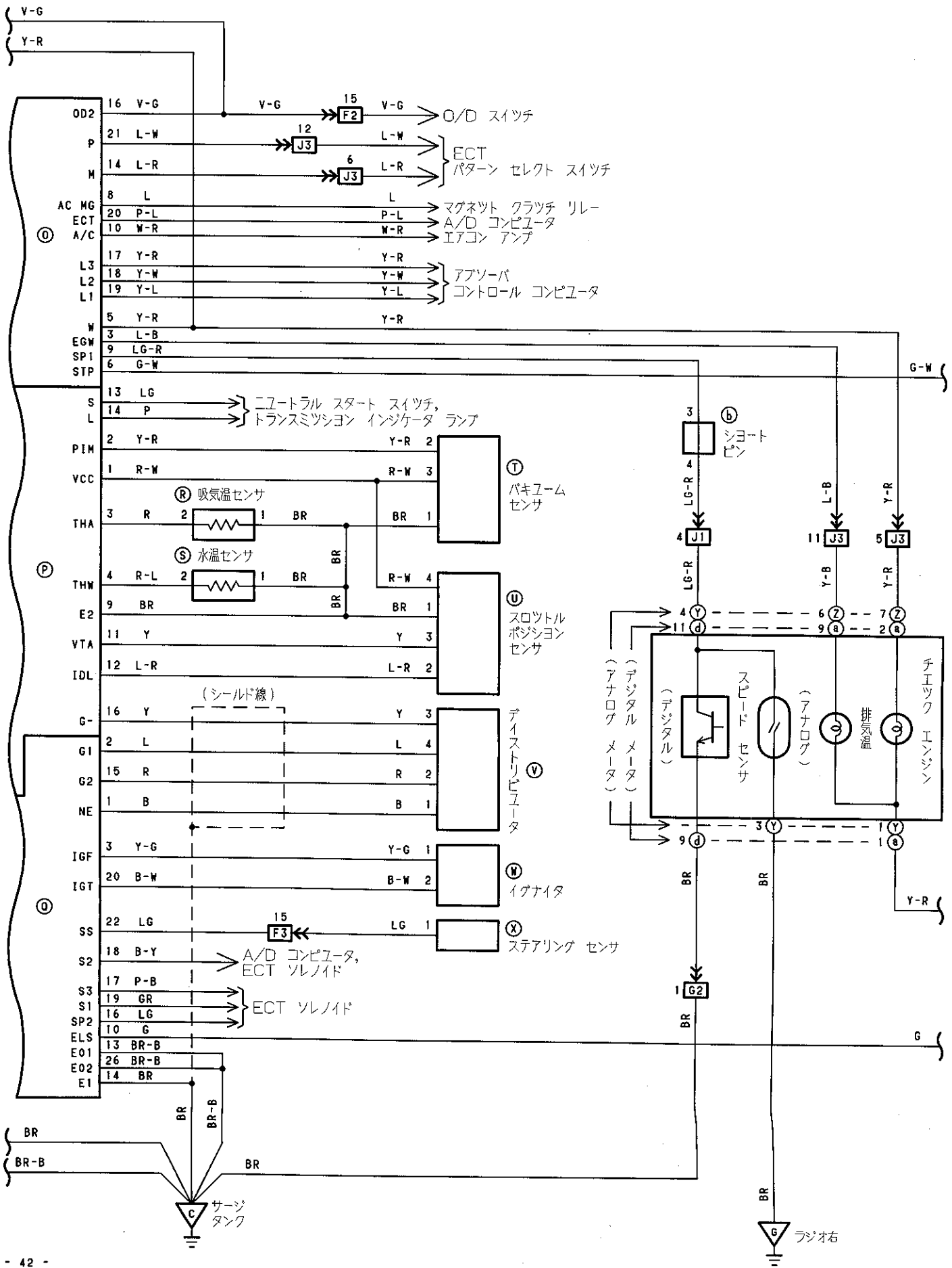

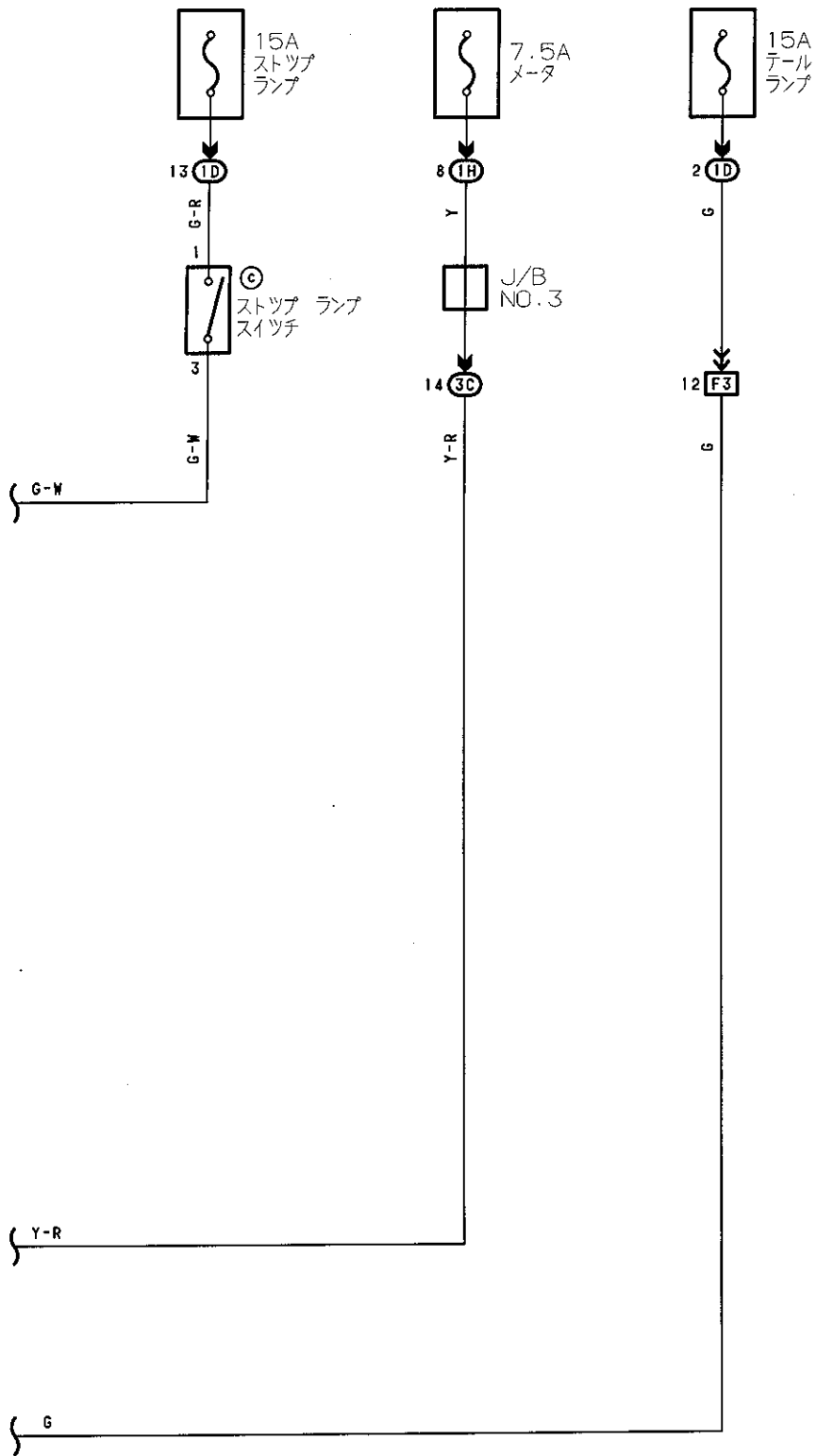

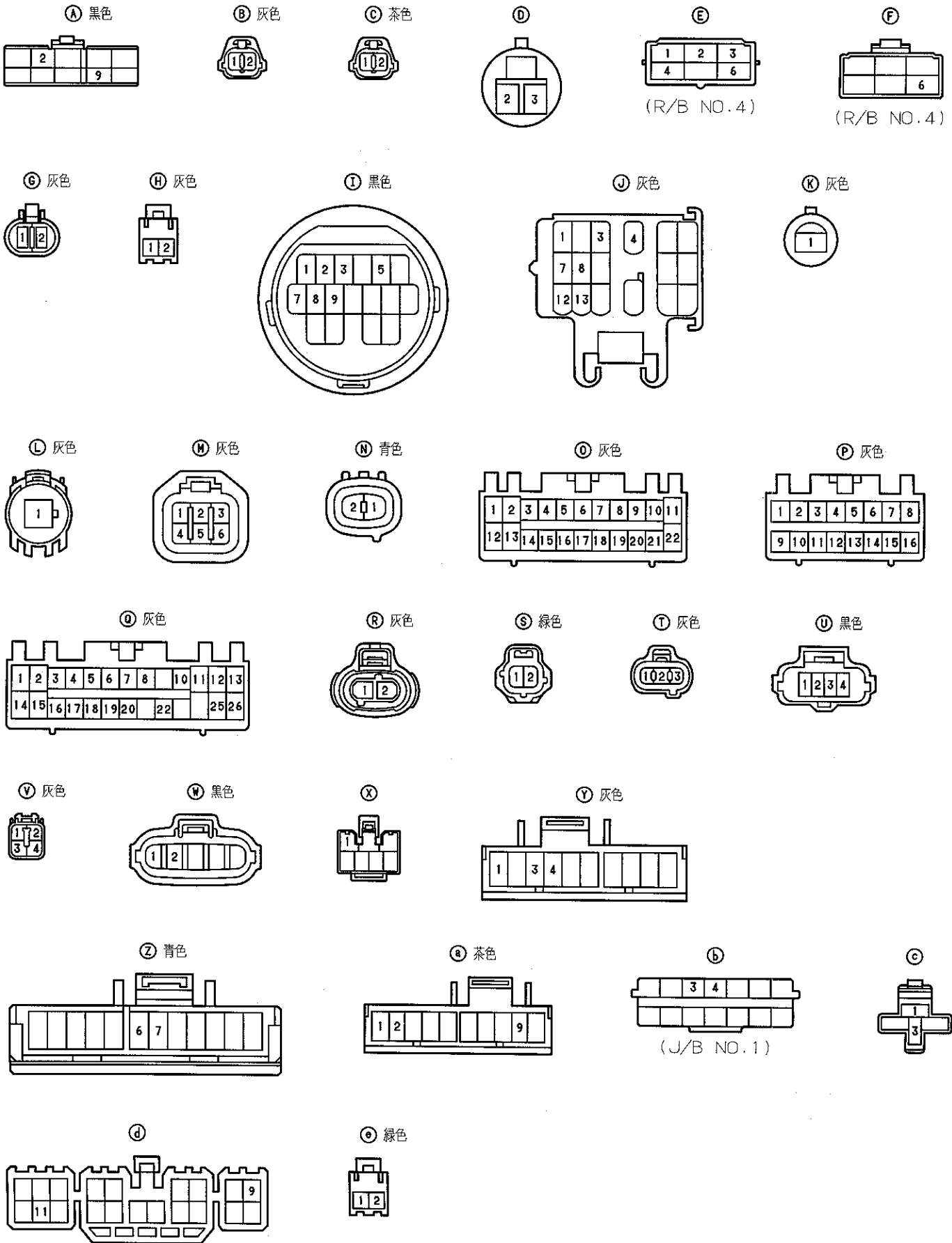

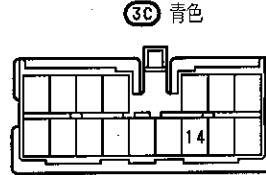
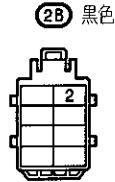
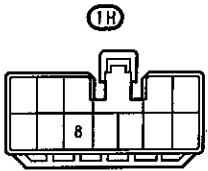
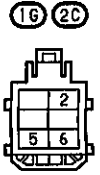
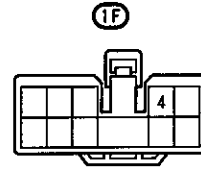
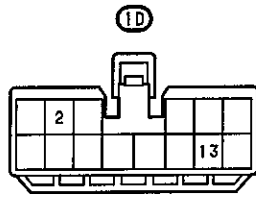
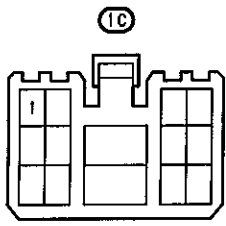

F2 黄色

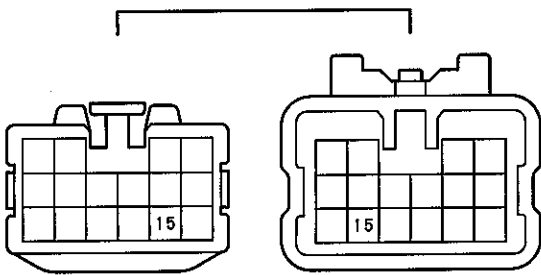

F3 灰色

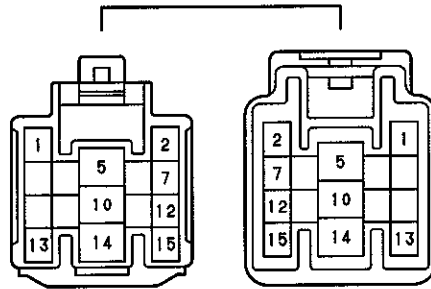

F5 灰色

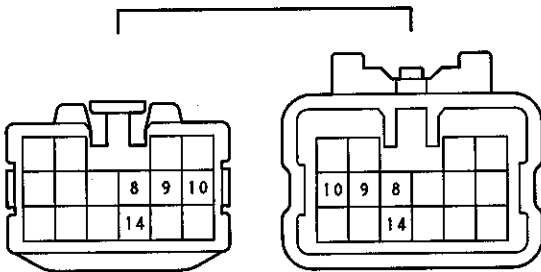

G2

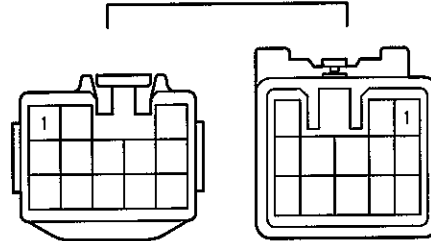

I2

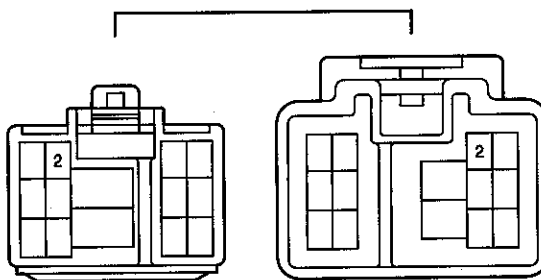

J1 J3

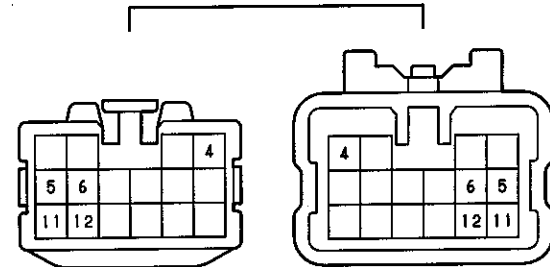

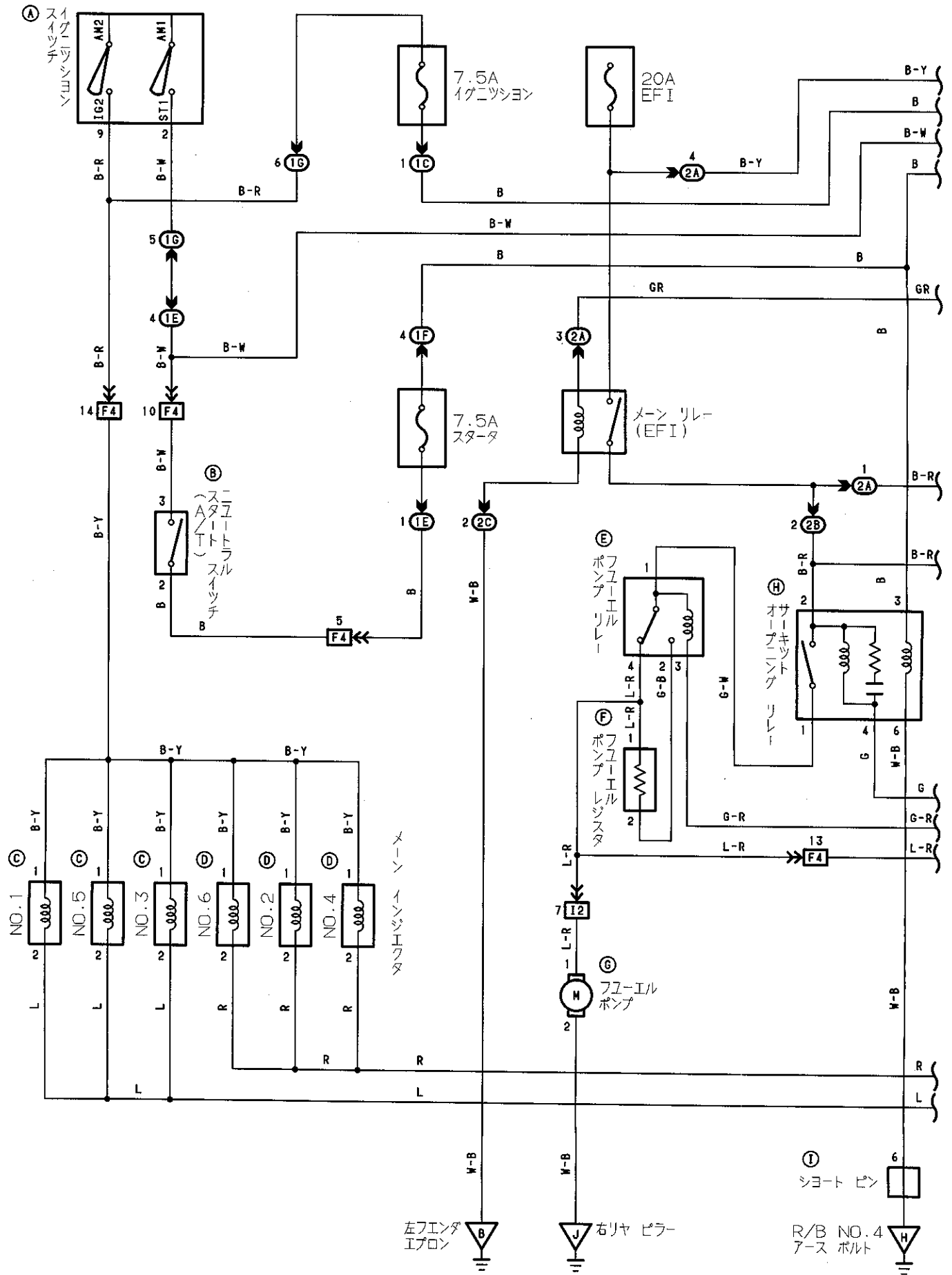

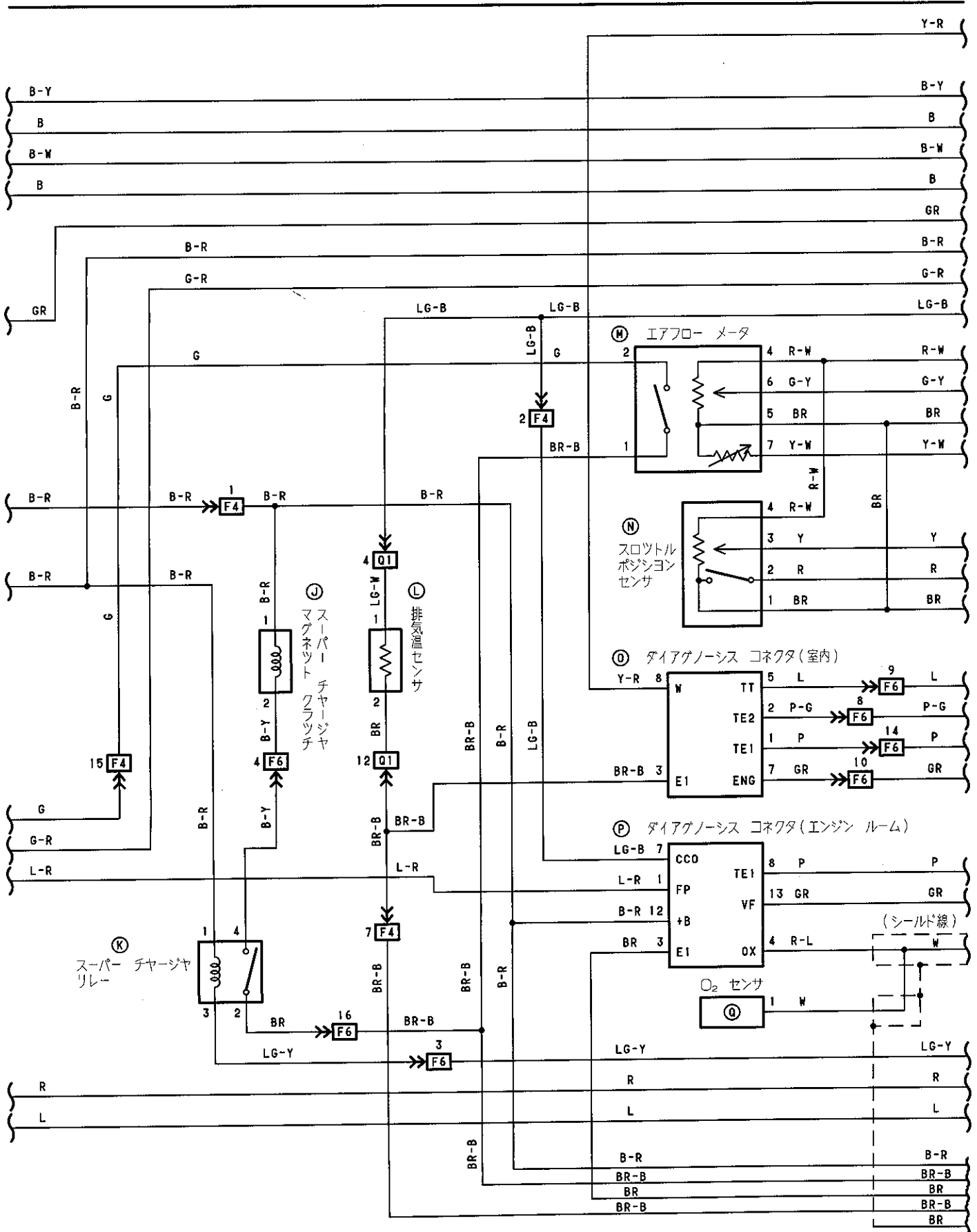



EFI (1G-GZE)

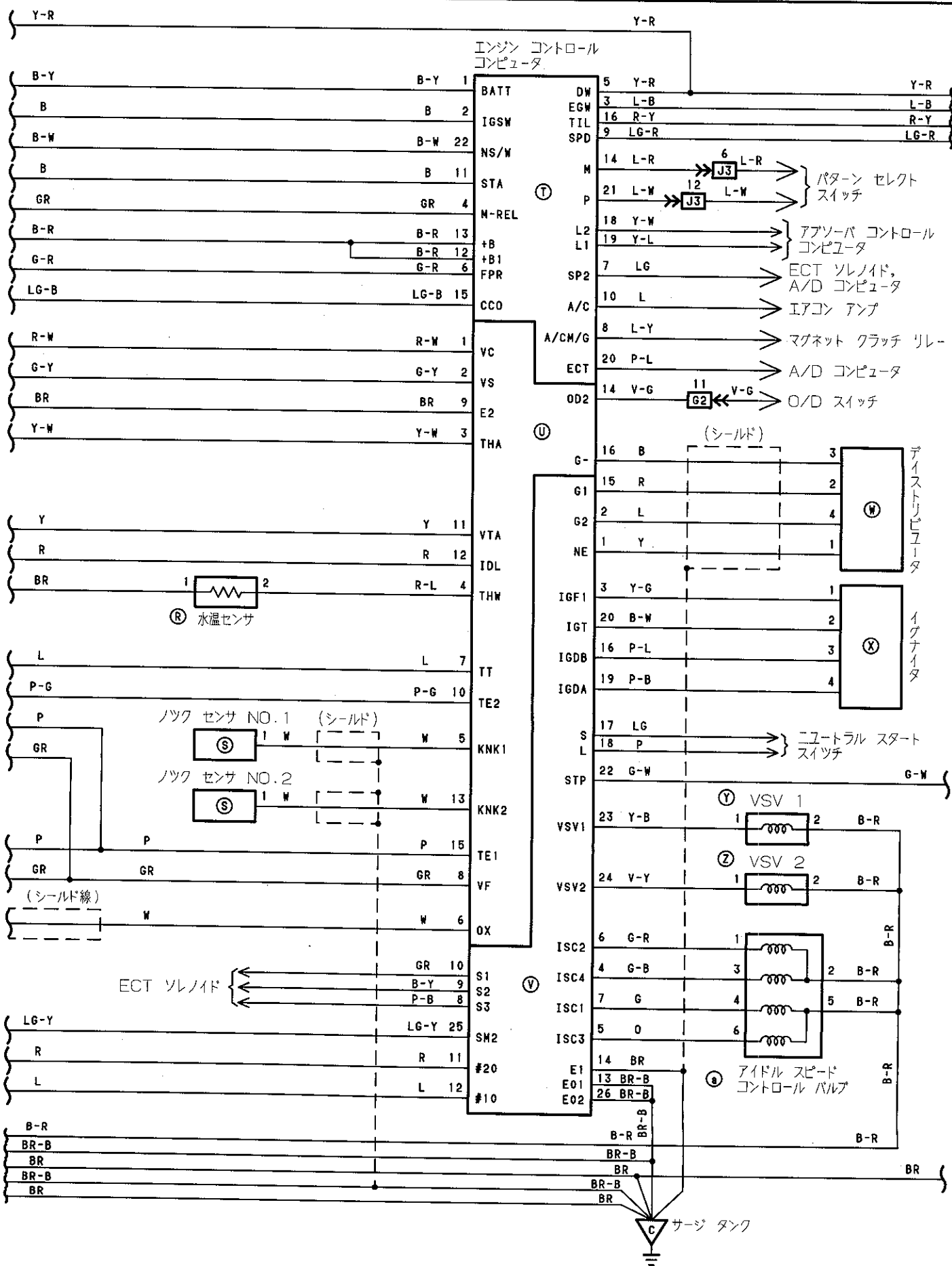

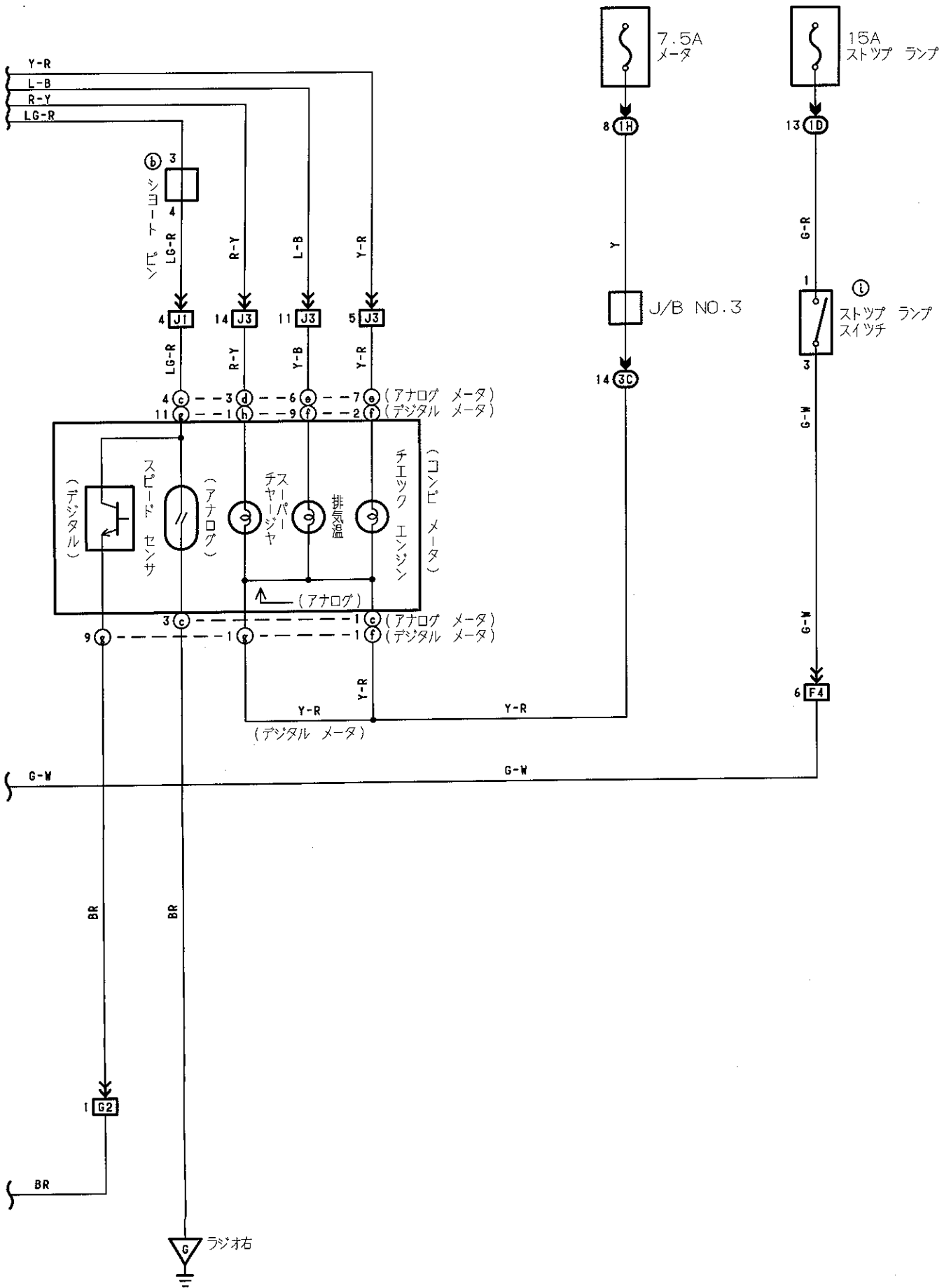



EFI (1G-GZE)

Ⓐ 黒色



Ⓑ

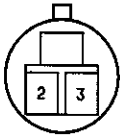

Ⓒ 灰色



Ⓓ 茶色



Ⓔ

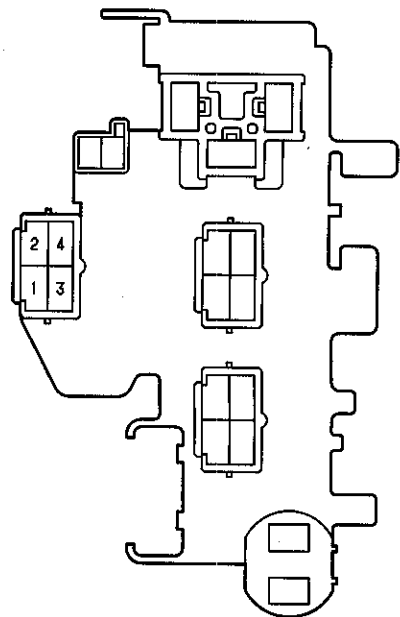

(J/B NO.1 カセット)

Ⓕ 灰色



Ⓖ 灰色



Ⓗ

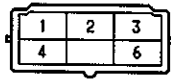

(R/B NO.4)

Ⓘ

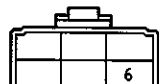

(R/B NO.4)

Ⓙ 灰色

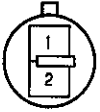

Ⓚ 灰色



Ⓛ 灰色

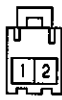

(マークII, チエイサー)

Ⓛ 緑色

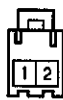

(クレスト)

Ⓜ 黒色

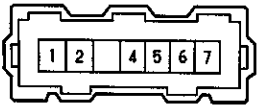

Ⓝ 黒色



Ⓣ 黒色

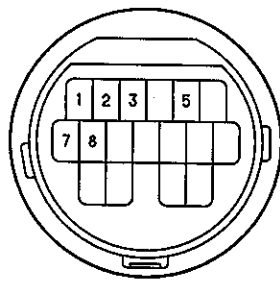

Ⓟ 灰色

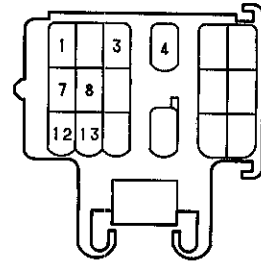

Ⓡ 灰色



Ⓡ 緑色



Ⓢ 灰色



Ⓣ 灰色

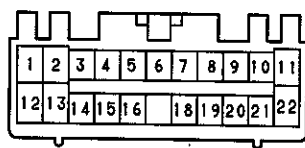

Ⓤ 灰色

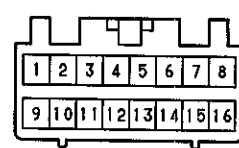

Ⓥ 灰色

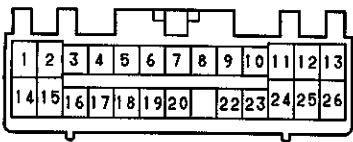

Ⓜ X 灰色



Ⓨ 茶色



Ⓩ 青色



Ⓚ 灰色



Ⓛ

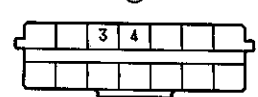

(J/B NO.1)

ⓐ 灰色

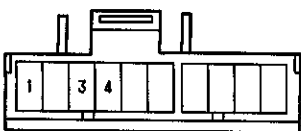

ⓓ ⓕ 茶色

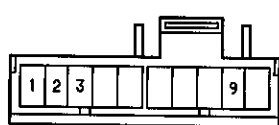

ⓖ 青色

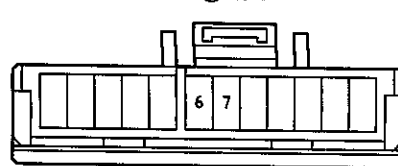

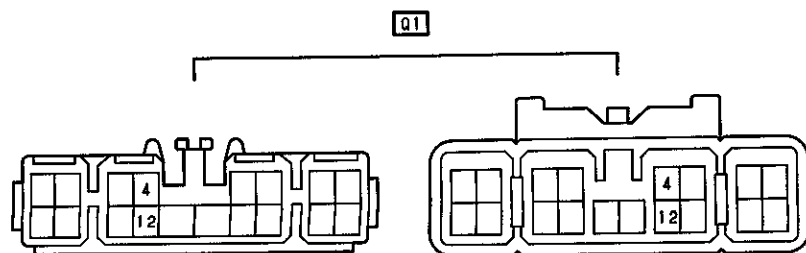
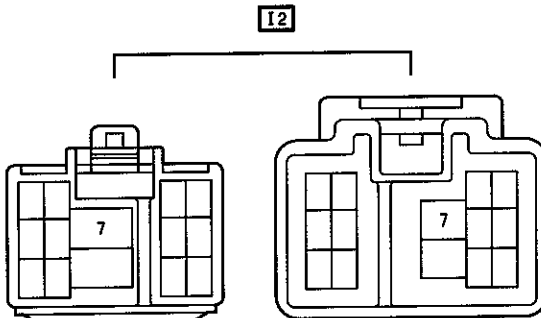
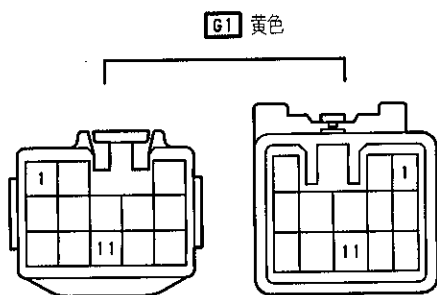
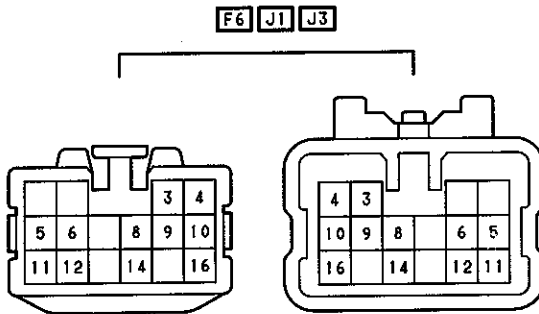
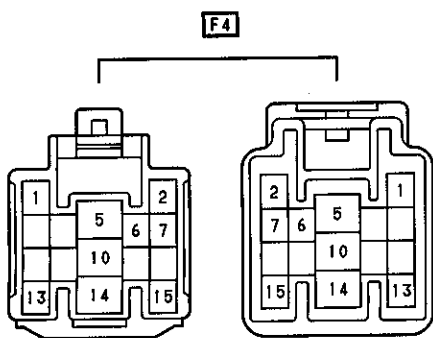
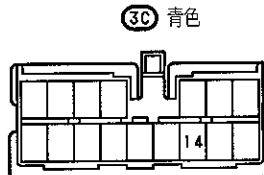
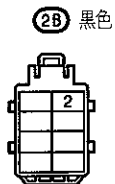
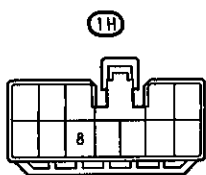
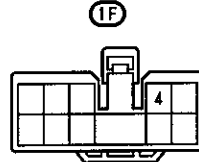
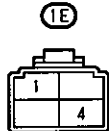
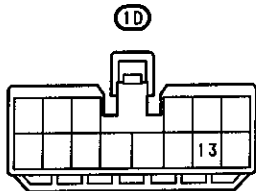
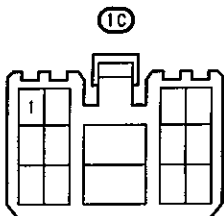
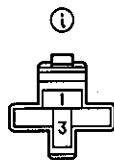
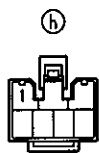
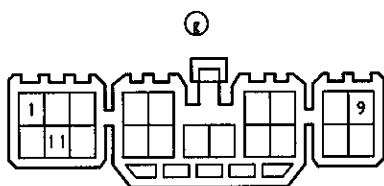



EFI (1G-GTE)

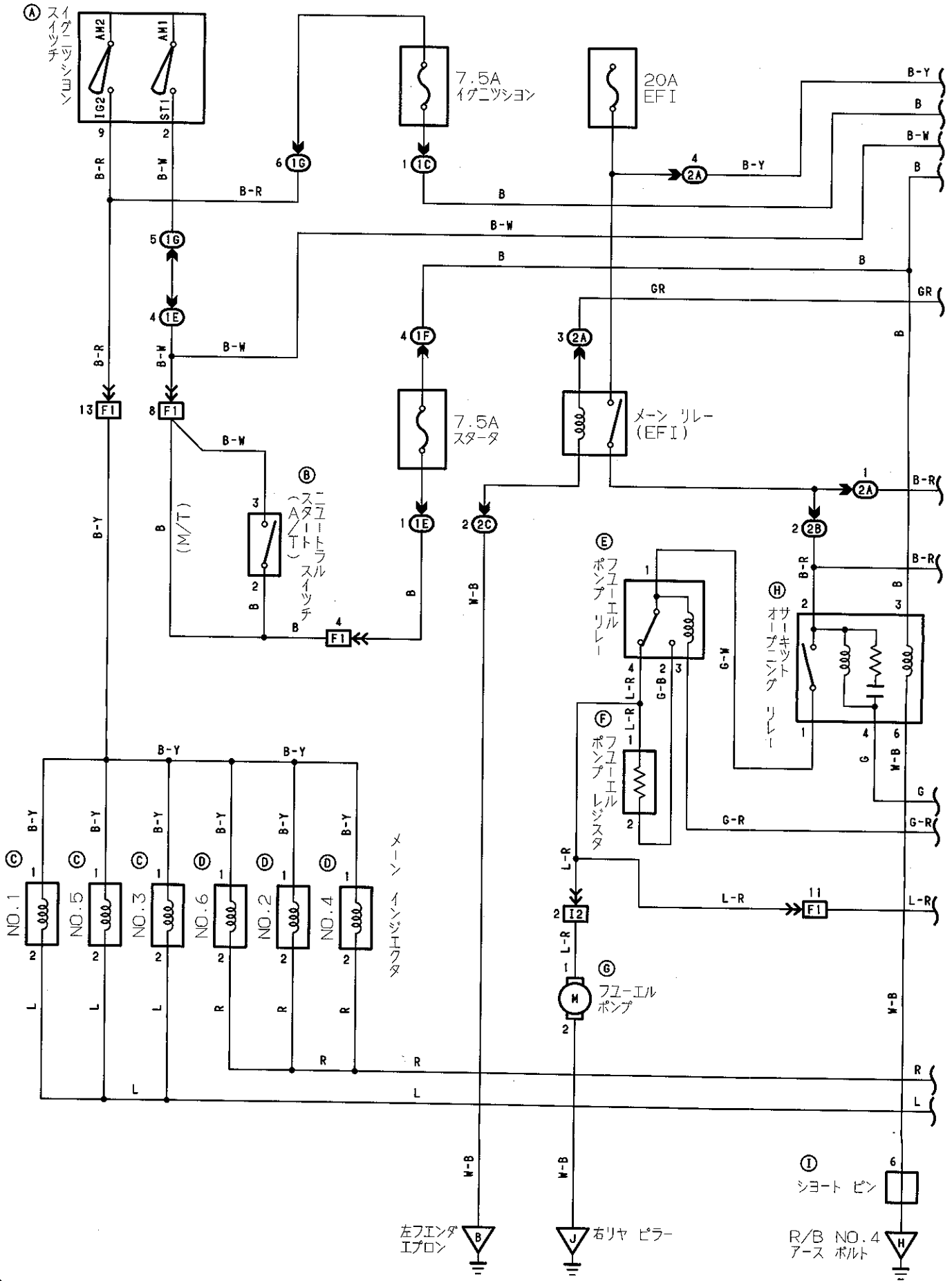

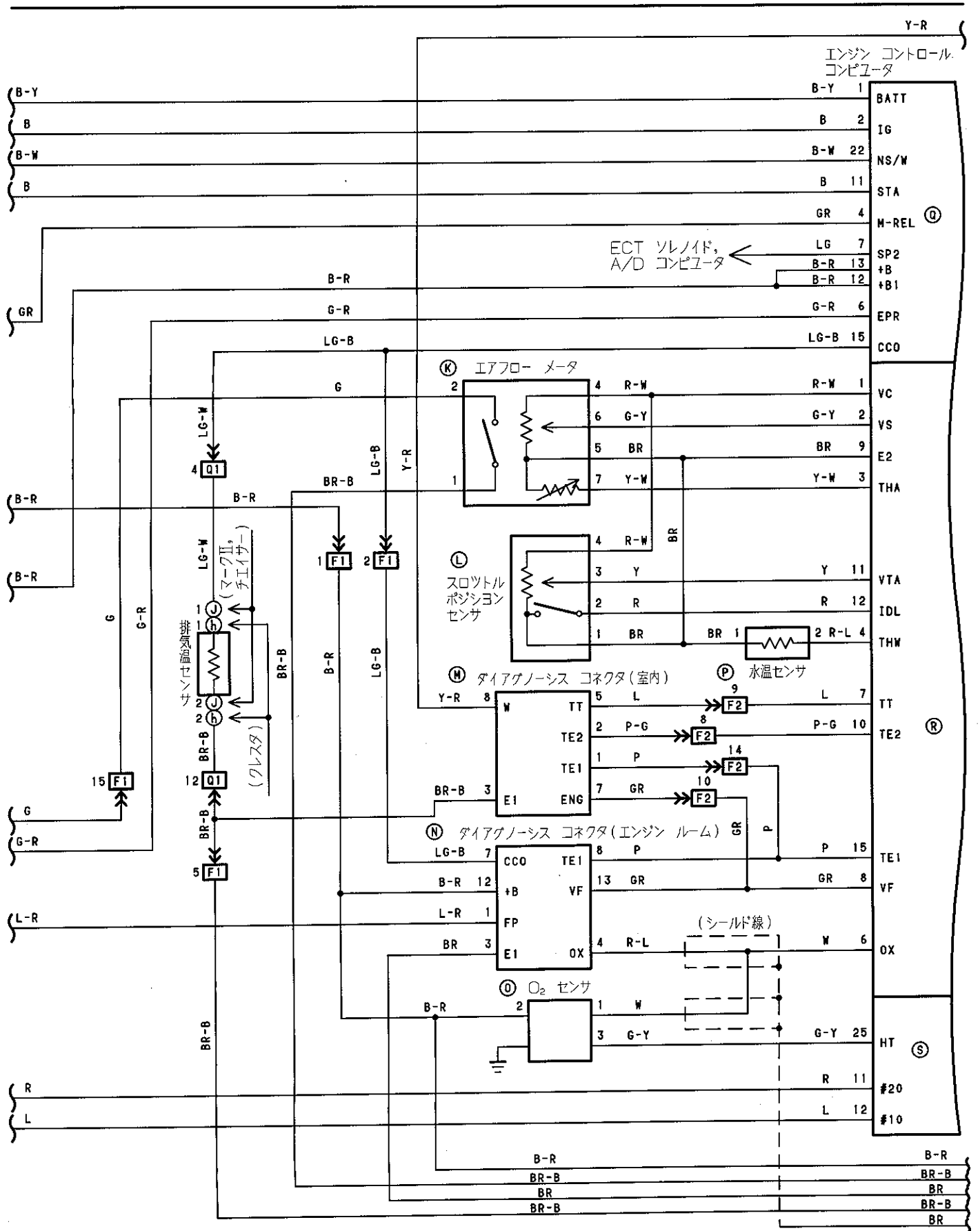



EFI (1G-GTE)

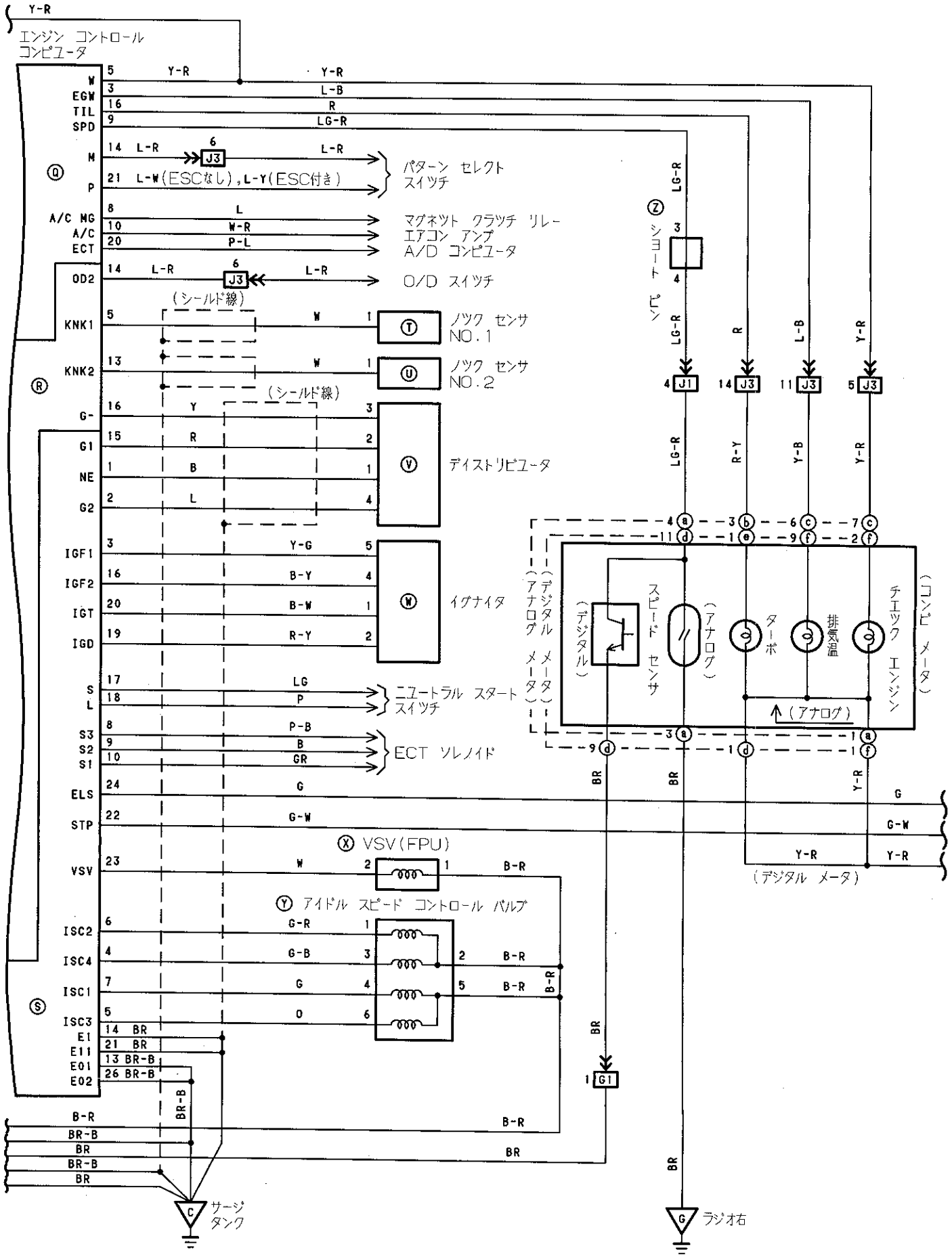

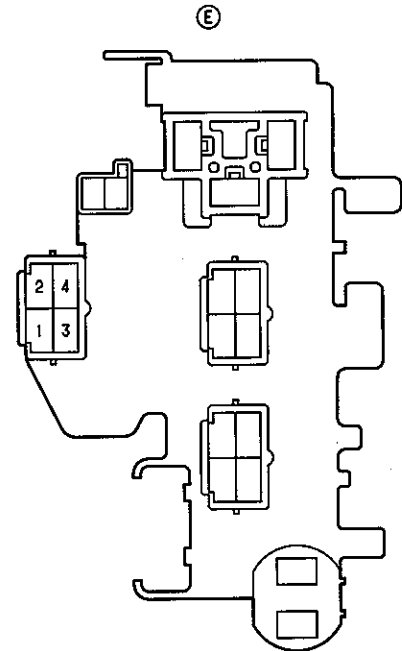
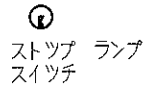
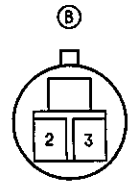
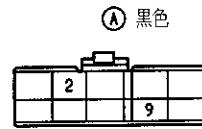
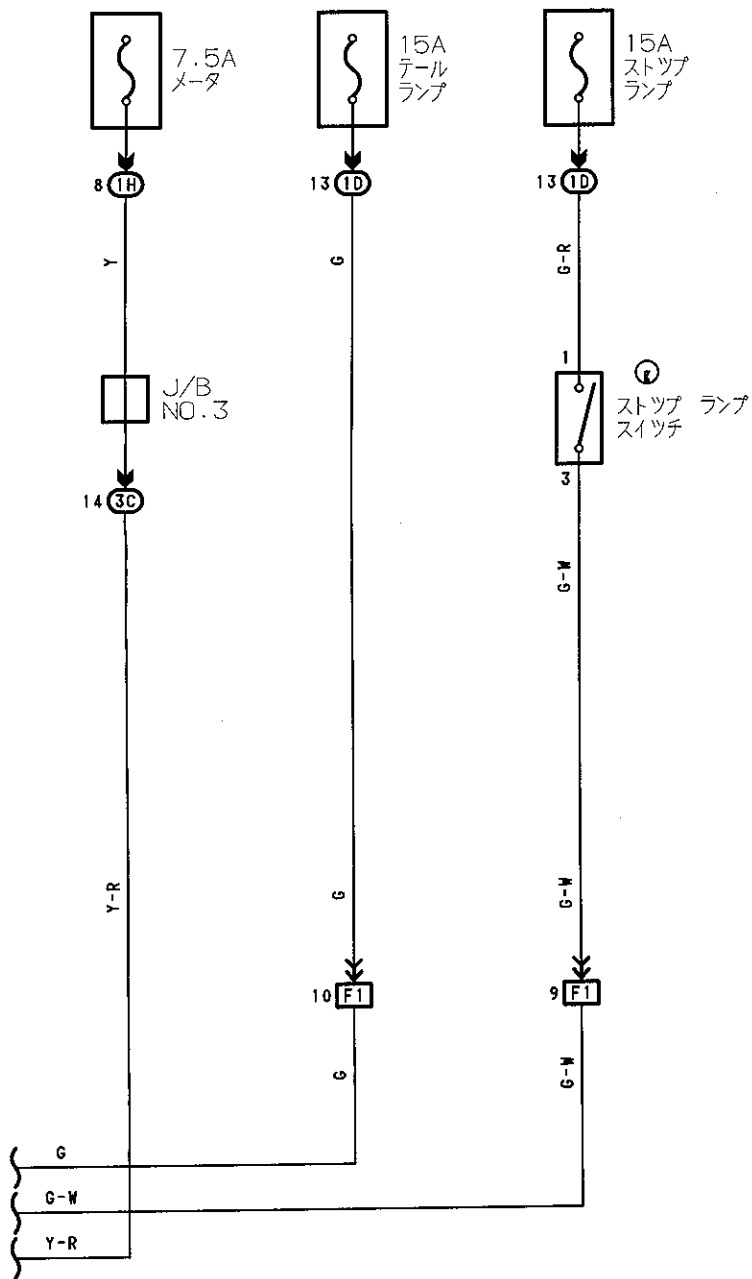

(J/B NO. 1)

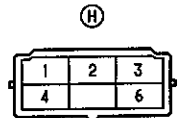

(R/B NO. 4)

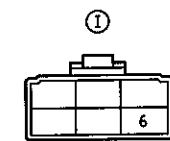

(R/B NO. 4)

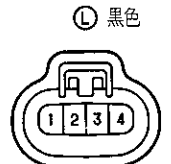
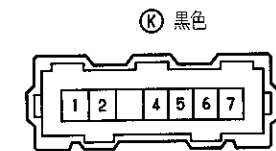

Ⓜ 黑色

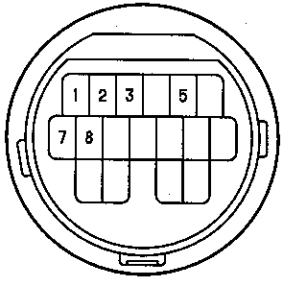

Ⓝ 灰色

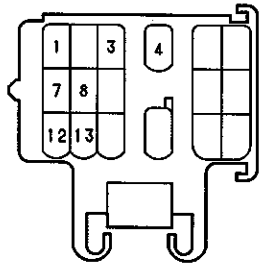

ⓐ 灰色



Ⓟ 綠色



ⓑ 灰色

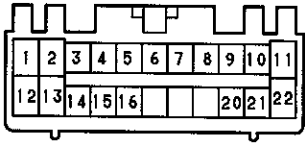

Ⓡ 灰色

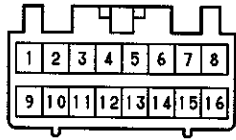

Ⓢ 灰色

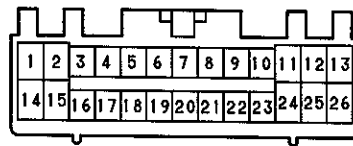

Ⓣ Ⓤ 灰色



Ⓥ 灰色



Ⓦ 灰色

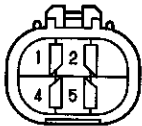

Ⓧ 青色



Ⓨ 灰色

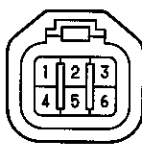

Ⓩ

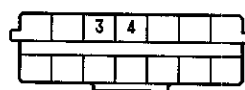

(J/B NO. 1)

ⓐ 灰色

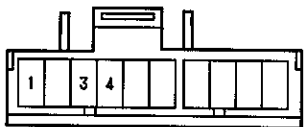

Ⓡ Ⓣ 茶色

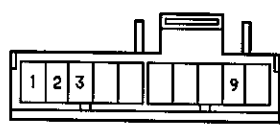

Ⓒ 青色

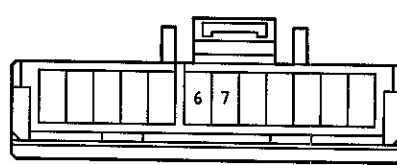

ⓓ

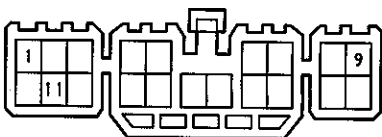

ⓔ

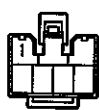

ⓕ



ⓗ 綠色



Ⓢ

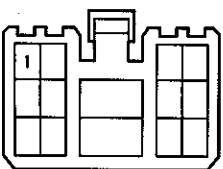

ⓓ

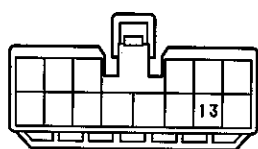

ⓓ



ⓓ

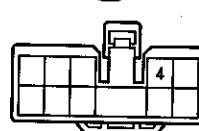

ⓓ Ⓢ

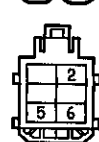

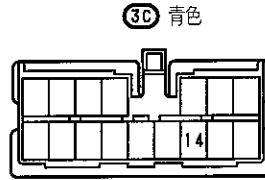
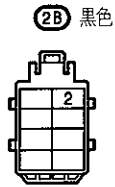
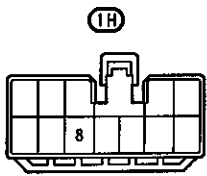

F1 黄色

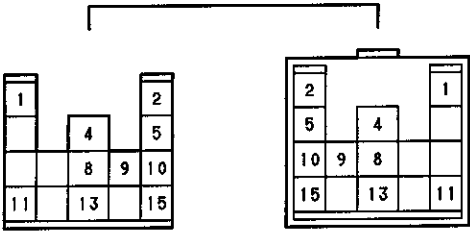

F2 黄色

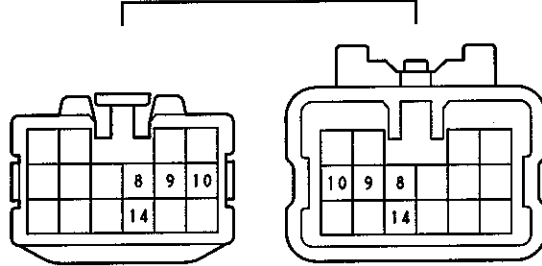

G1 黄色

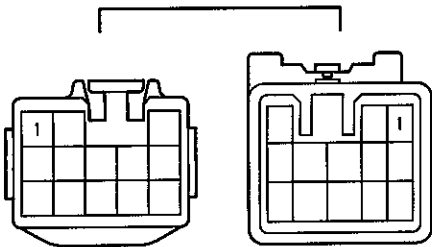

I2

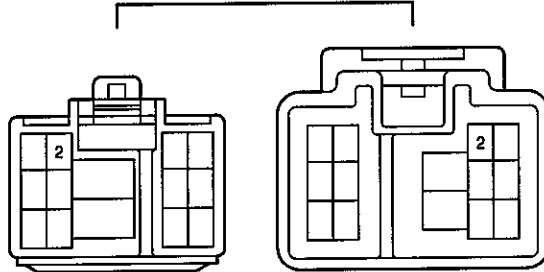

J1 J3

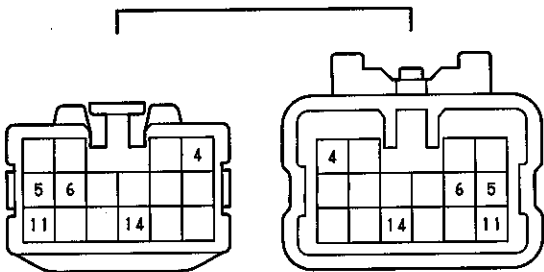

Q1

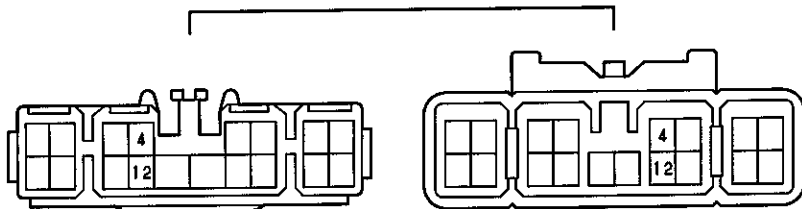

EGR (2L, 2L-T)

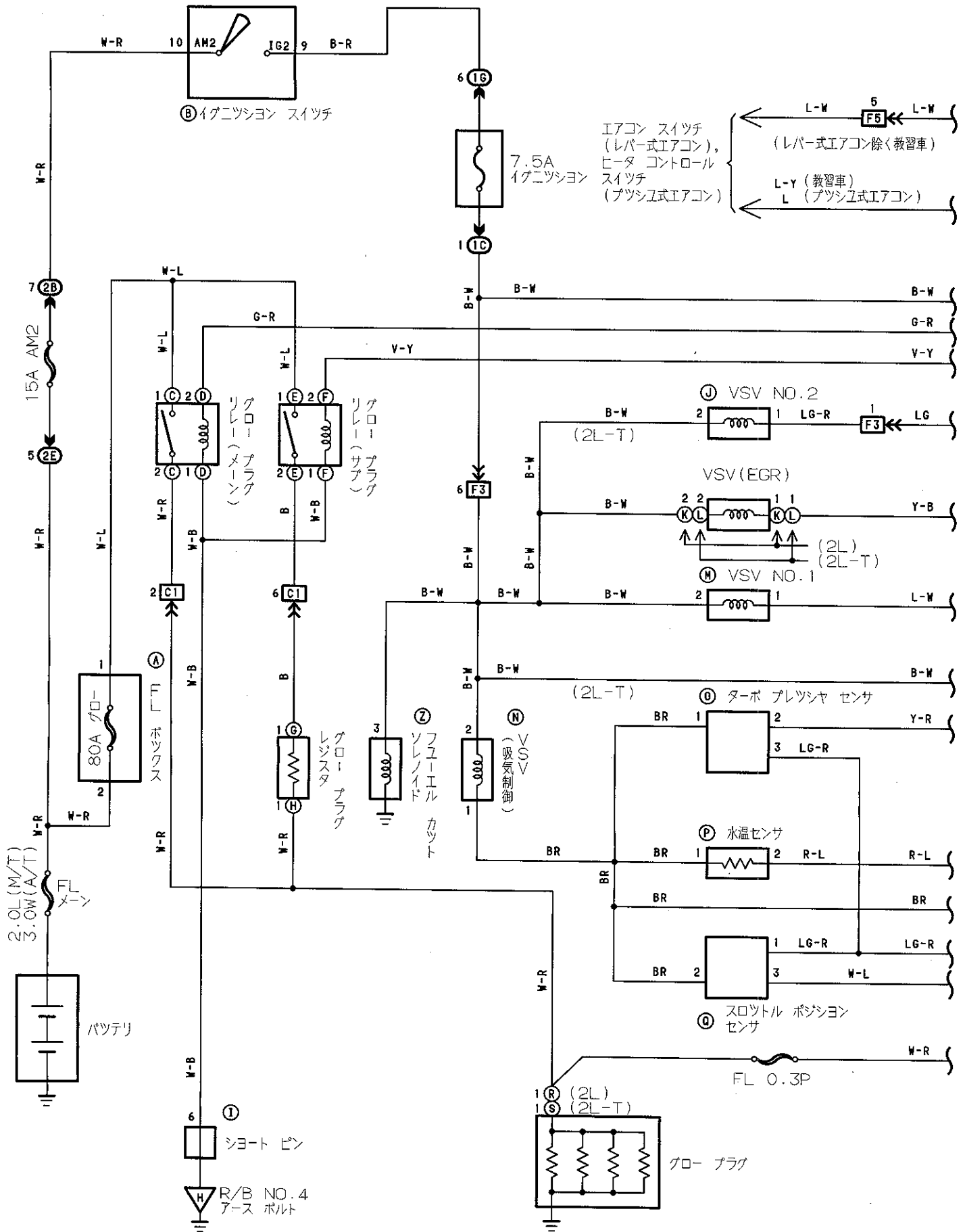

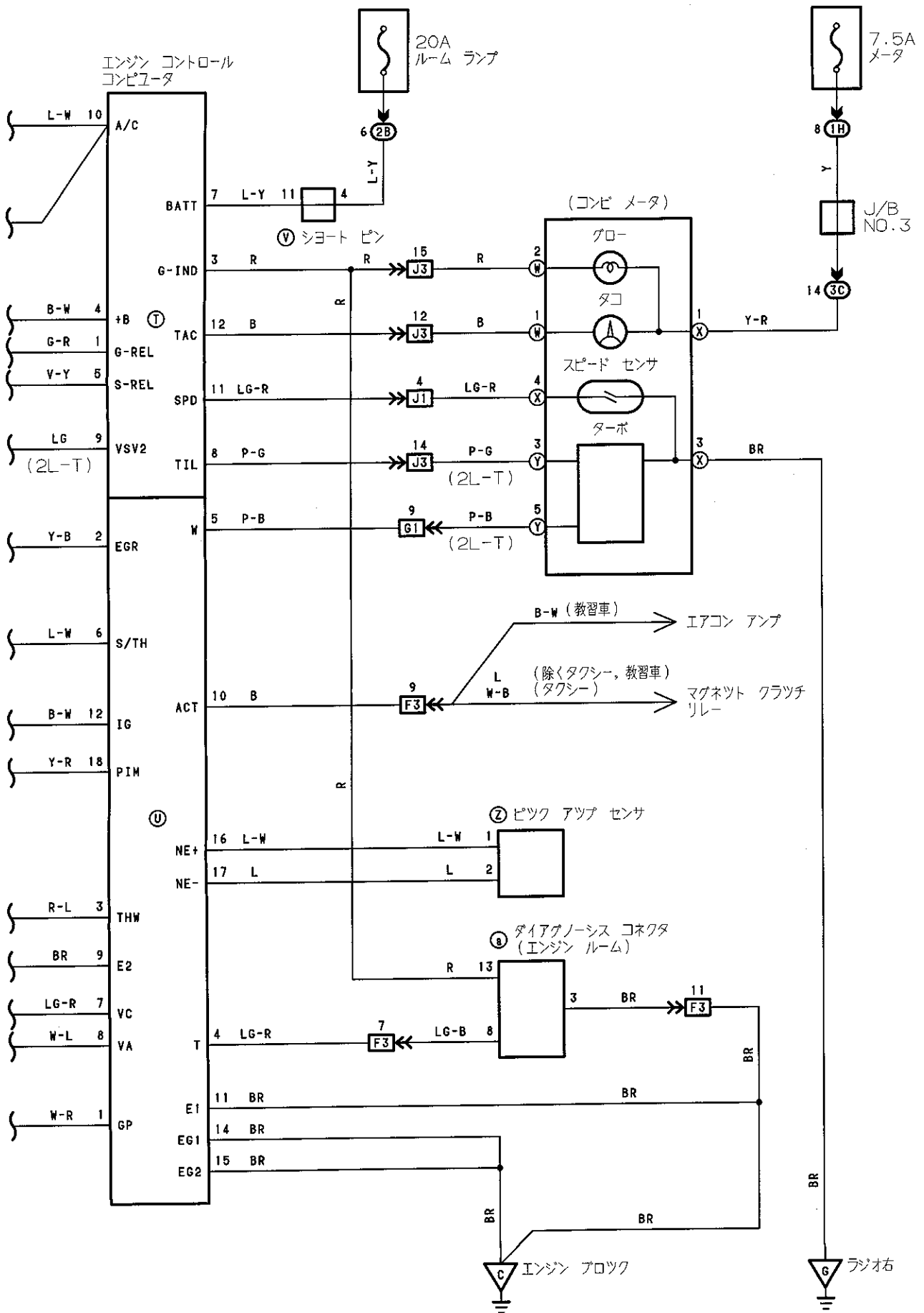

EGR EGR(2L, 2L-T)

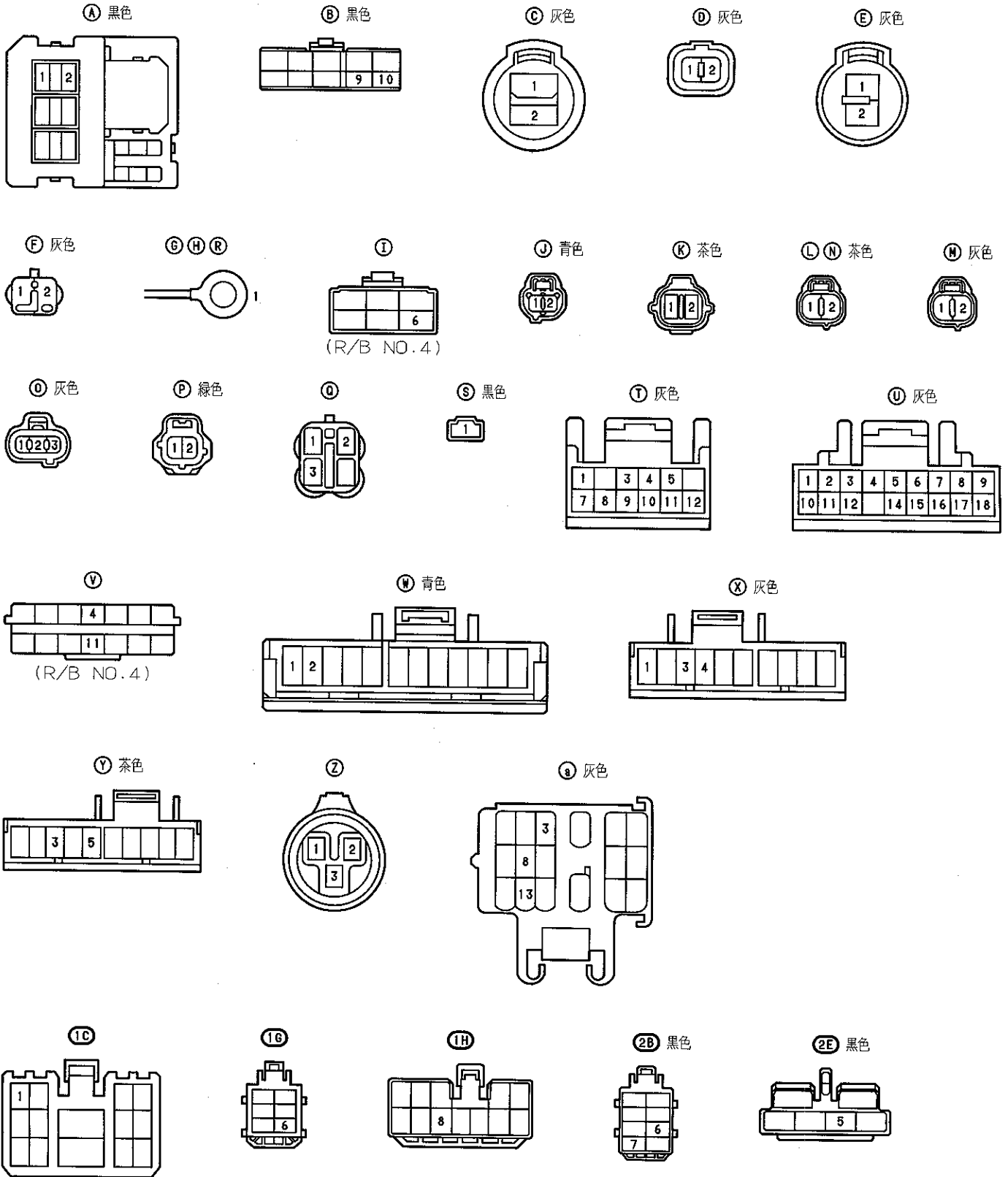

3C 青色

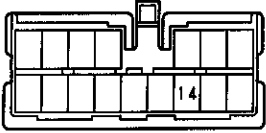

C1 黑色

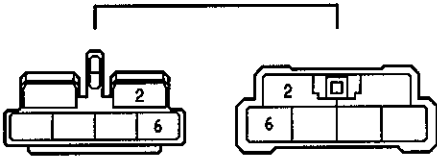

F3 灰色

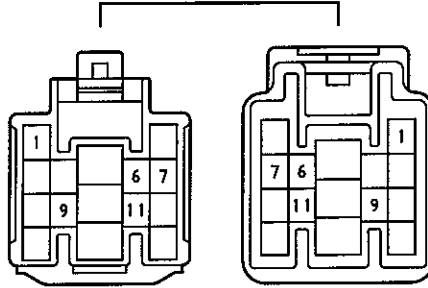

F5 灰色

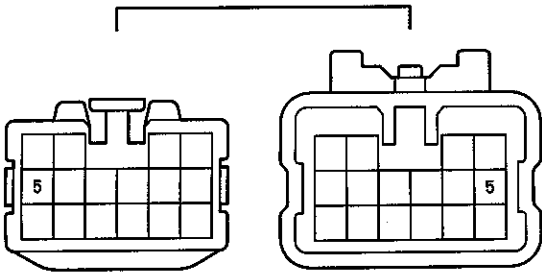

G1 黄色

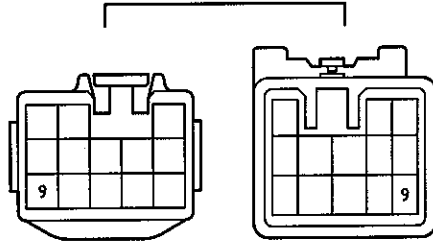

J1 J3

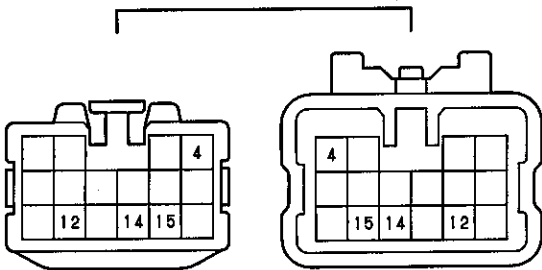



排出ガス浄化装置 (3Y-P)

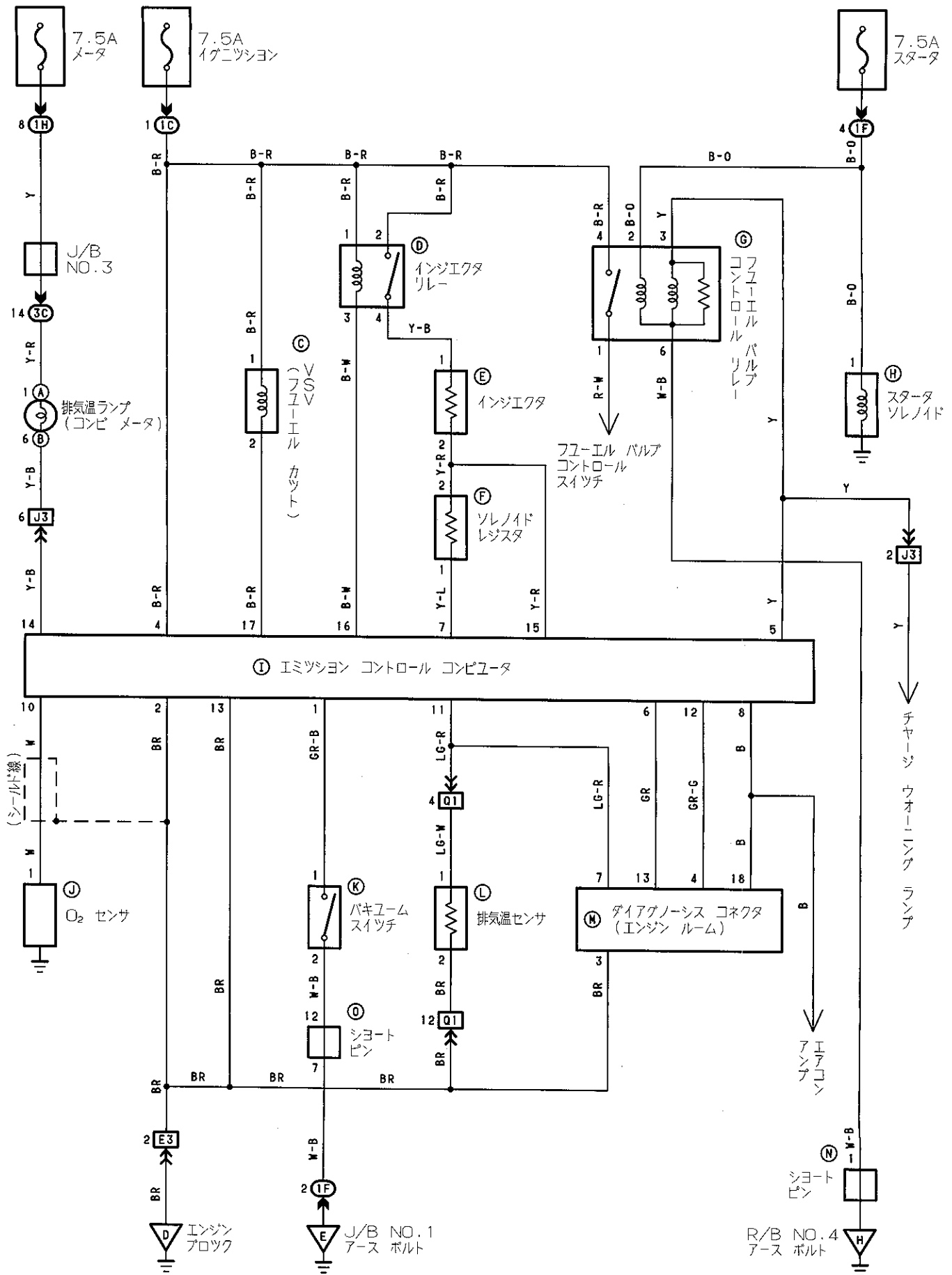

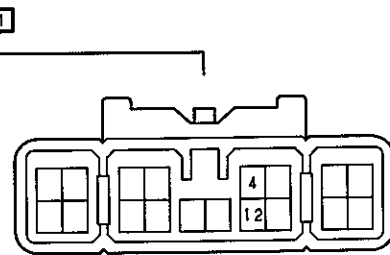
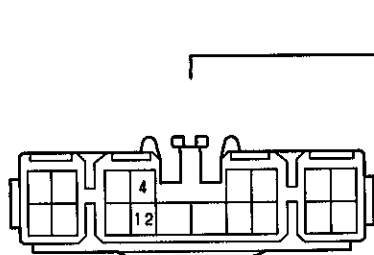
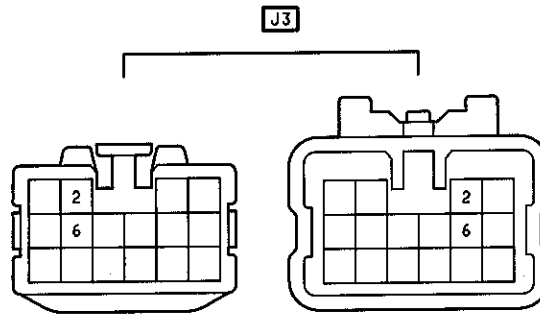
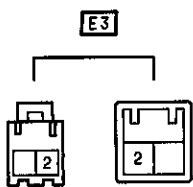
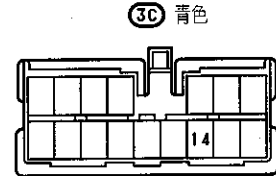
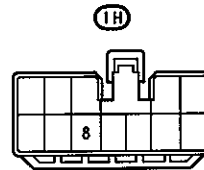
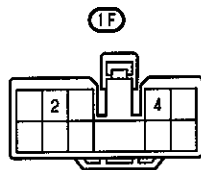
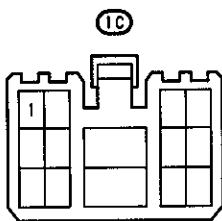
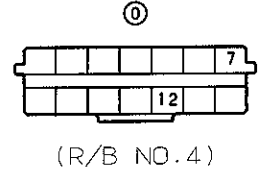
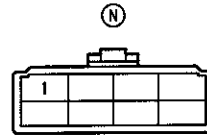
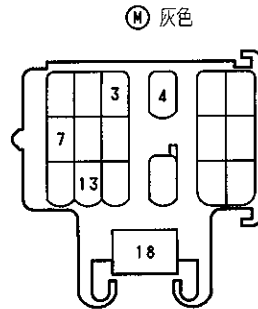
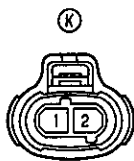
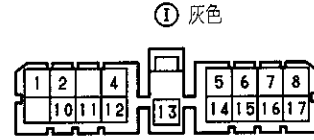
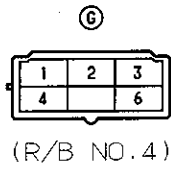
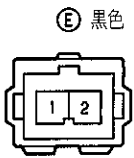
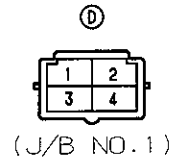
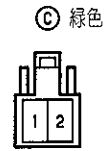
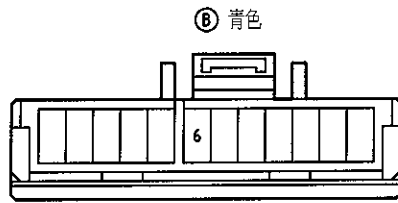
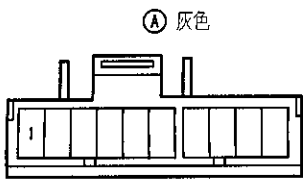



フューエル ヒータ

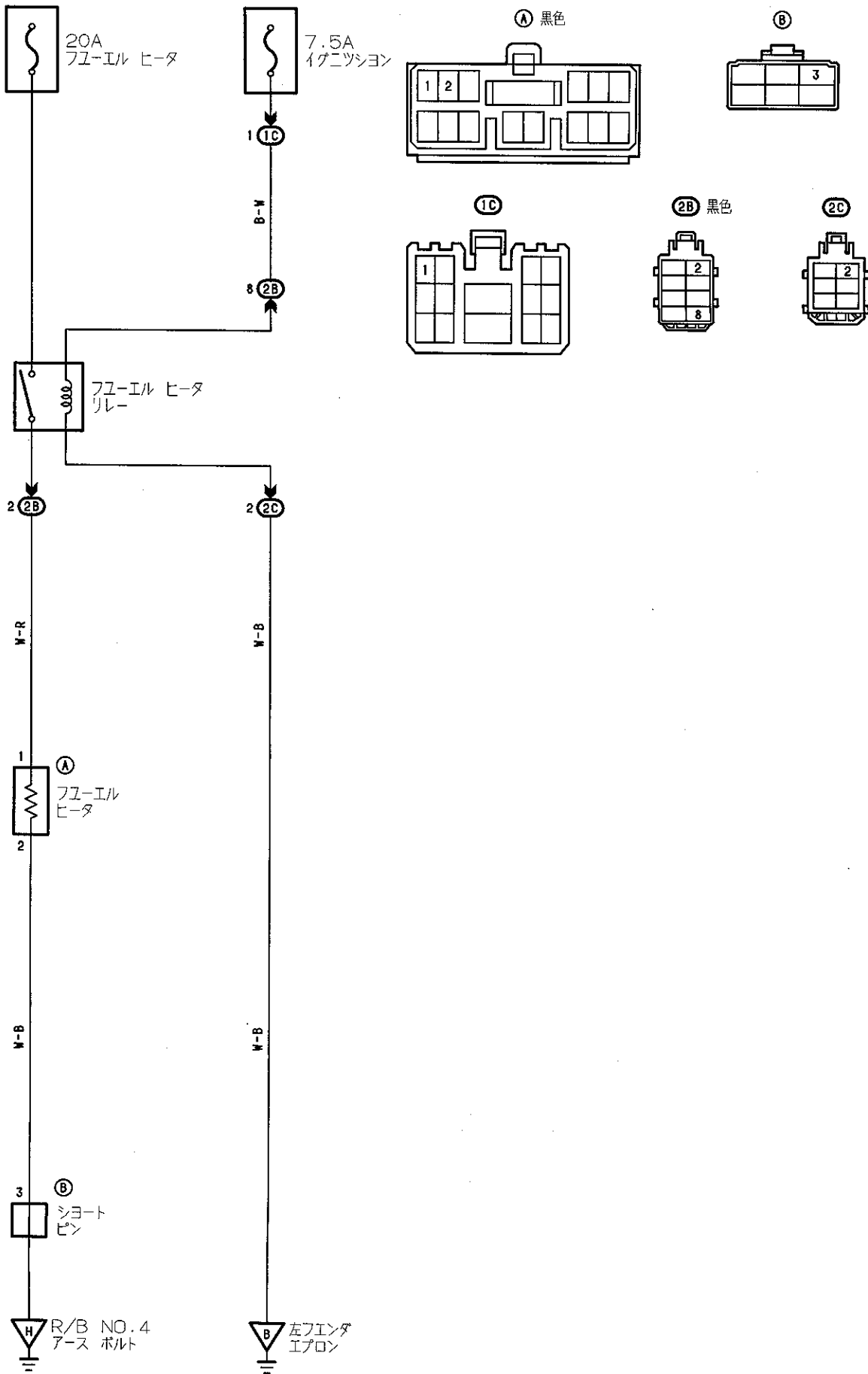

キャブレター (3Y-P)

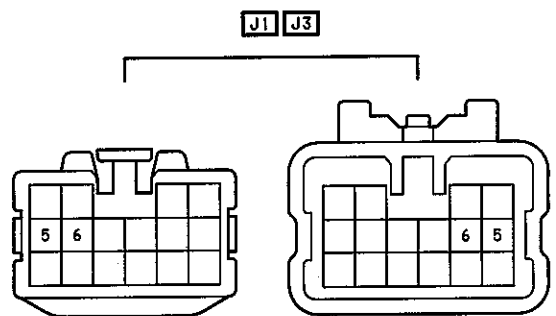
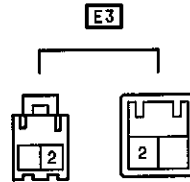
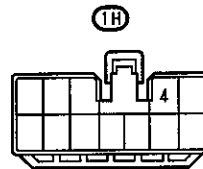
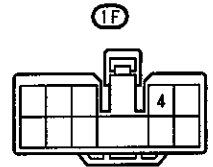
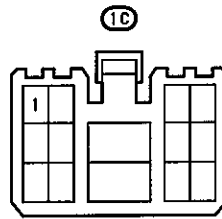
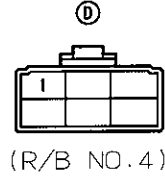
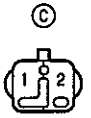
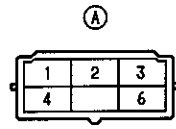
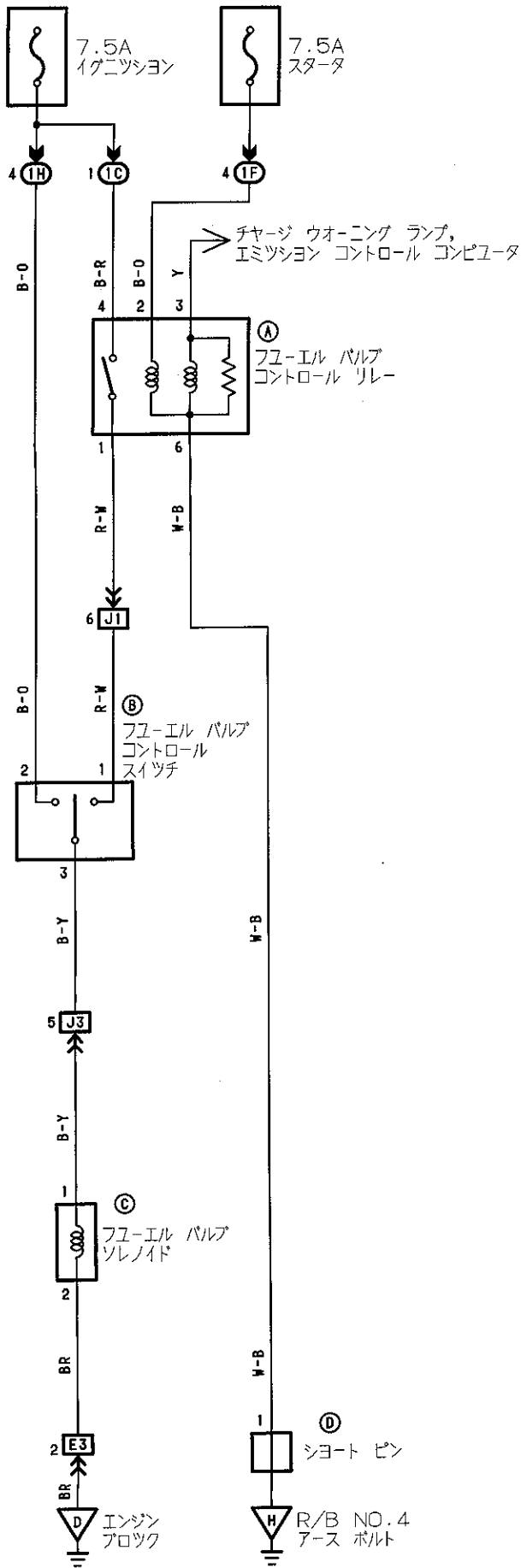



ヘッドランプ

○ 1G-FE ESCなし
 △ 1G-FE ESC付き

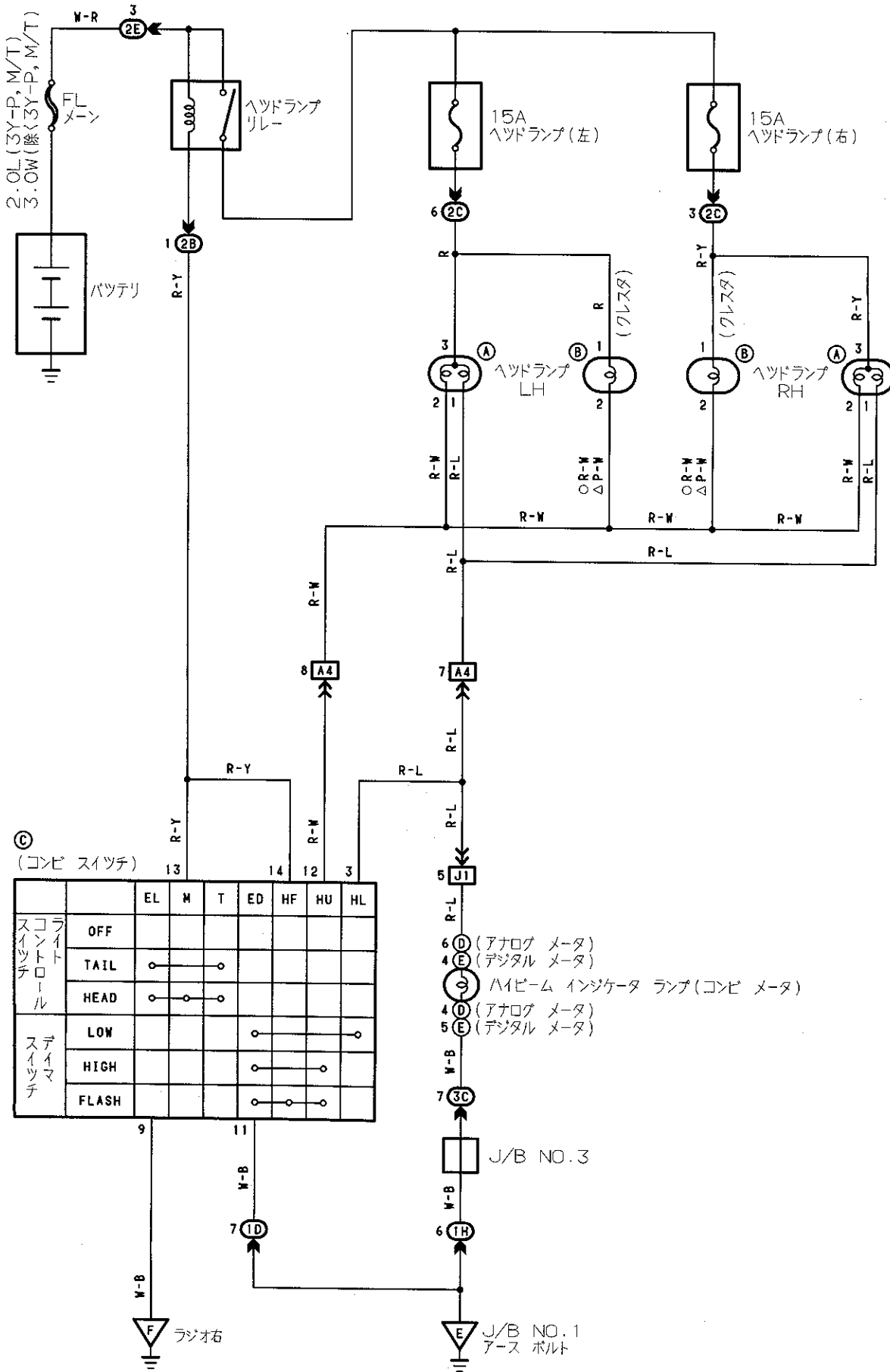

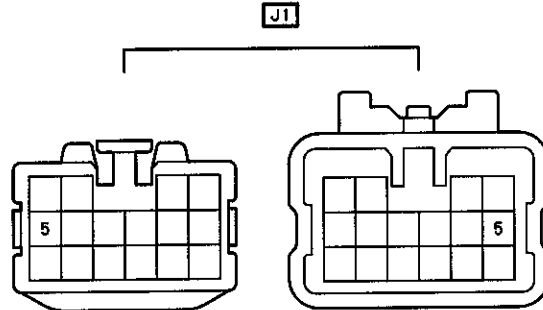
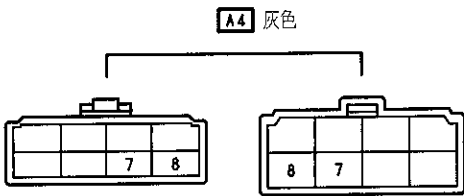
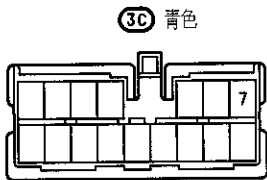
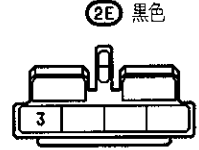
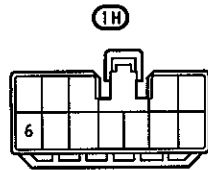
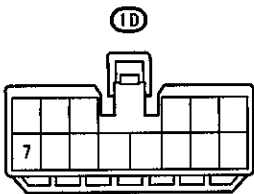
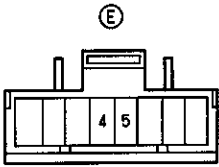
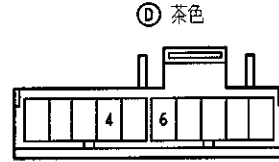
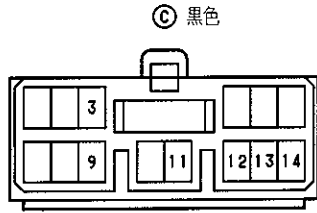
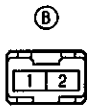
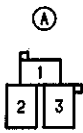

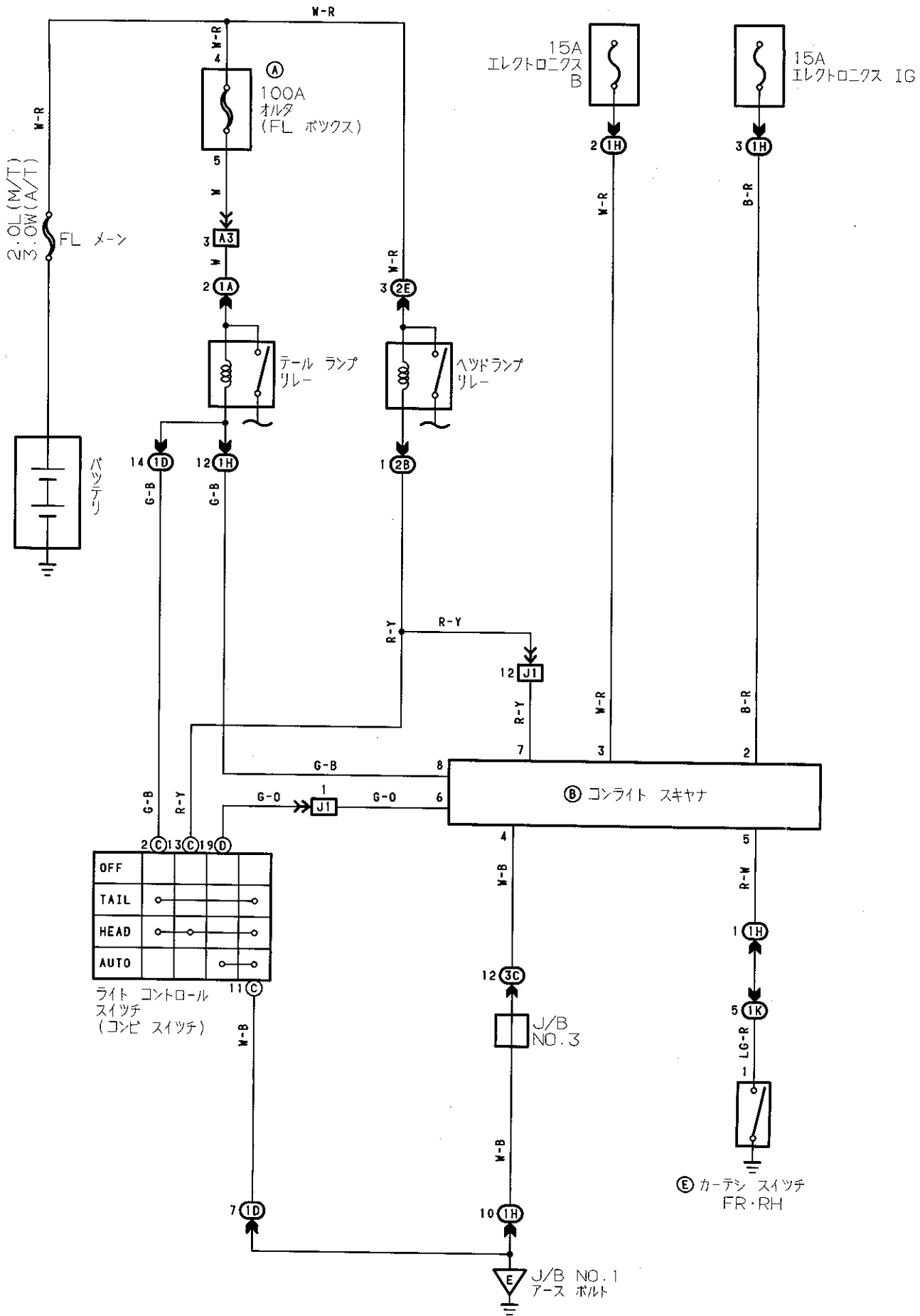

① 黑色

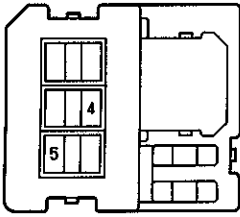

②



③ 黑色

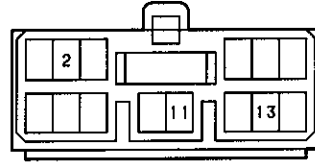

④ 黑色

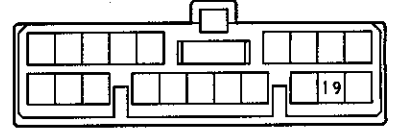

⑤



①A ②E 黑色

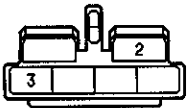

⑩D

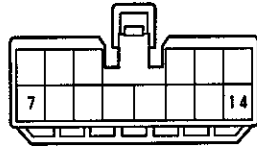

⑩H

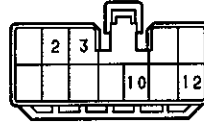

⑩K

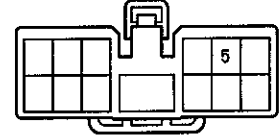

②B 黑色

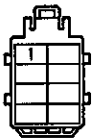

③C 青色

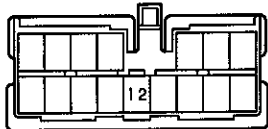

A3 灰色

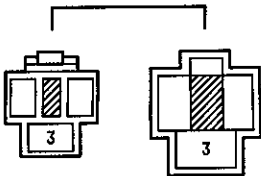

J1

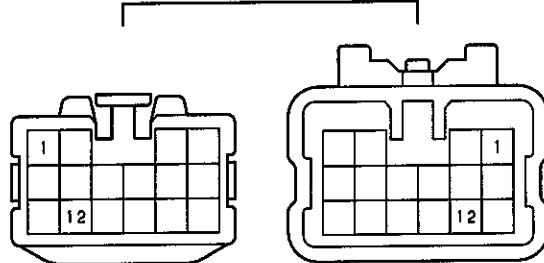



テール ランプ

⊙ ランプ フェイリアなし
 ▲ ランプ フェイリア付き

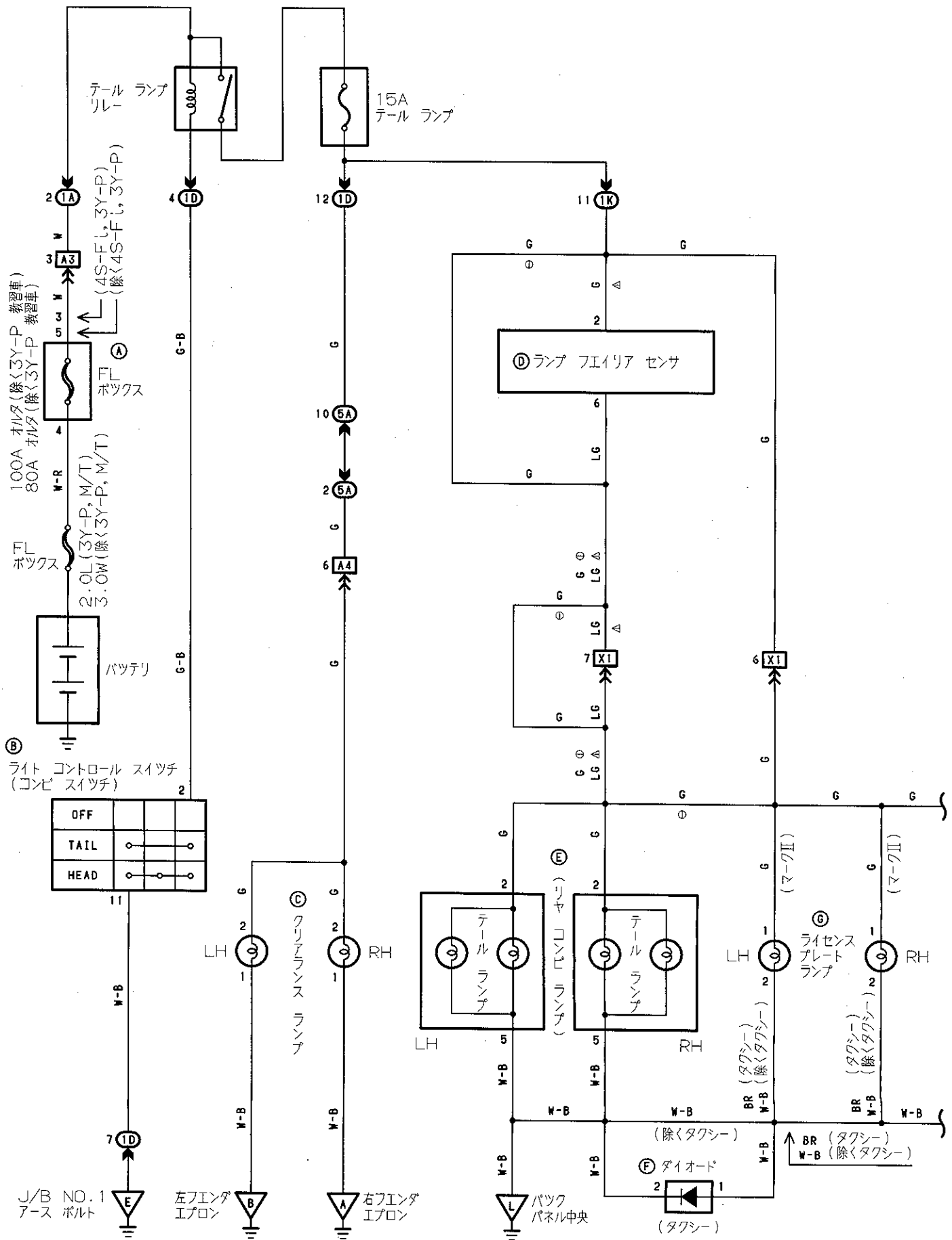

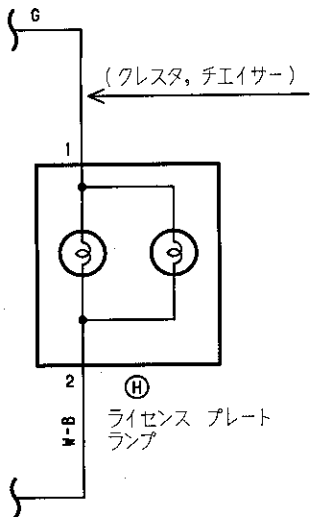
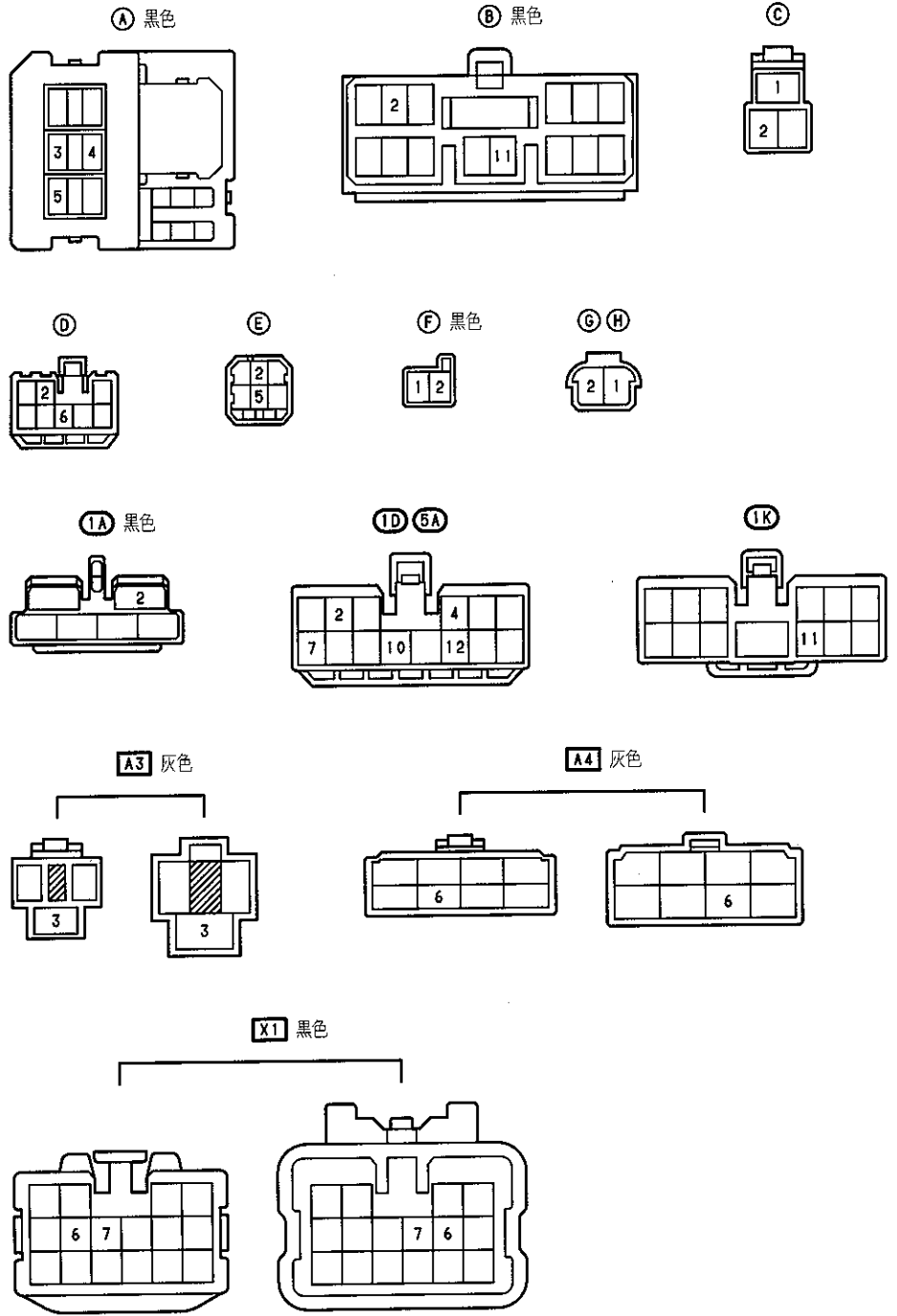



イルミネーション

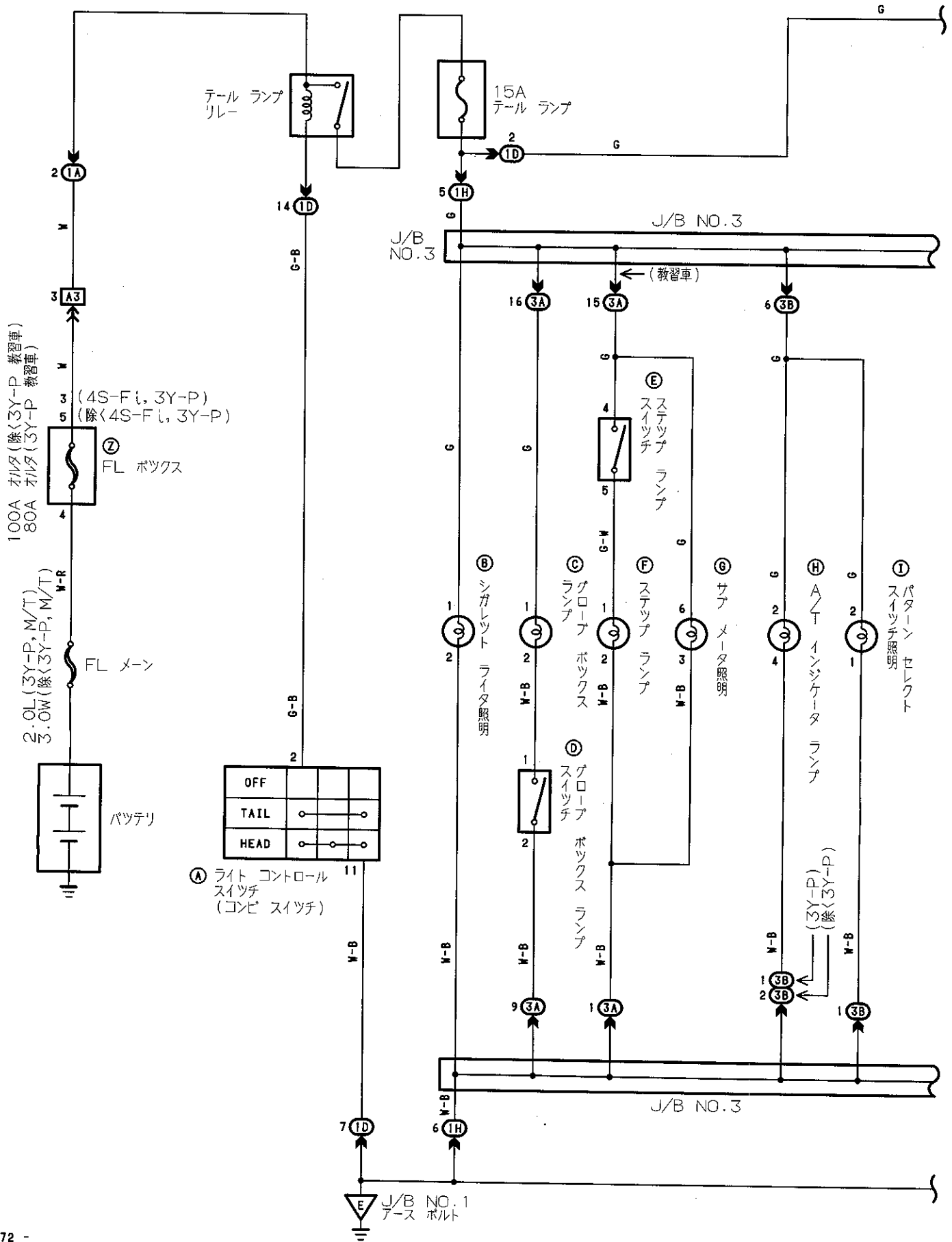

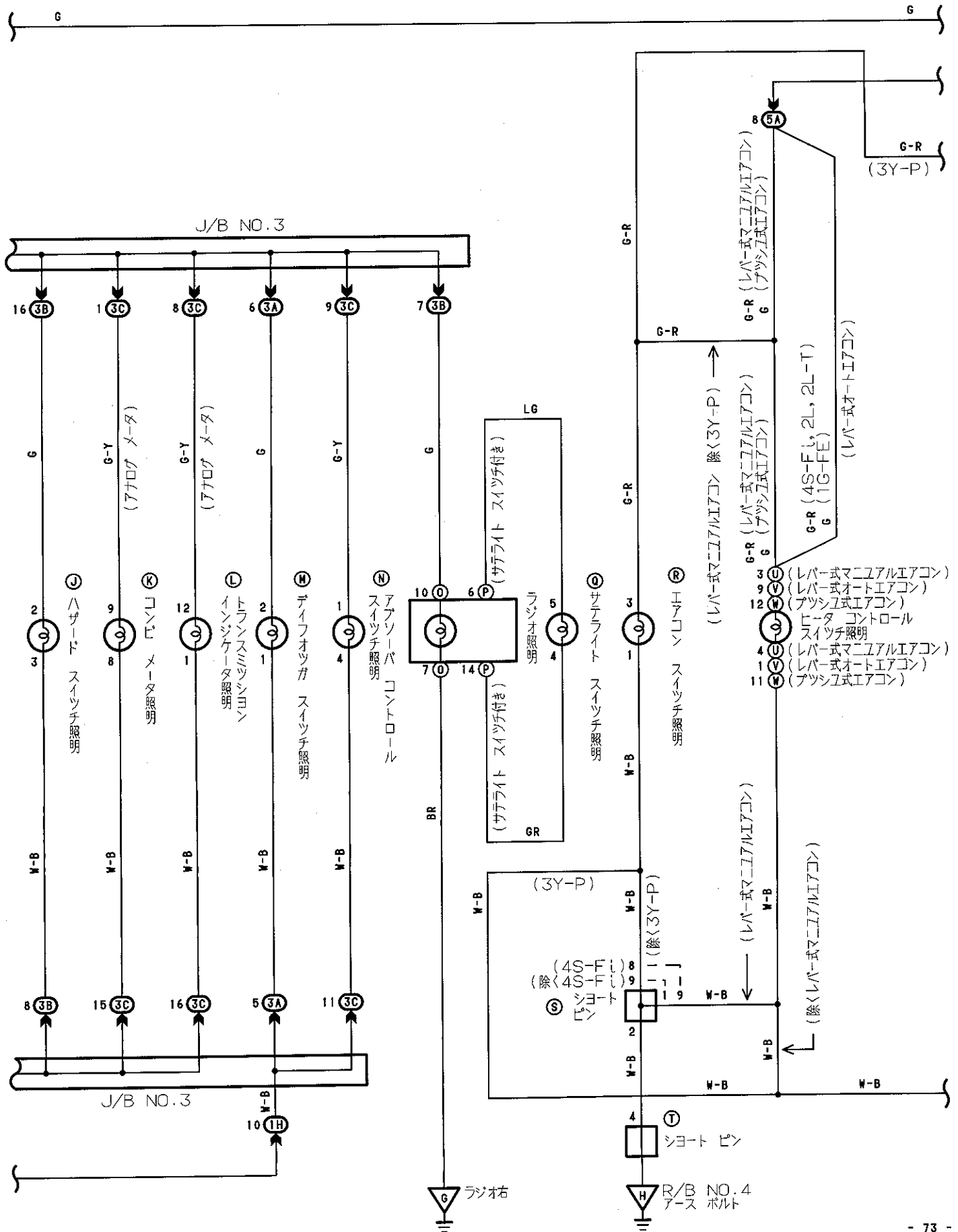



イルミネーション

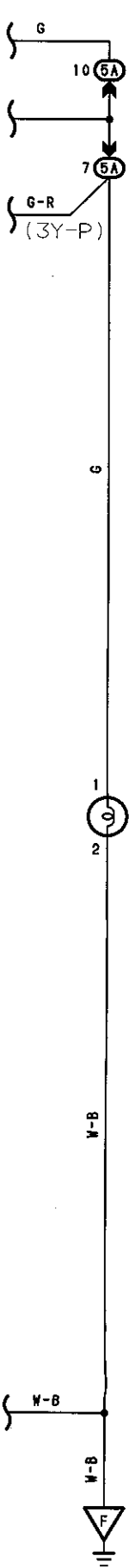

ⓧ エア
スイッチ照明
ピコピコファイア

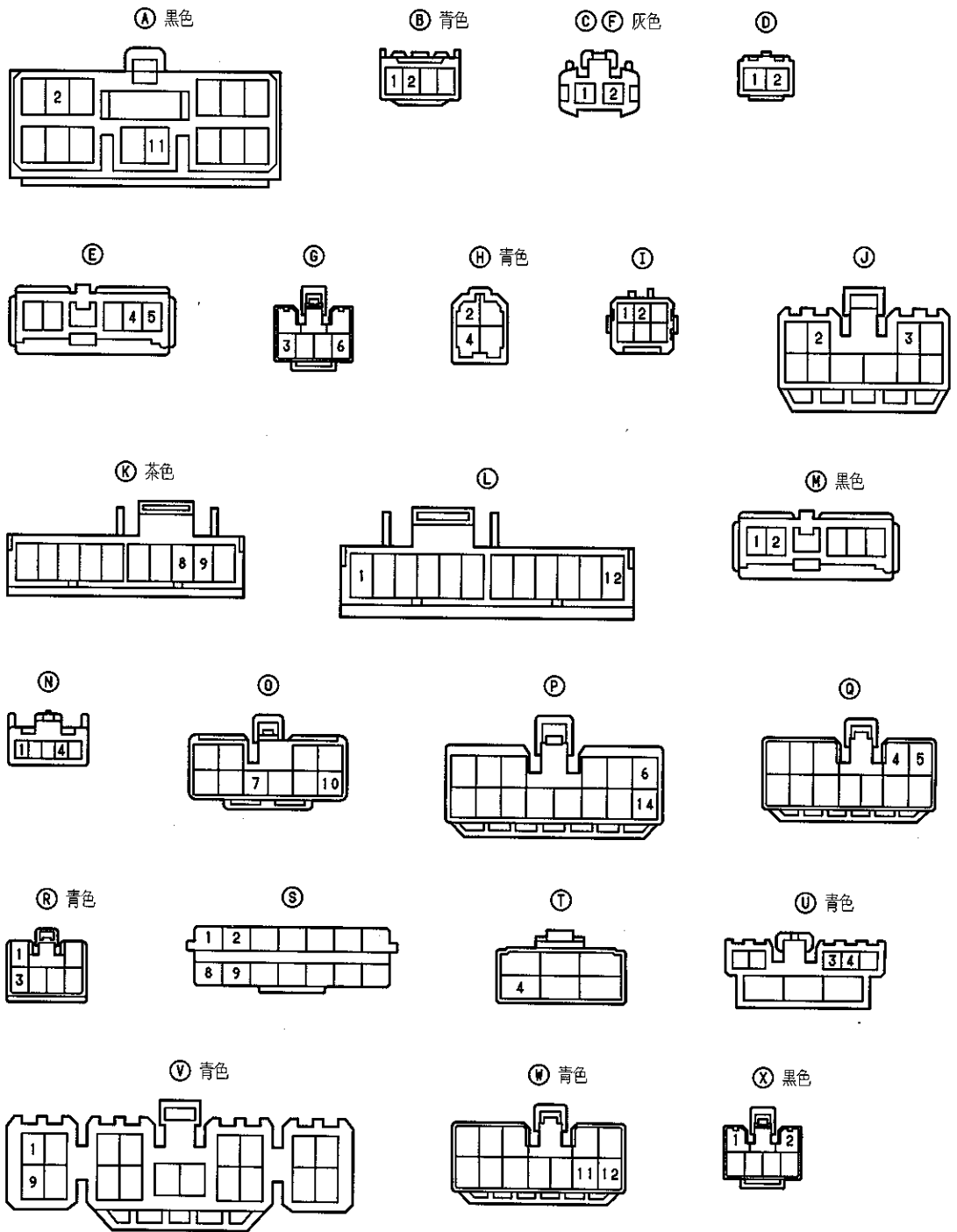

1A 黒色

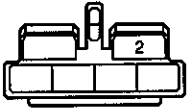

1D 5A

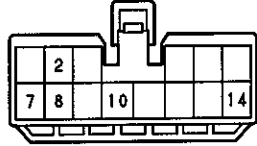

1H

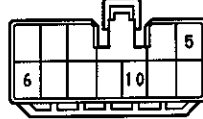

3A

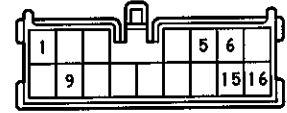

3B だいだい色

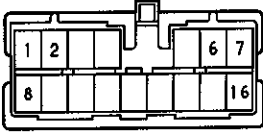

3C 青色

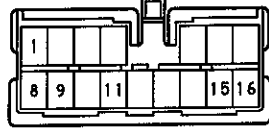

A3 灰色

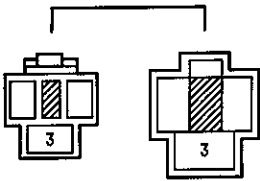



ターン シグナル & ハザード

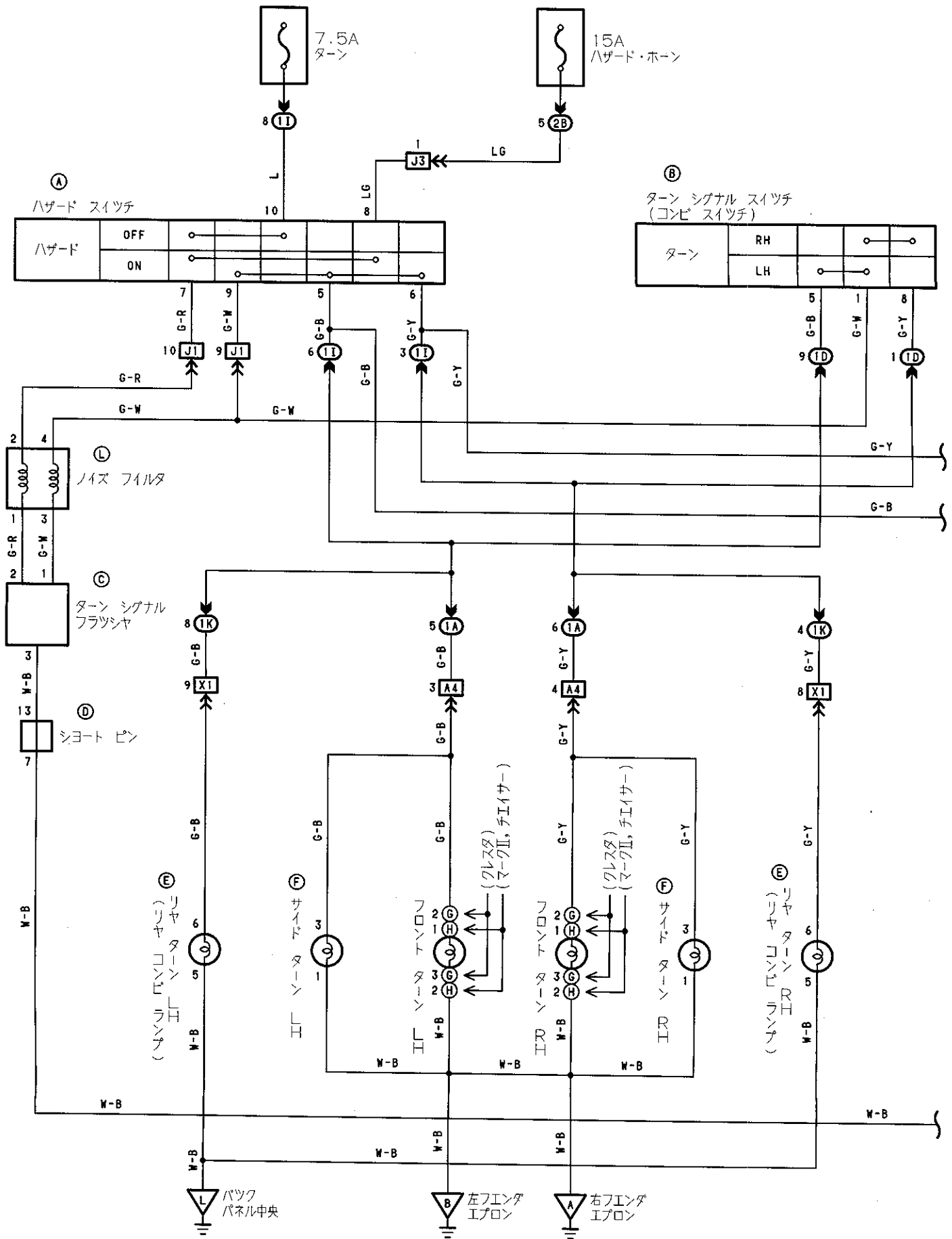

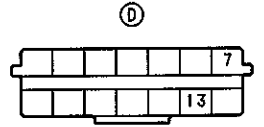
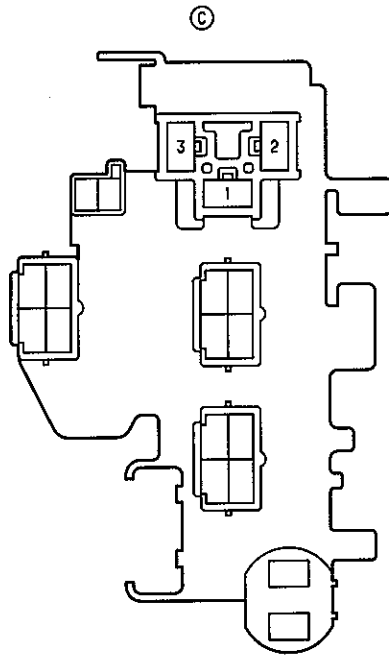
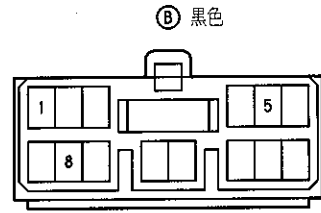
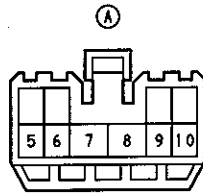
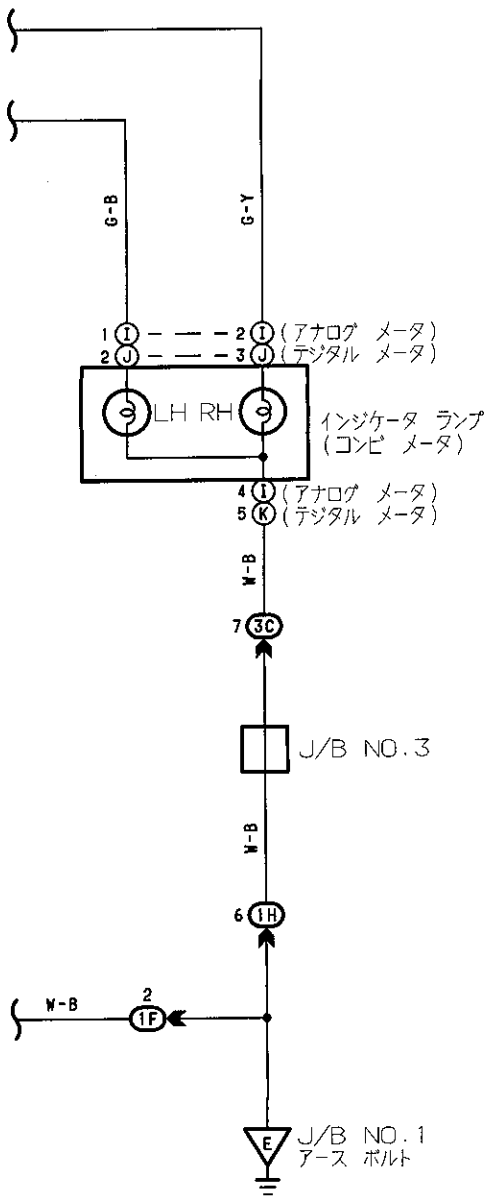

(J/B NO.1 カセット)

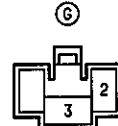

(I) 茶色

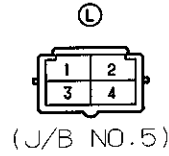
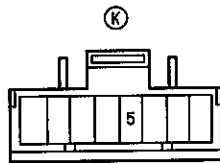
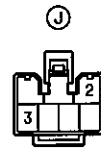
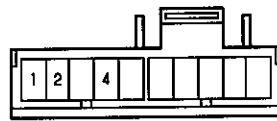



ターン シグナル & ハザード

1A 黒色

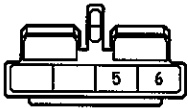

1D

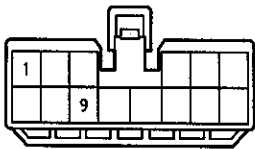

1F

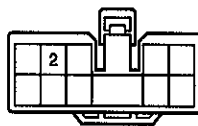

1H

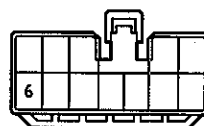

1J

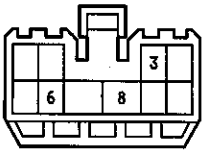

1K

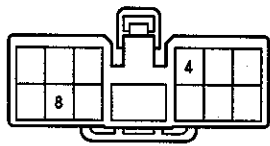

2B 黒色



3C 青色

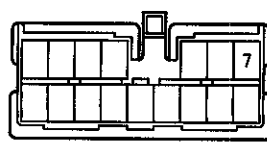

A4 灰色

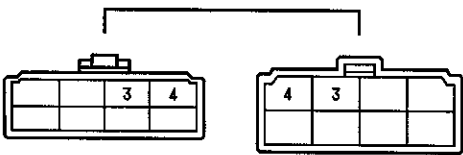

J1 J3

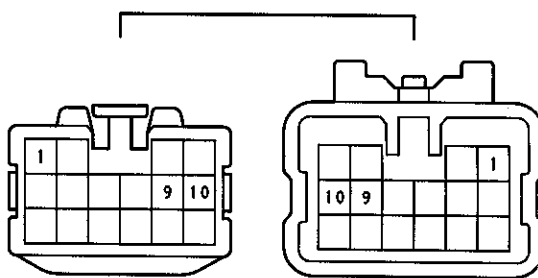

X1 黒色

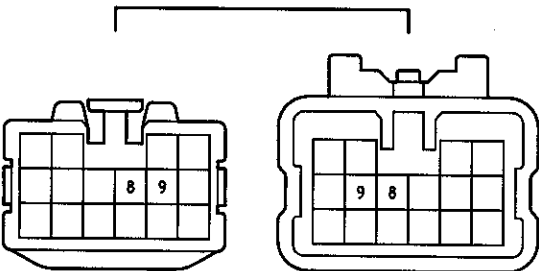

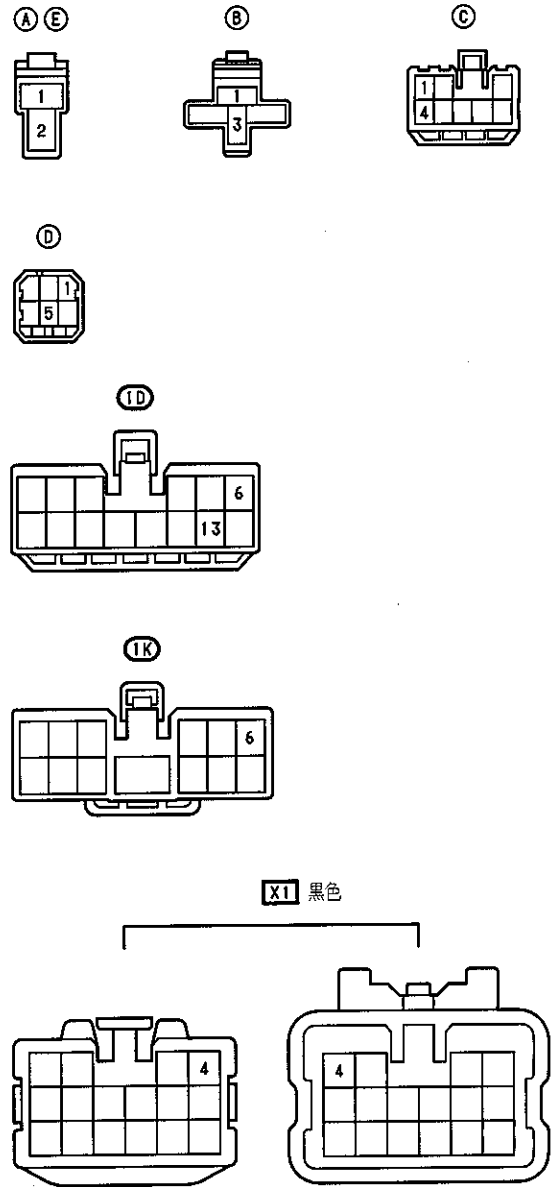
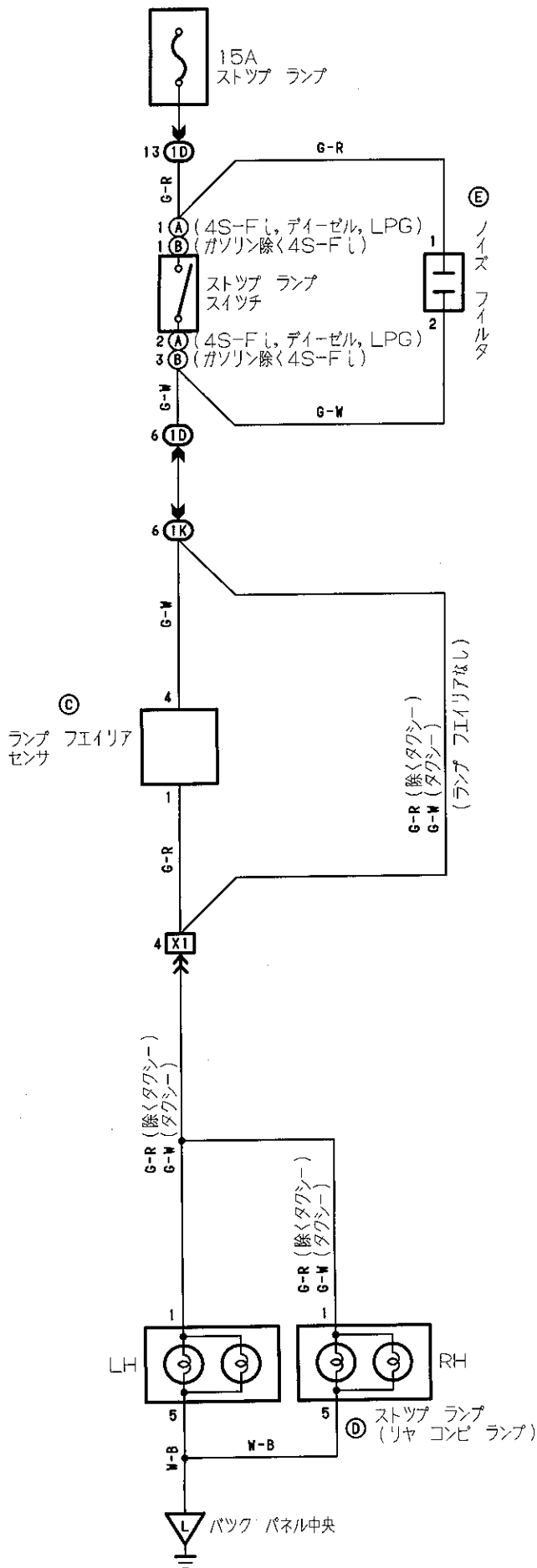

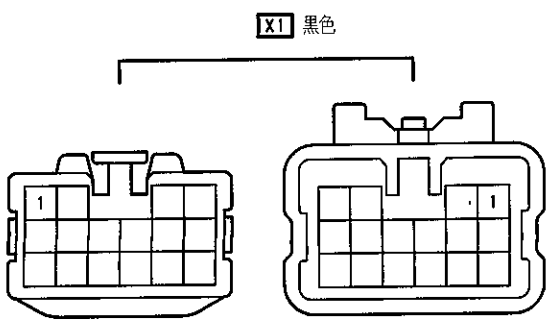
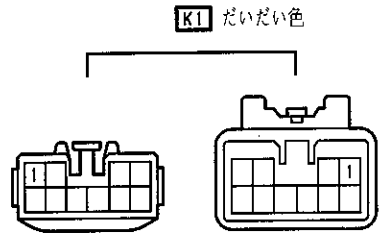
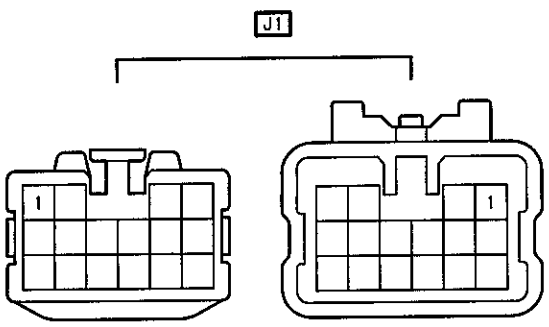
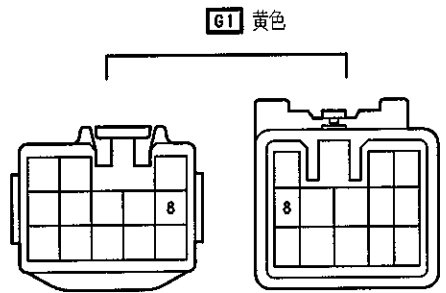
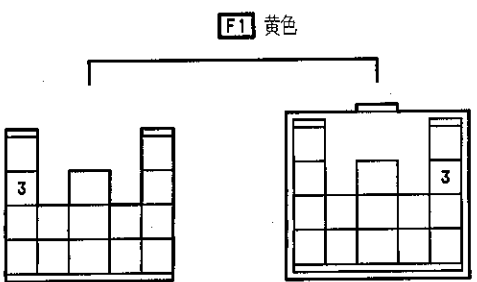
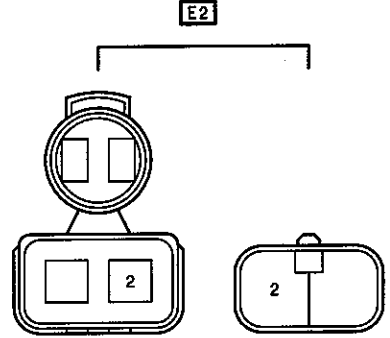
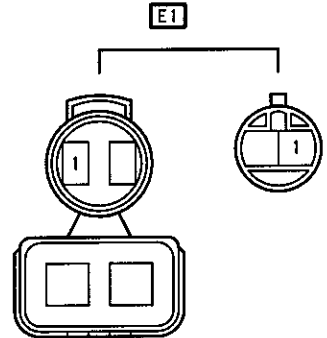
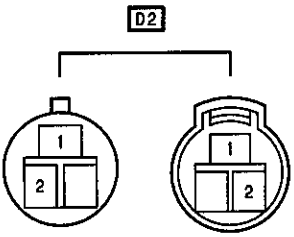
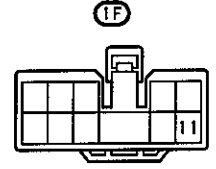
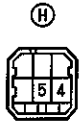
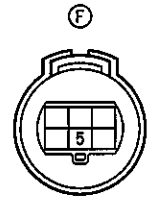
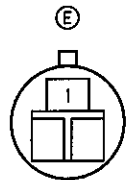
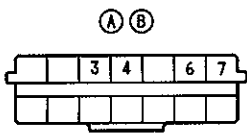



リヤ ライト ウォーニング

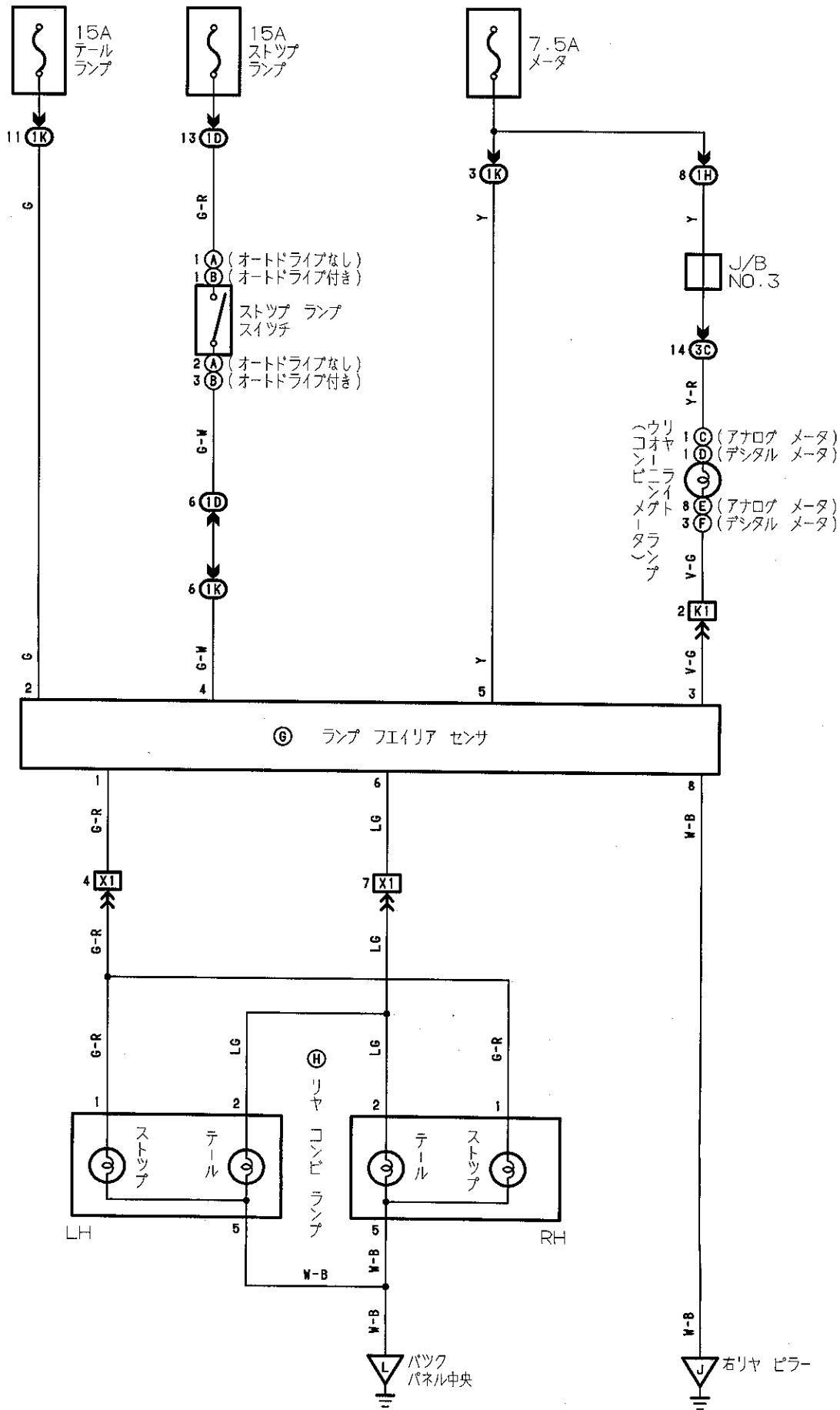

Ⓐ



Ⓑ



Ⓒ Ⓕ 茶色

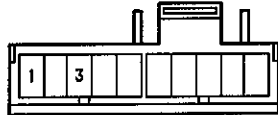

Ⓓ 灰色

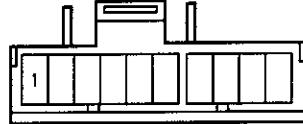

Ⓔ 青色

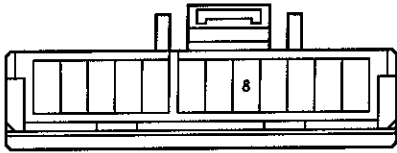

Ⓖ



Ⓕ



ⓓ

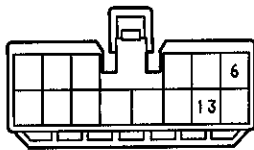

ⓗ

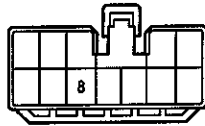

Ⓚ

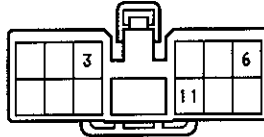

ⓐ 青色

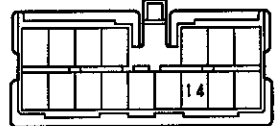

ⓀⓁ だいだい色

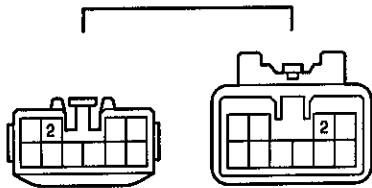

ⓀⓂ 黒色

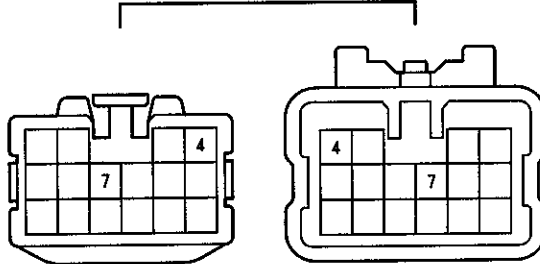



インテリア ランプ

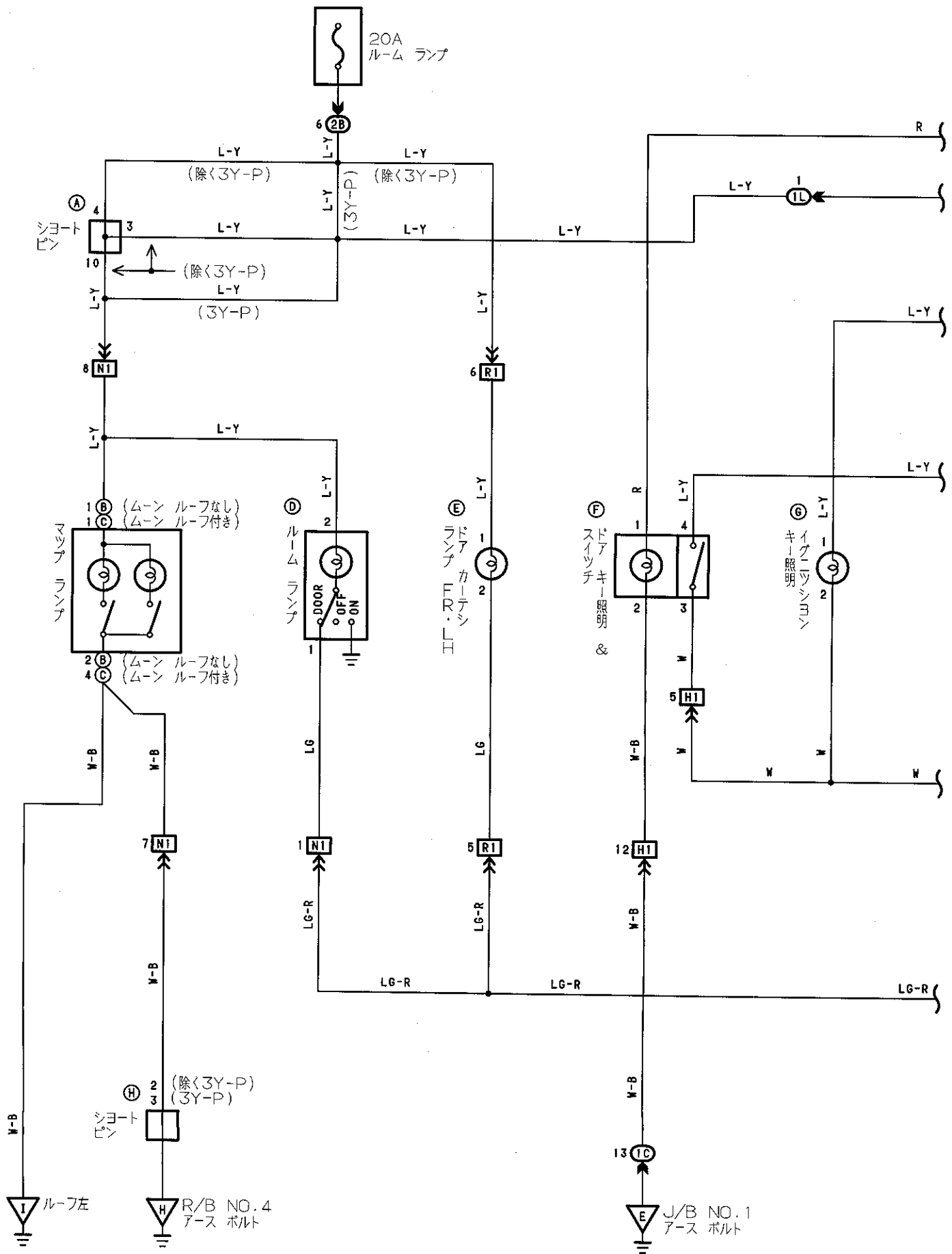



インテリア ランプ

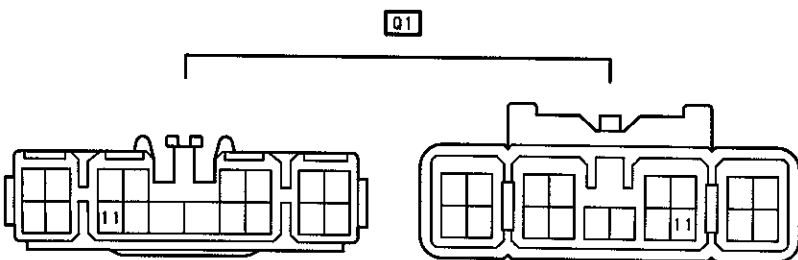
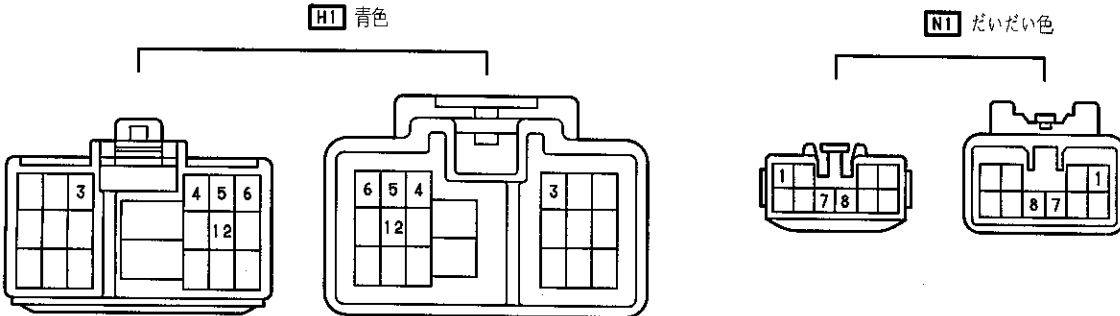
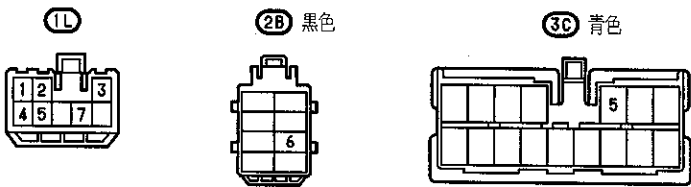
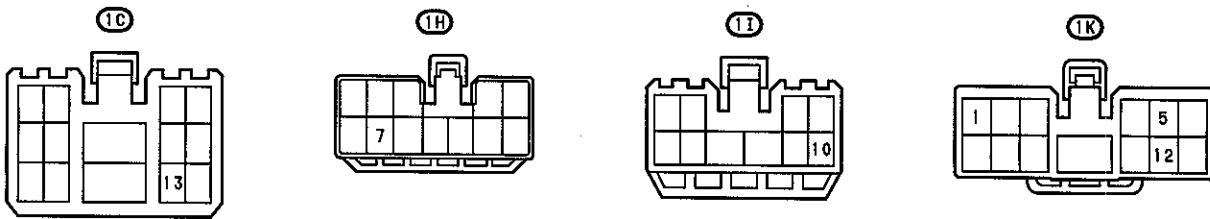
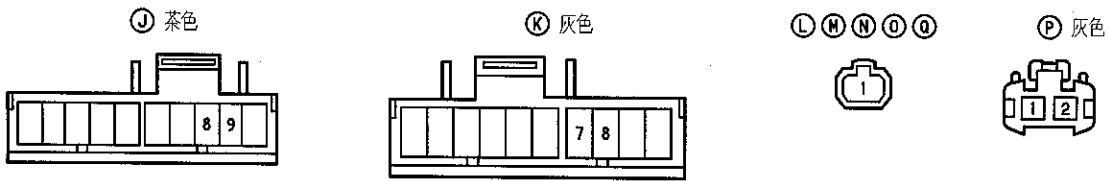
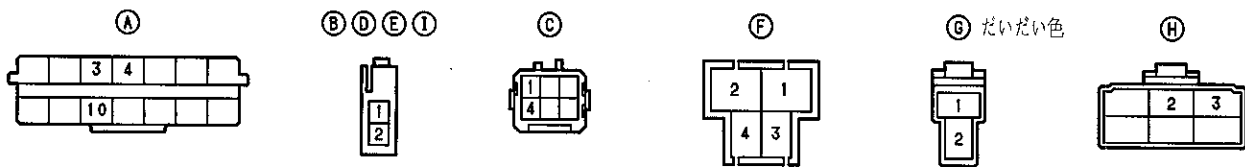

R1 青色

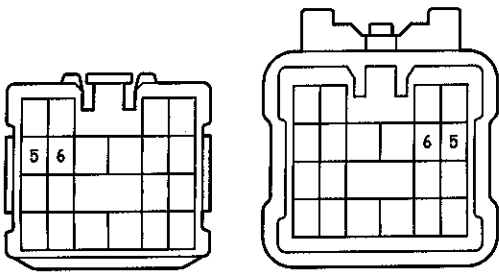

X1 黒色

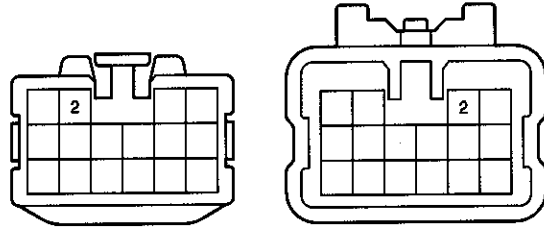

フオグ ランプ

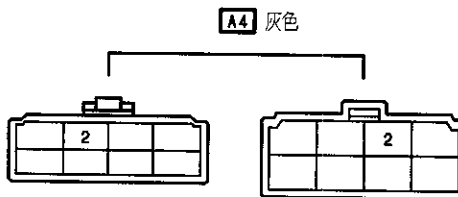
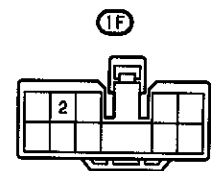
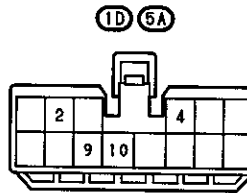
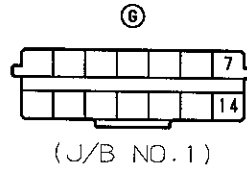
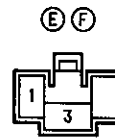
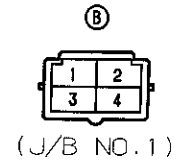
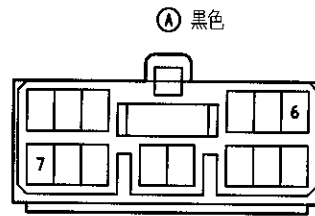
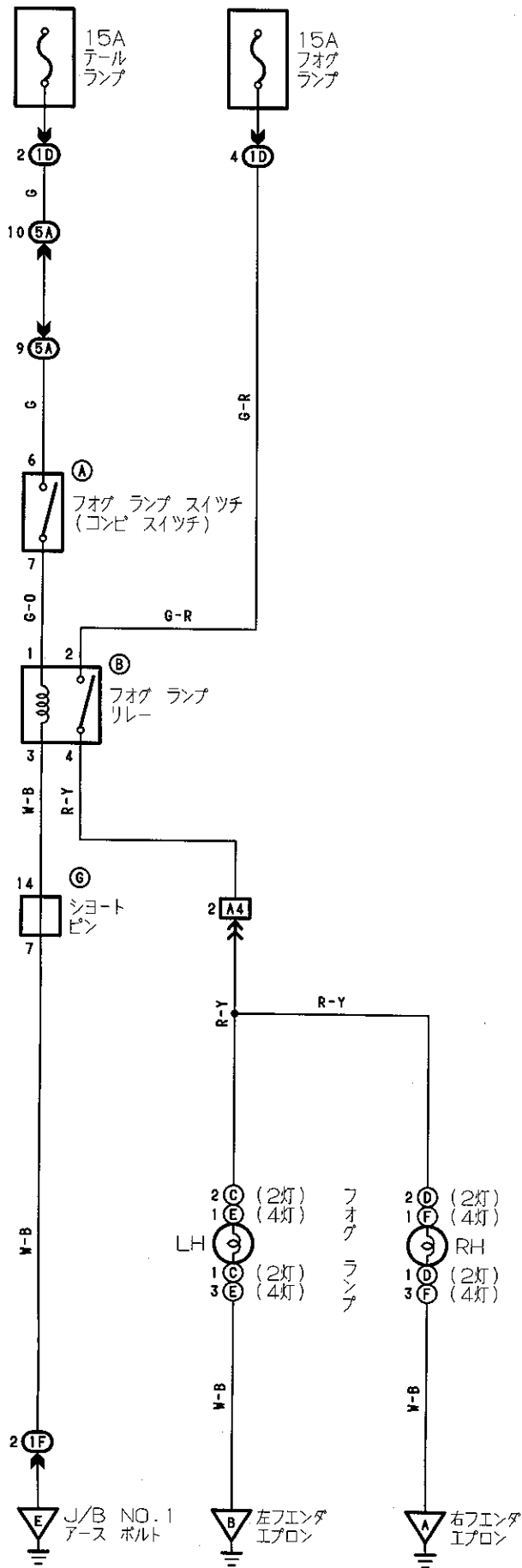

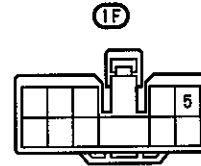
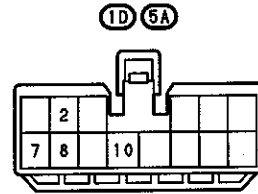
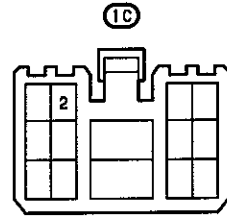
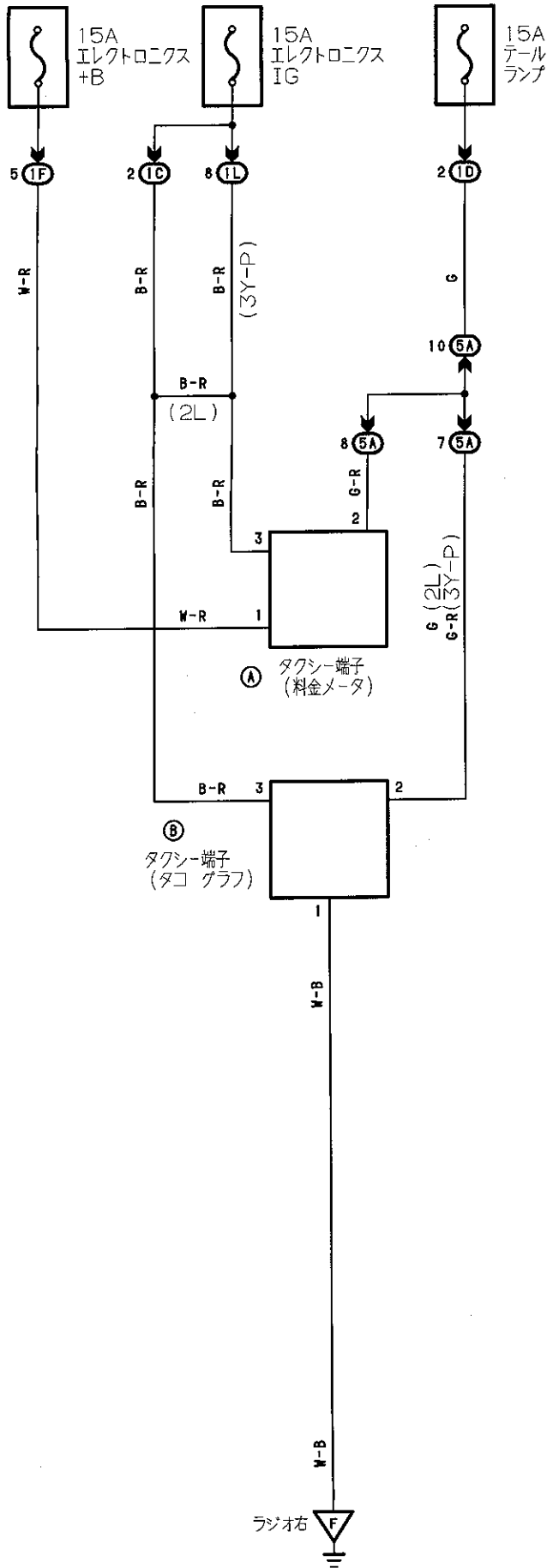

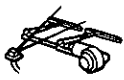

フロント ワイパ & ウオツシャ

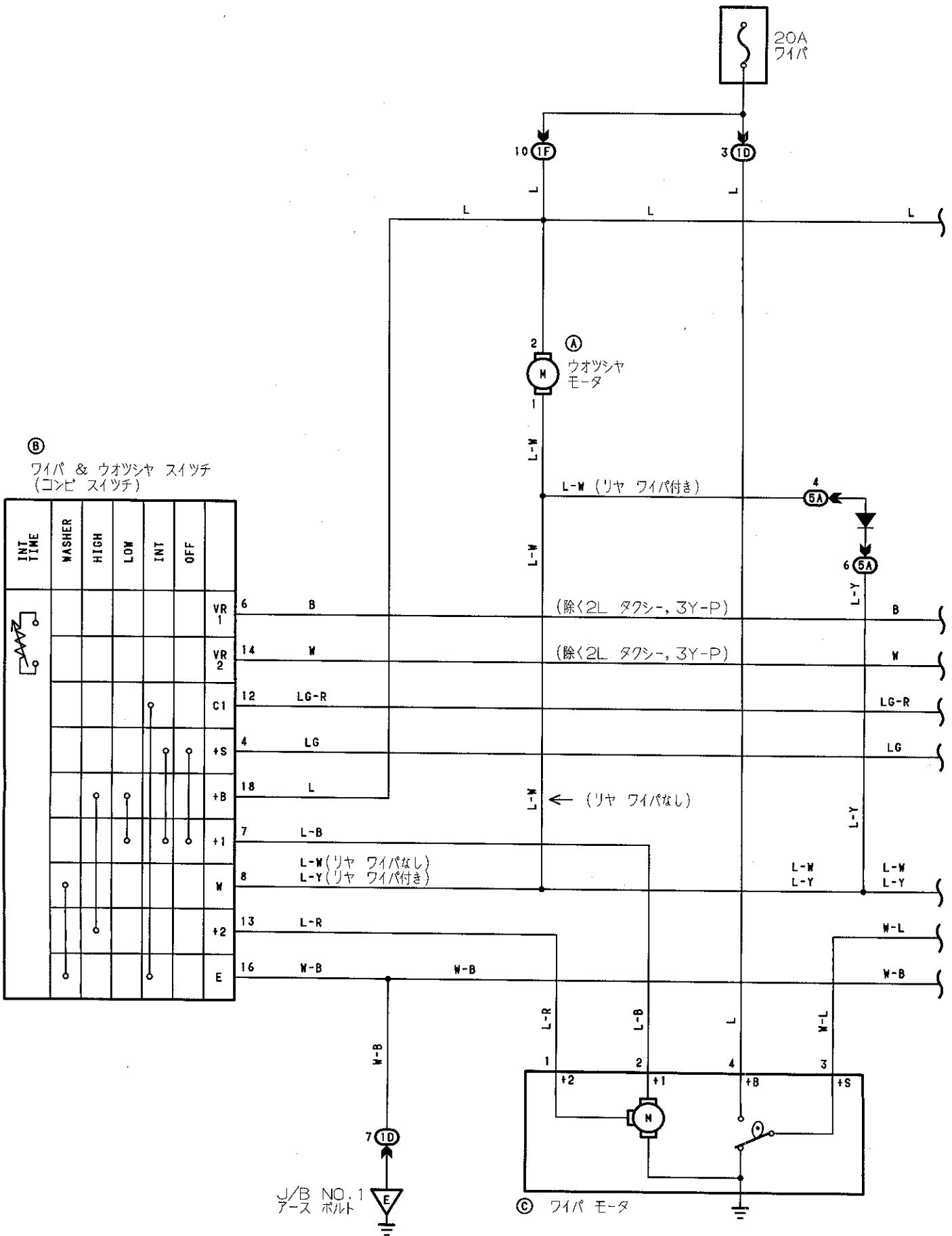

(B)
ワイパ & ウオツシャ スイッチ
(コンビスイッチ)

INT TIME	WASHER	HIGH	LOW	INT	OFF	
						VR 1
						VR 2
						C1
						+S
						+B
						+1
						W
						+2
						E

① 青色



② 黒色

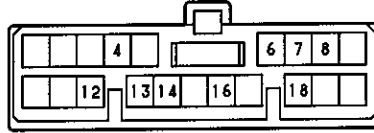

③



④

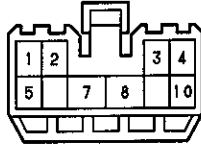

④D ⑤A

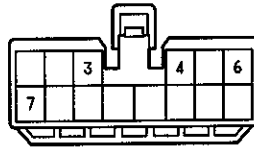

④F

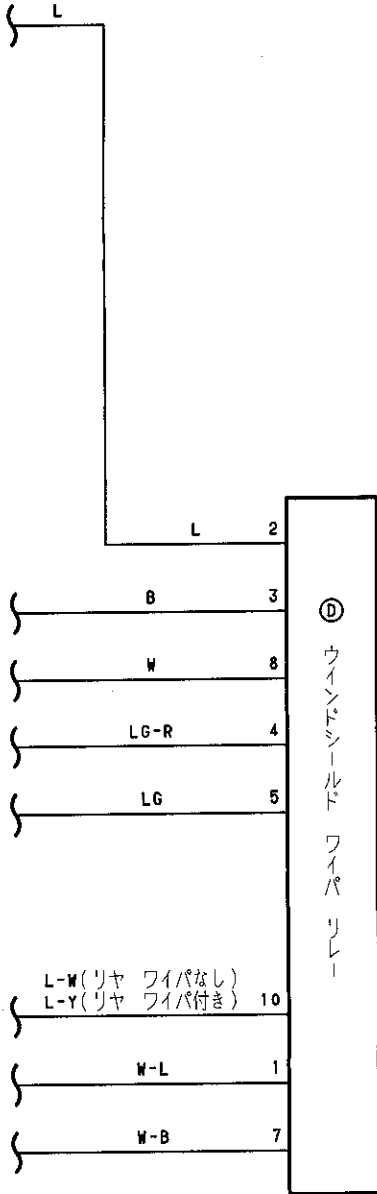
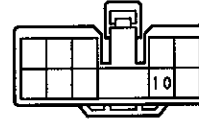



リヤ ワイパ & ウオツシャ

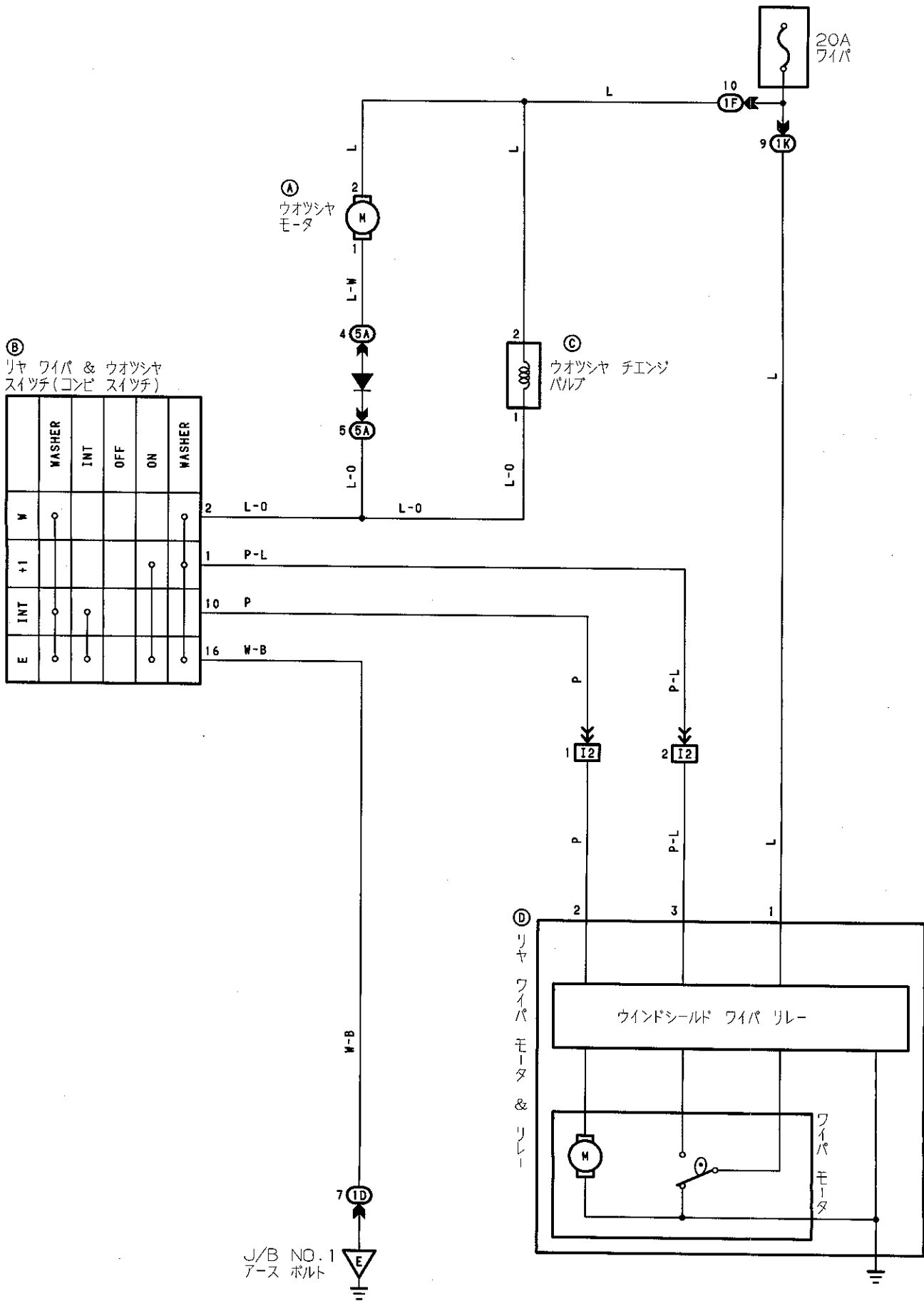

Ⓐ 青色

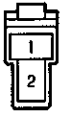

Ⓑ 黒色

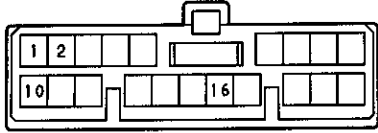

Ⓒ



Ⓓ



ⓓ Ⓞ

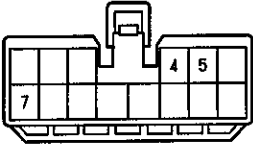

ⓕ

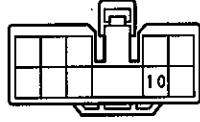

ⓖ

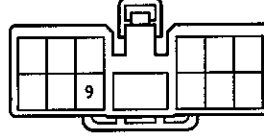

ⓗ

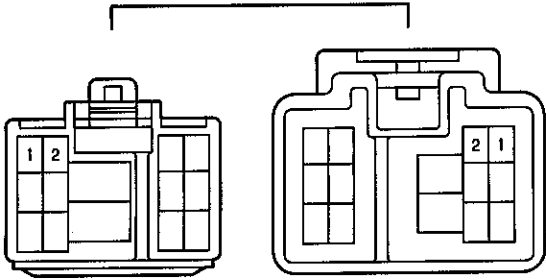

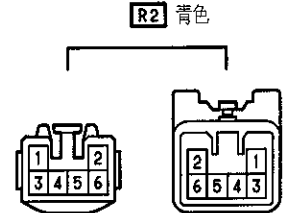
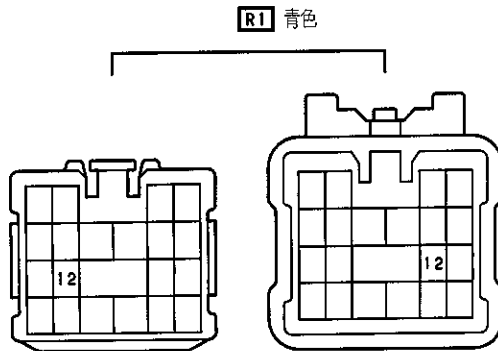
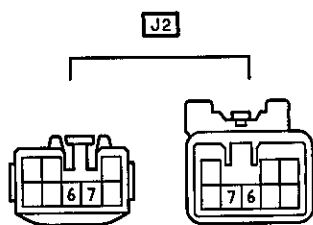
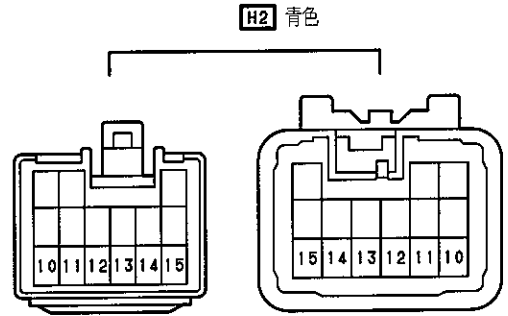
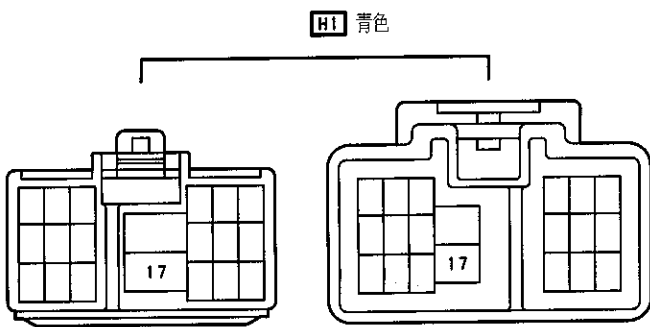
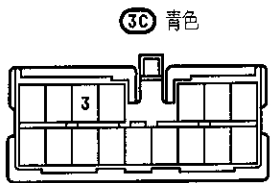
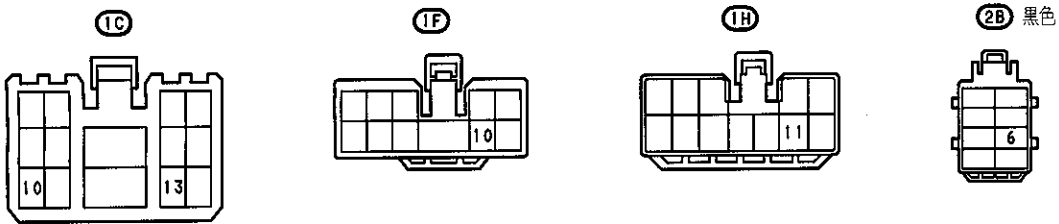
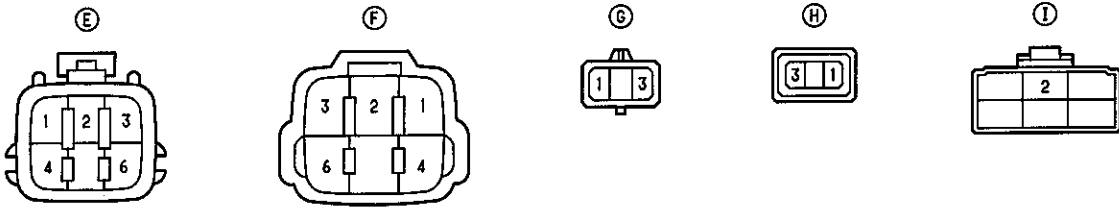
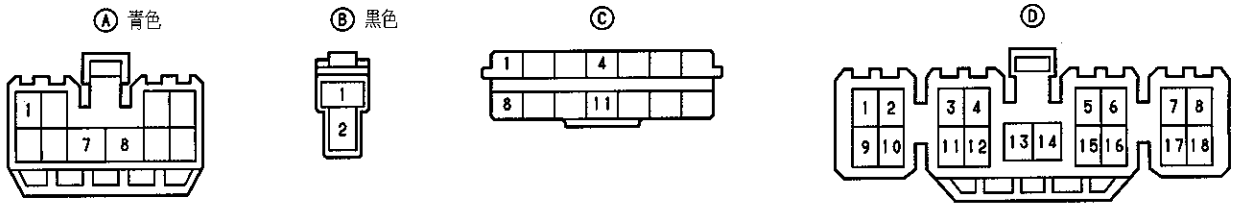



テンション リデューサ

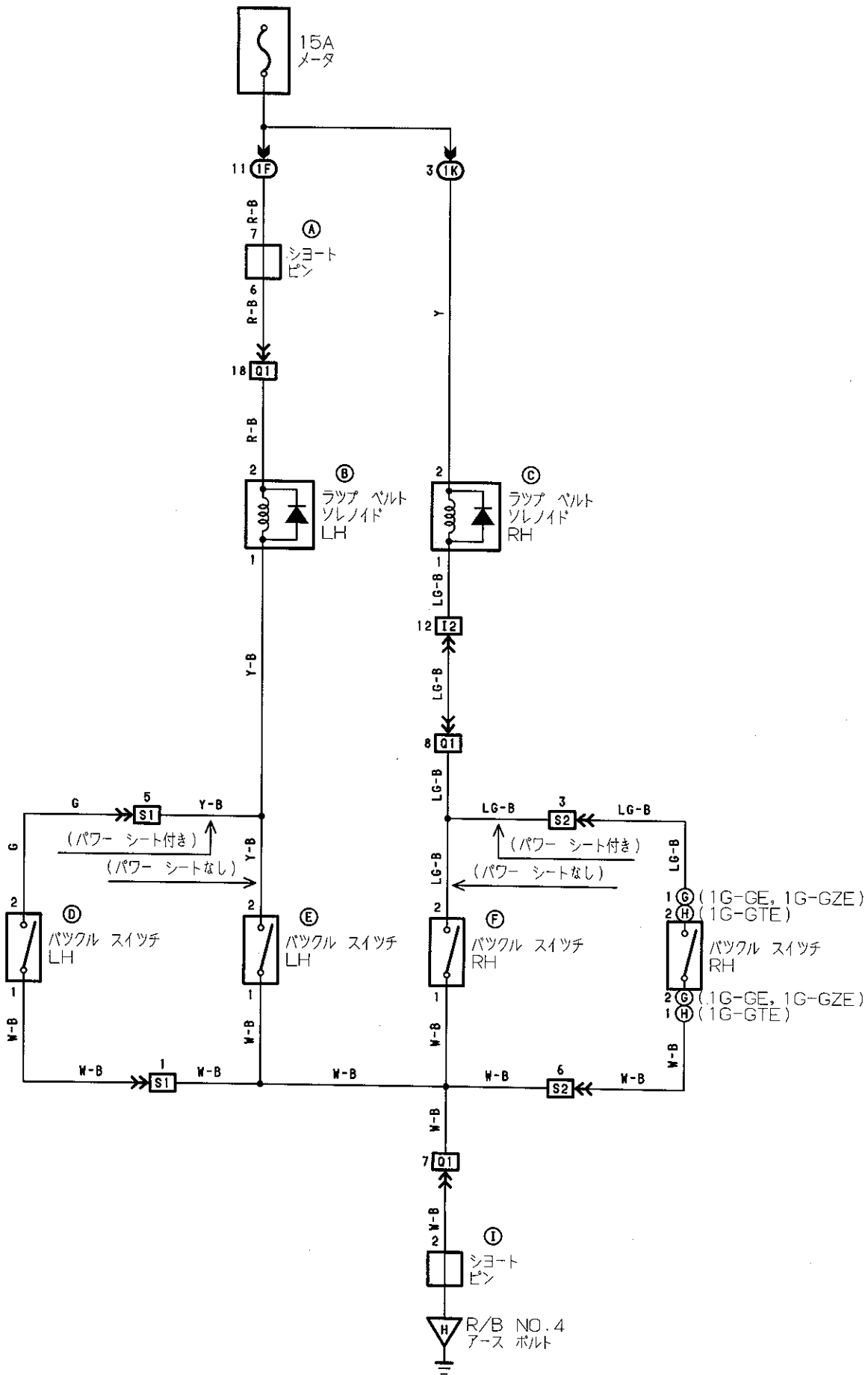

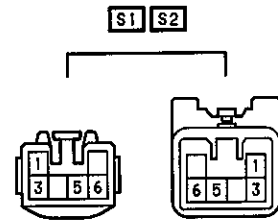
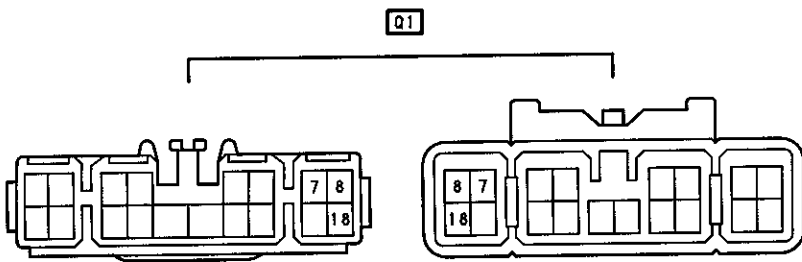
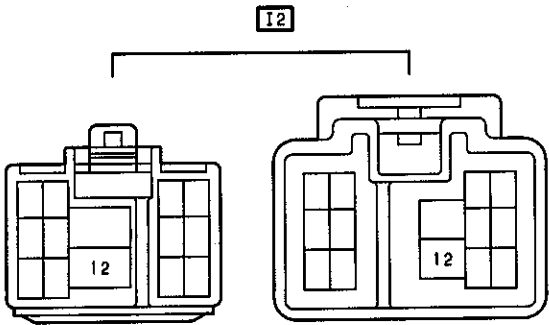
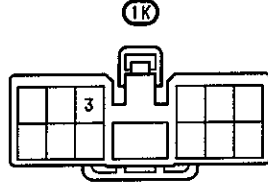
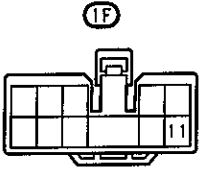
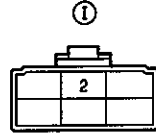
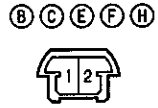
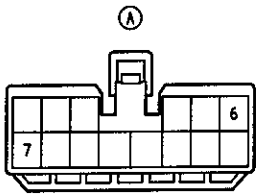



パワーシート (運転席)

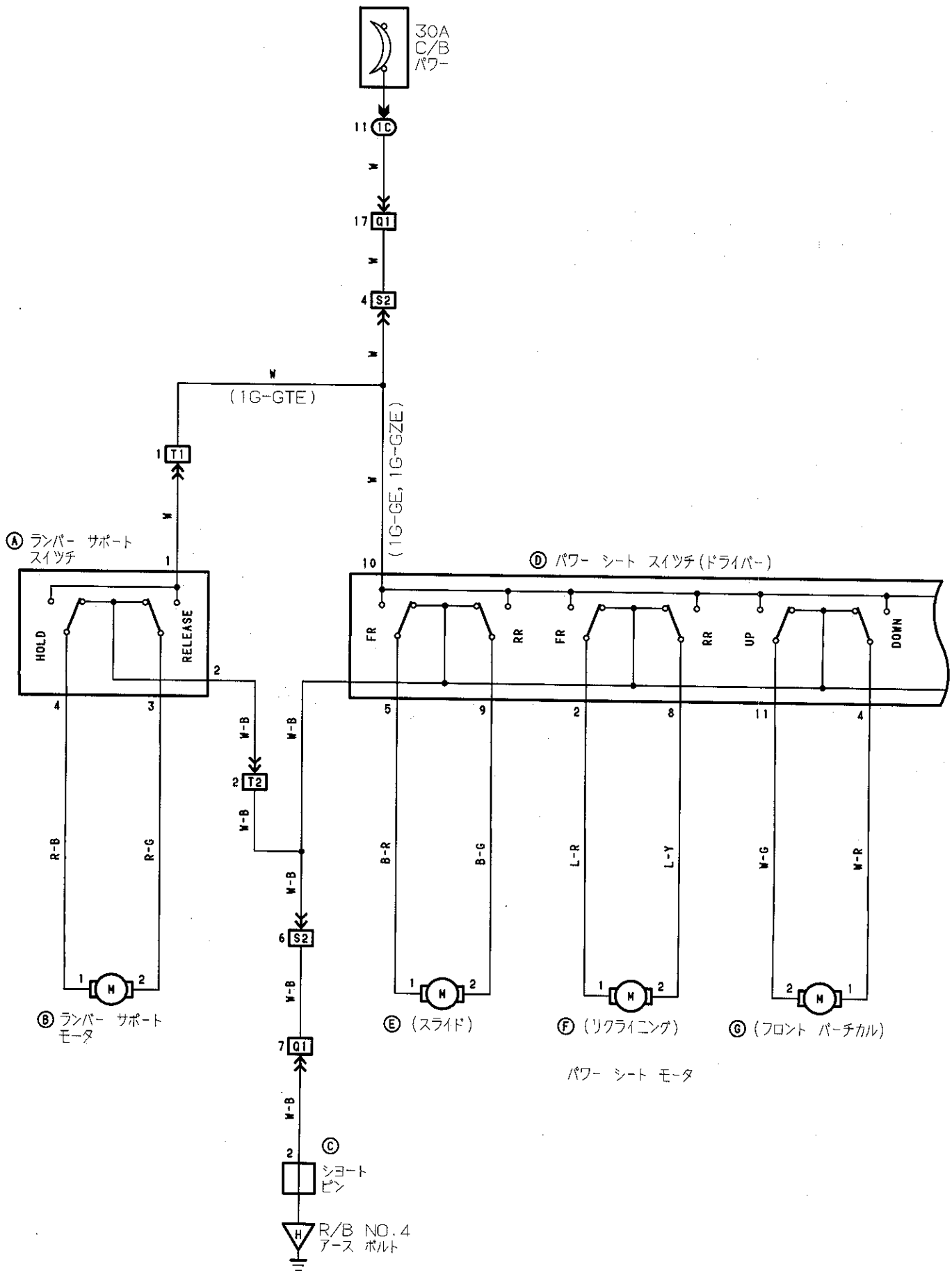

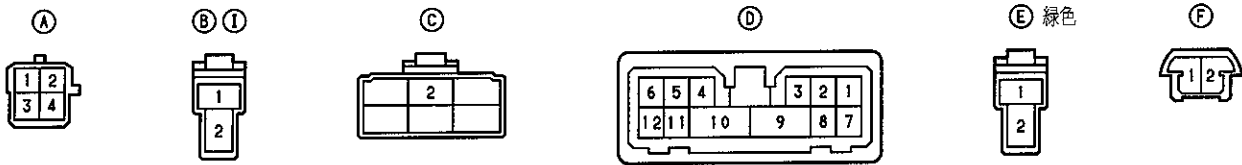

⑥ ⑧ だいだい色

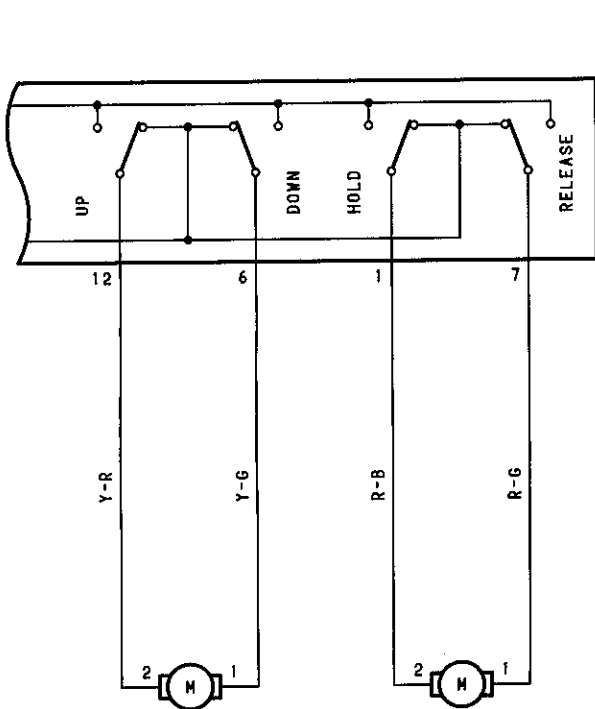
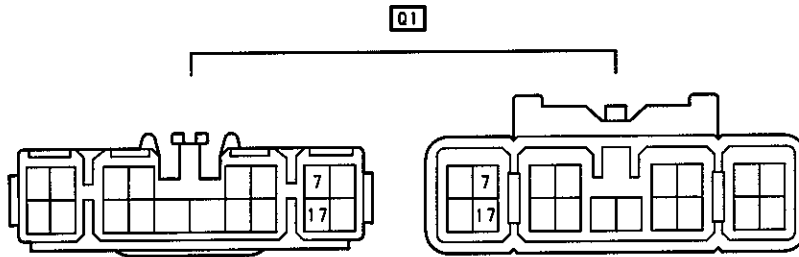
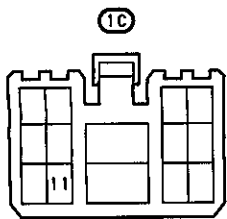
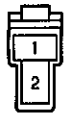

⑧ (リヤ パーチカル)

① (ランバー サポート)

パワー シート モータ

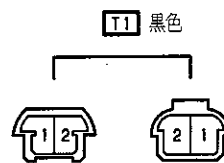
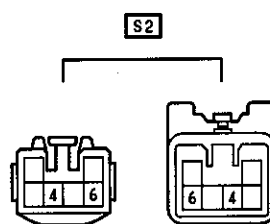

パワーシート (助手席)

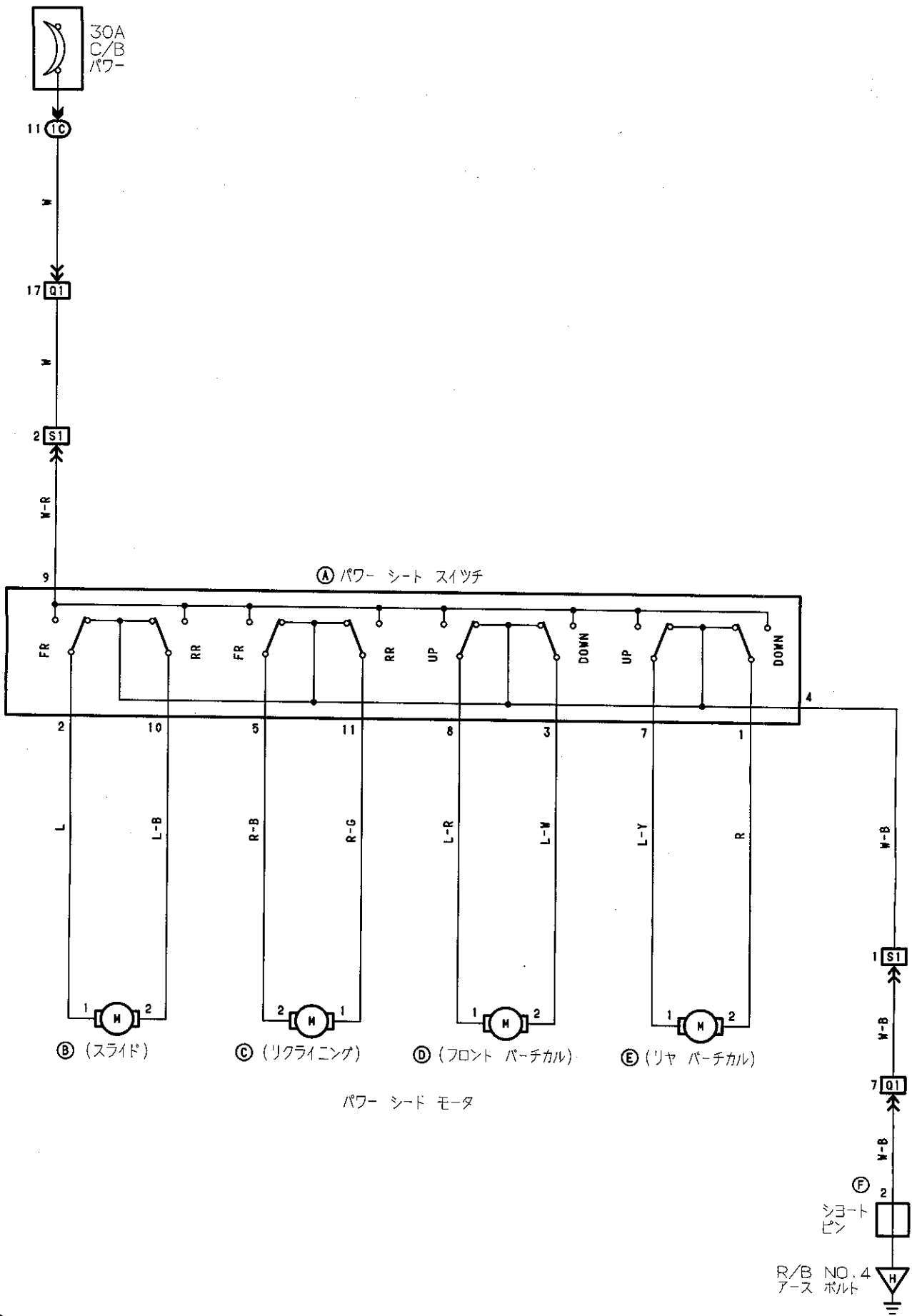

パワーシートモーター

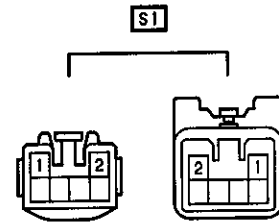
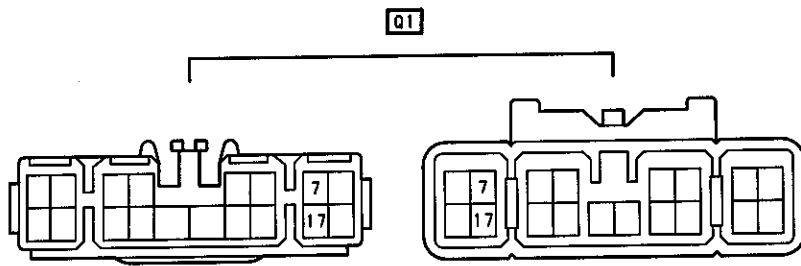
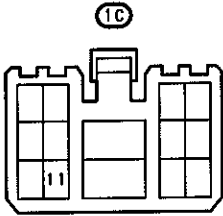
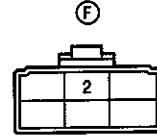
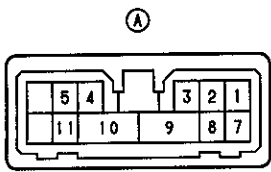

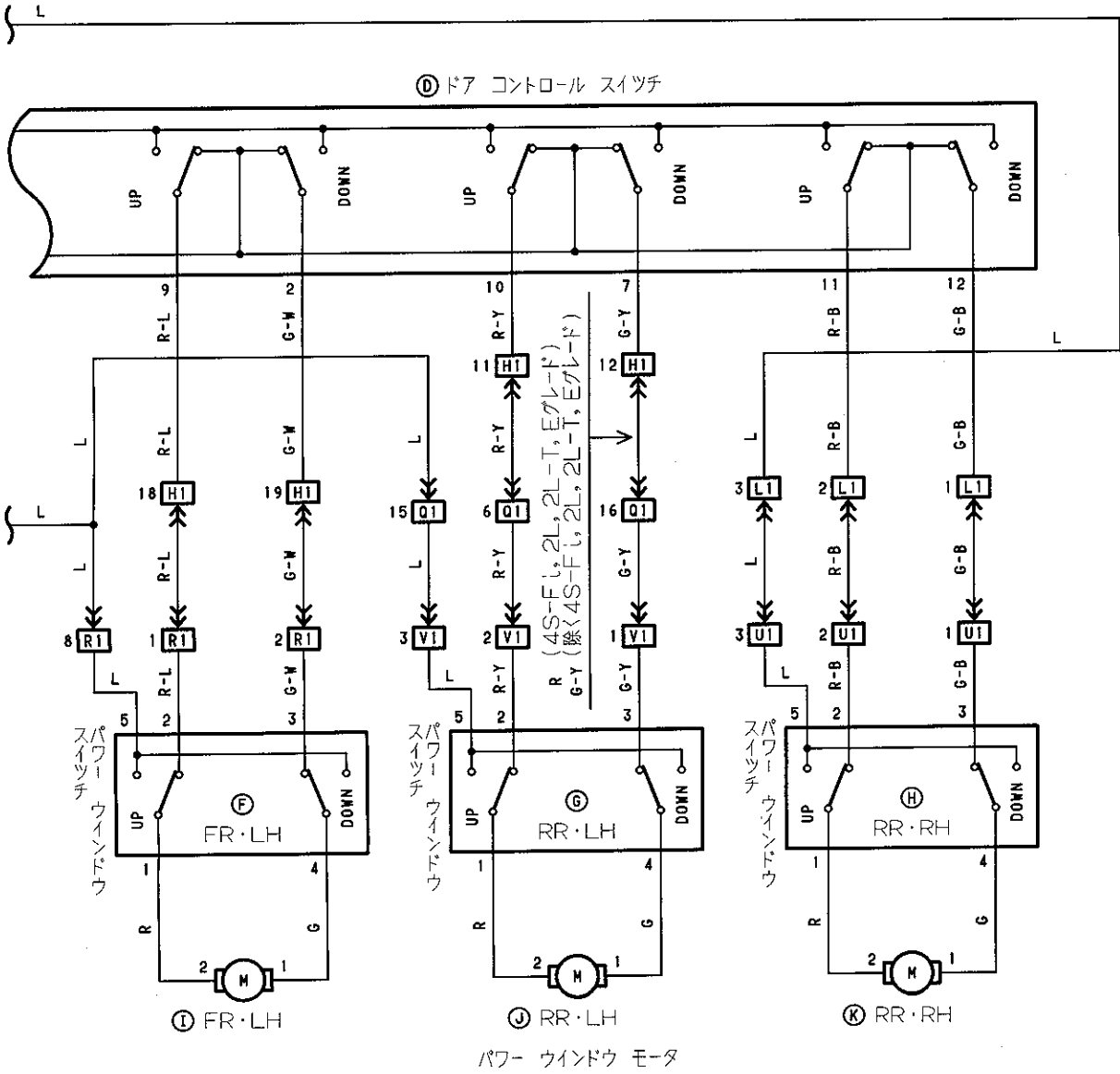



パワー ウィンドウ

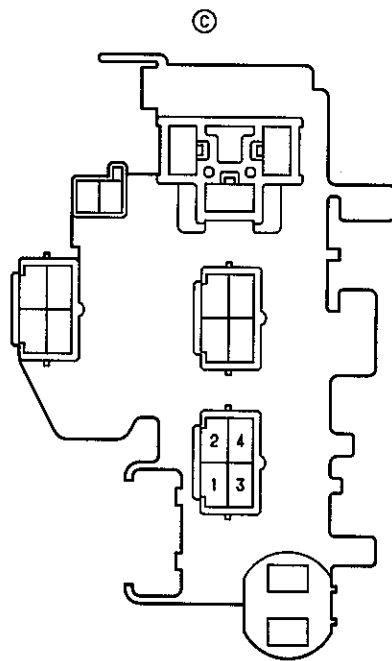
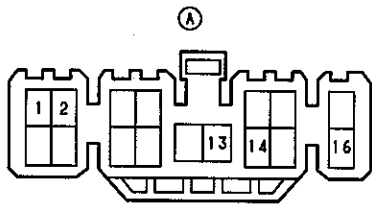

(J/B NO.1 カセット)

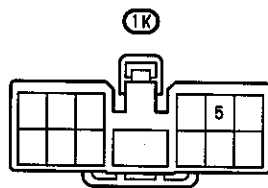
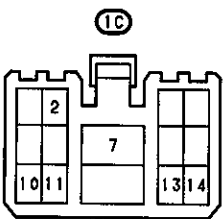
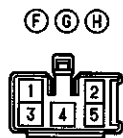
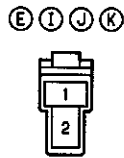
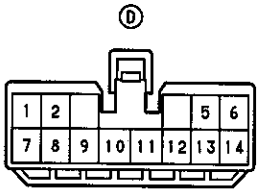

H1 青色

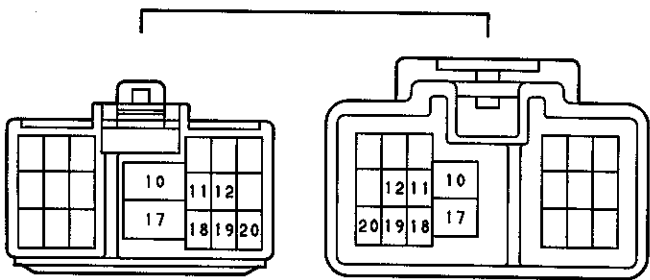

L1 青色

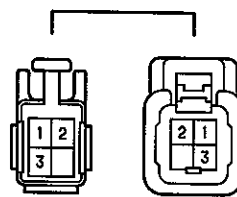

Q1

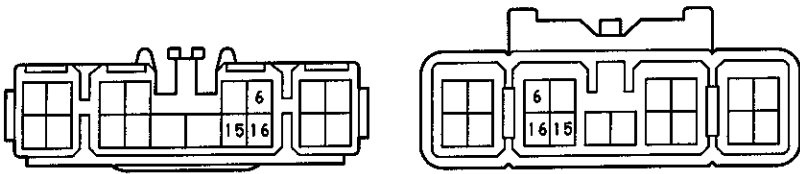

R1 青色

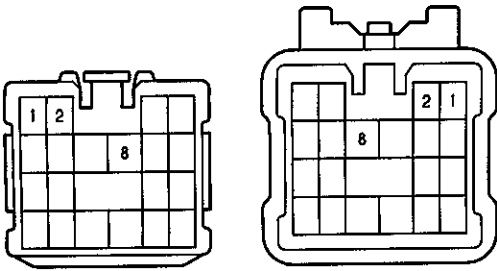

U1 V1 青色

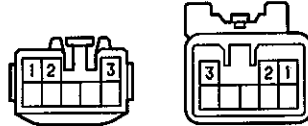



ドア ロック

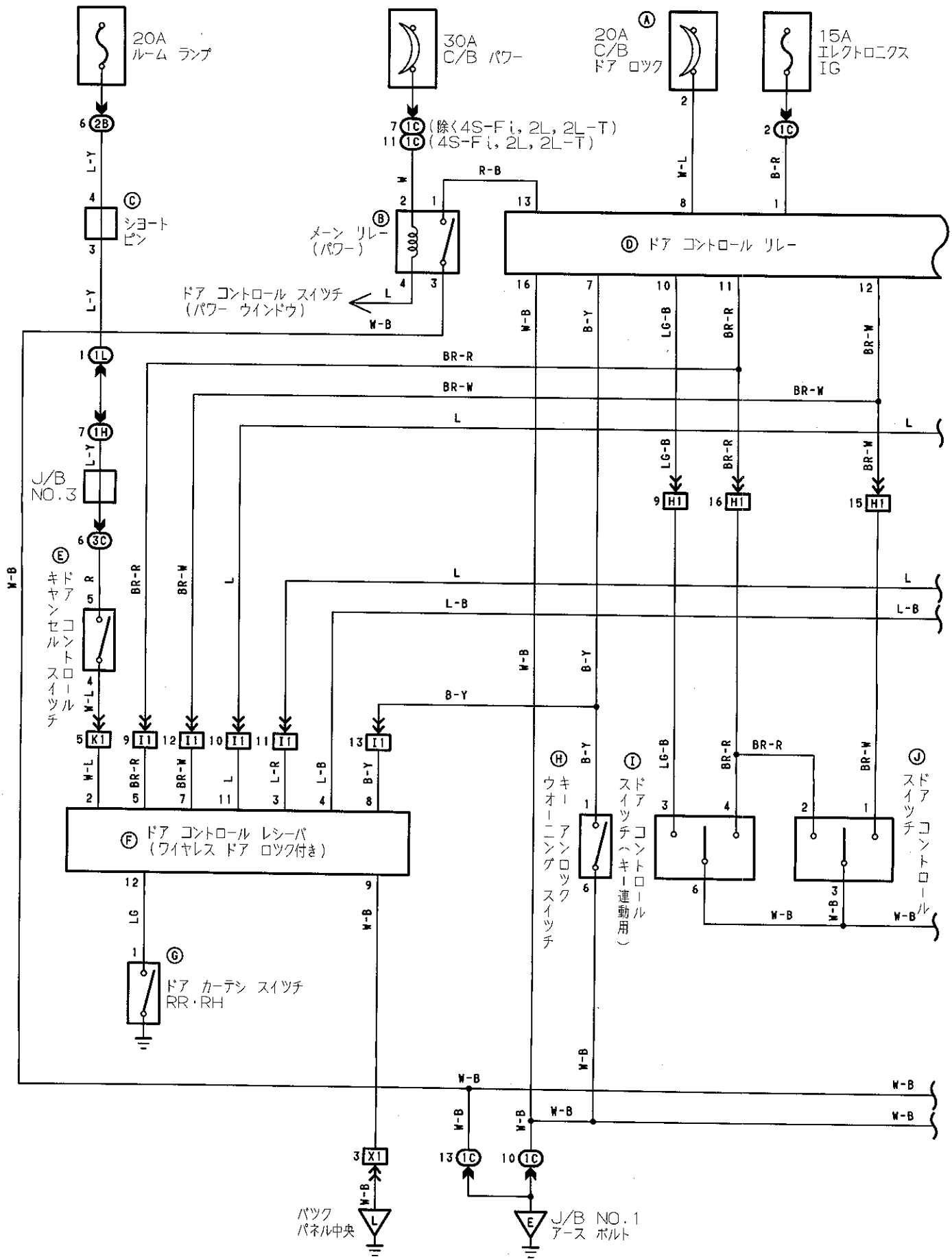

④ ドアコントロールリレー

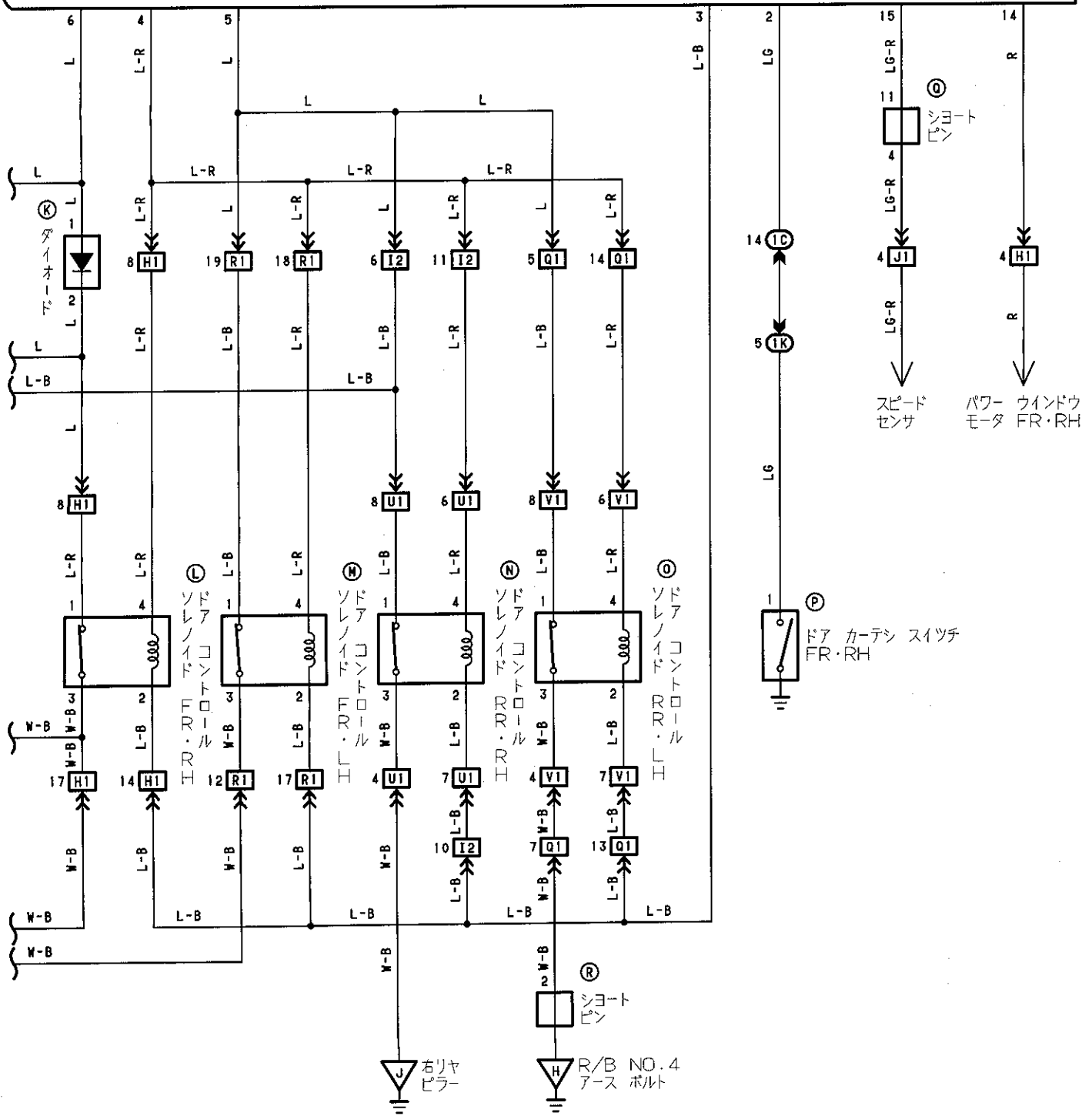



ドア ロック

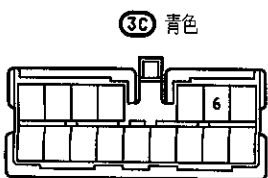
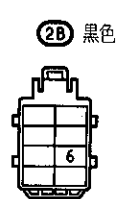
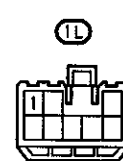
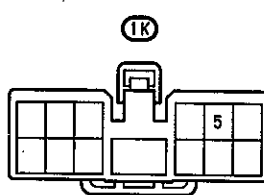
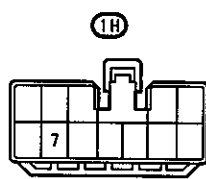
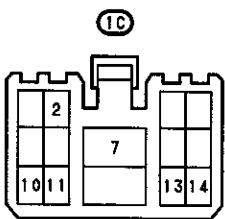
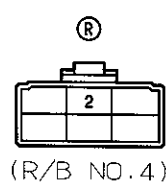
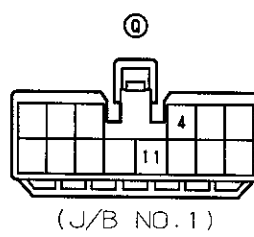
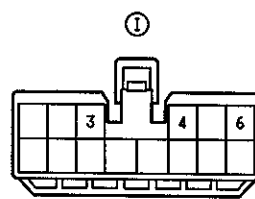
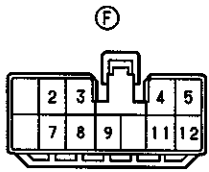
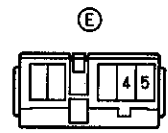
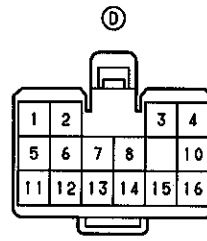
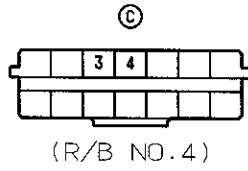
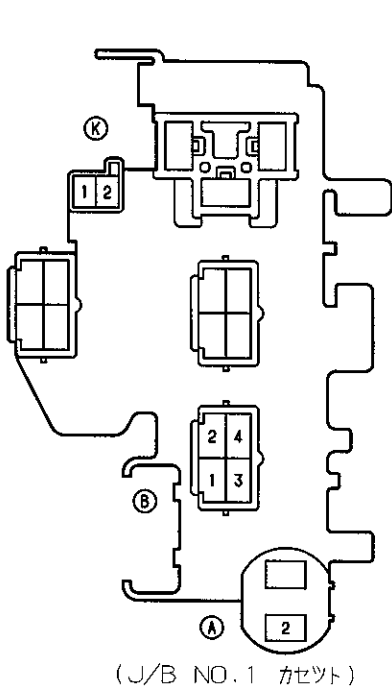

H1 青色

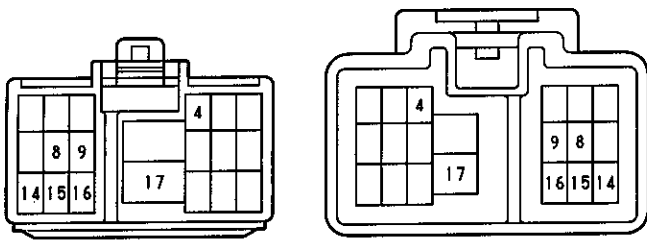

I1 灰色

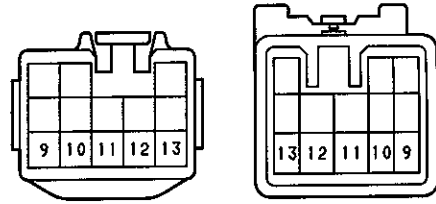

I2

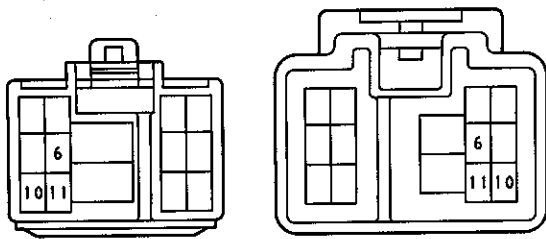

J1

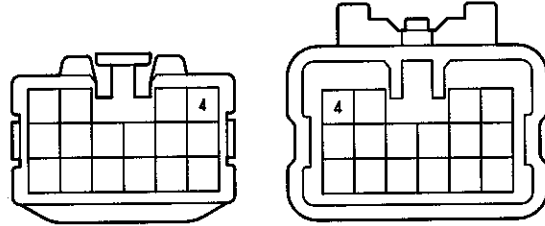

K1 だいたい色

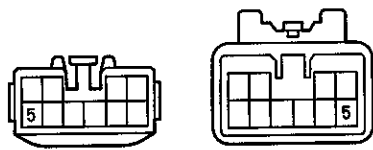

Q1

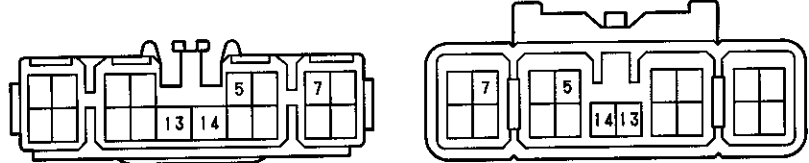

R1 青色

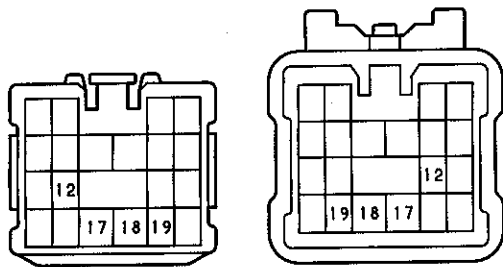

U1 V1 青色

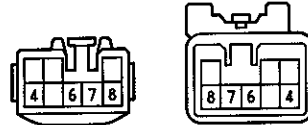

X1 黒色

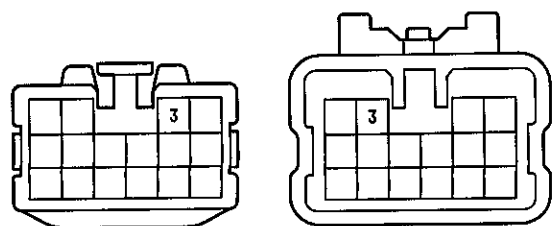

ムーン ルーフ

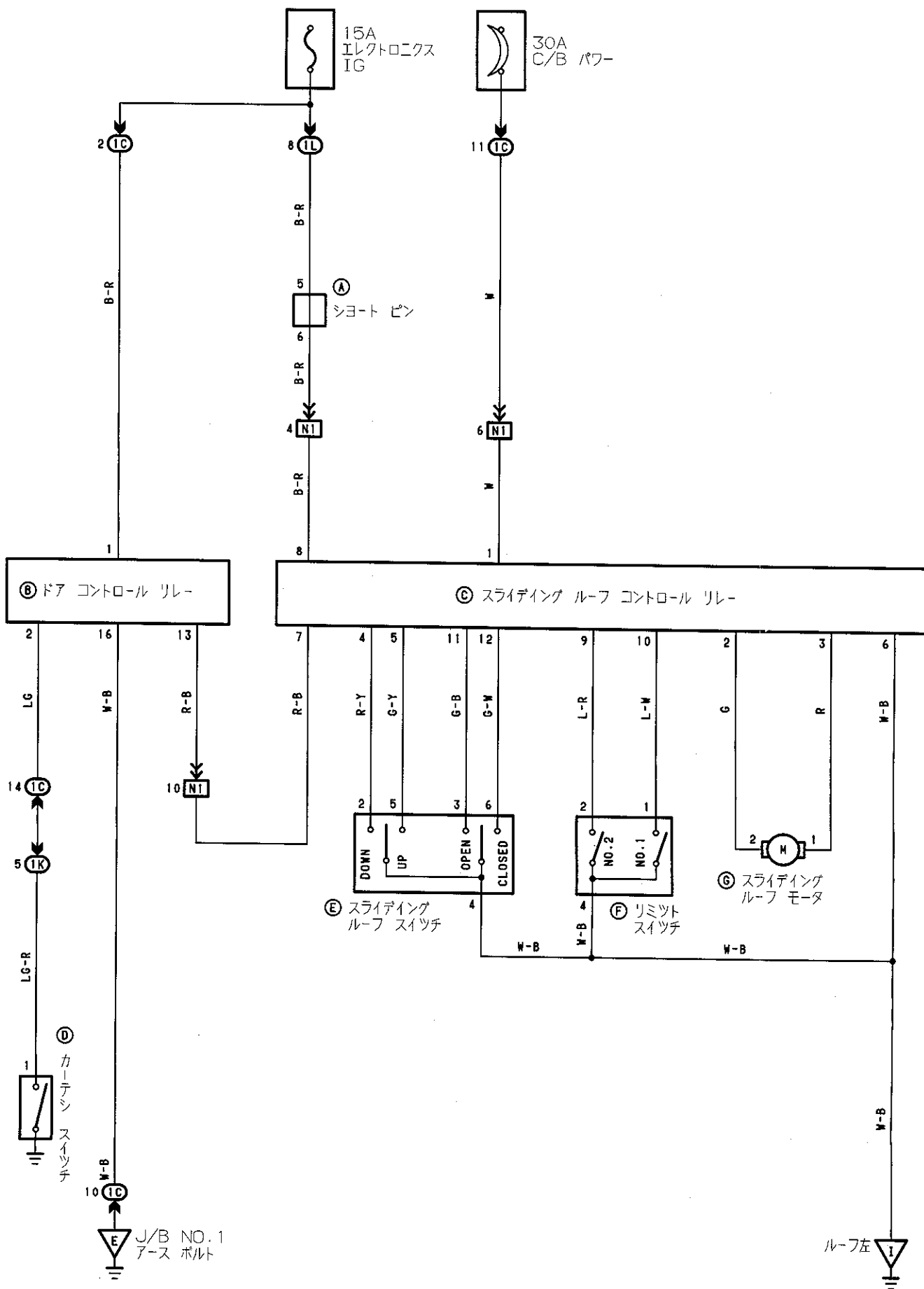

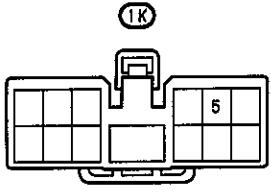
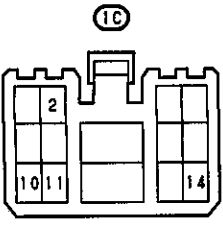
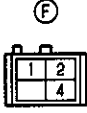
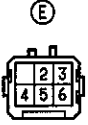
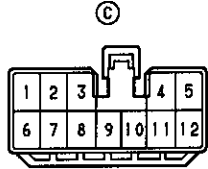
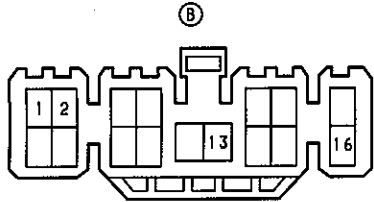
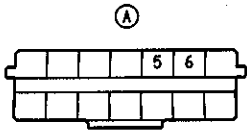

N1 だいだい色

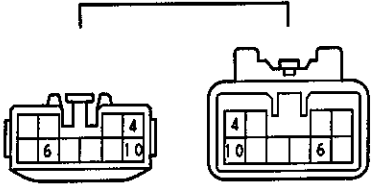



リヤ ウインドウ デイフオツガ

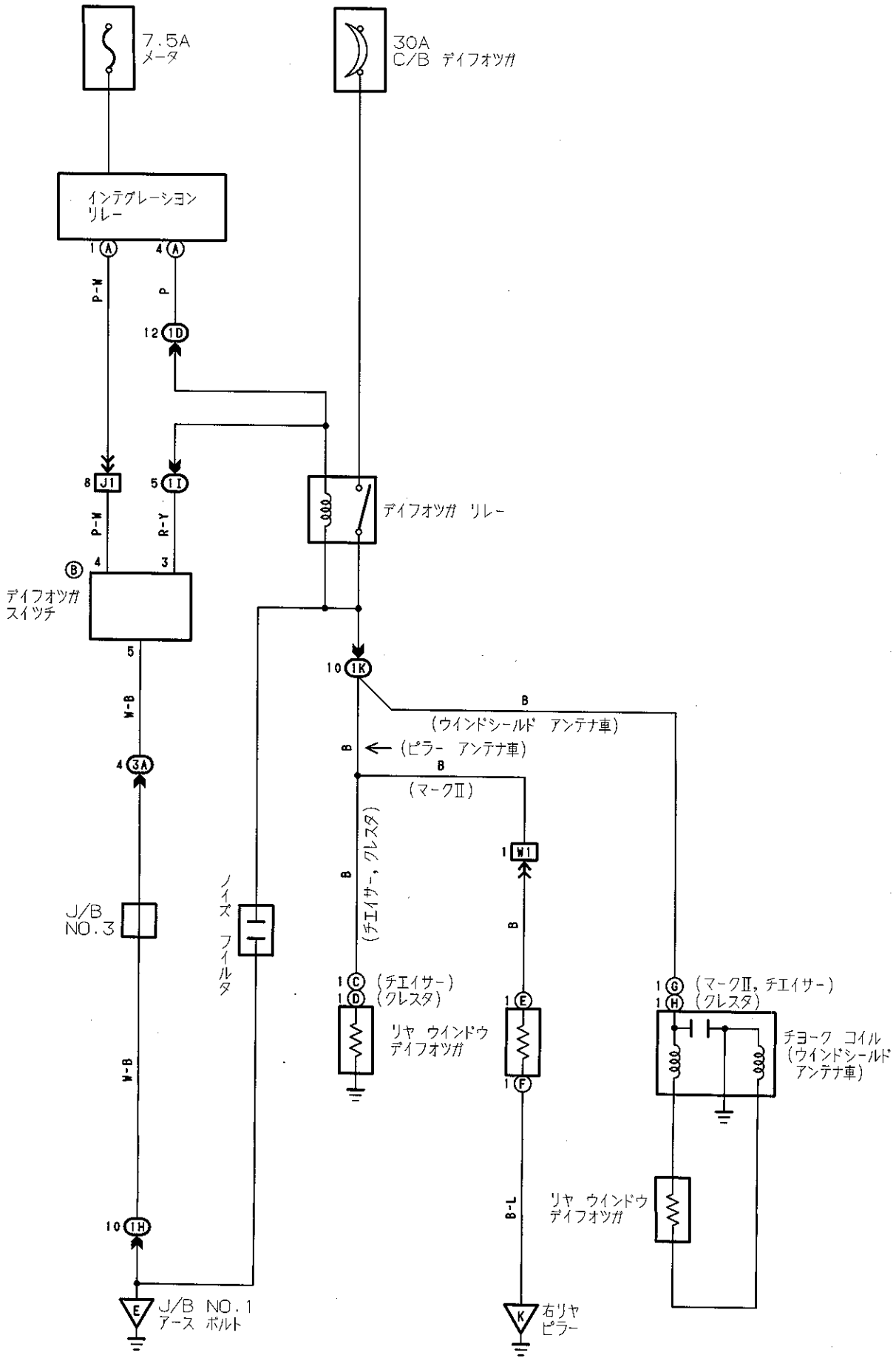

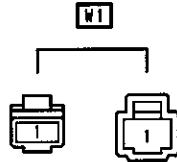
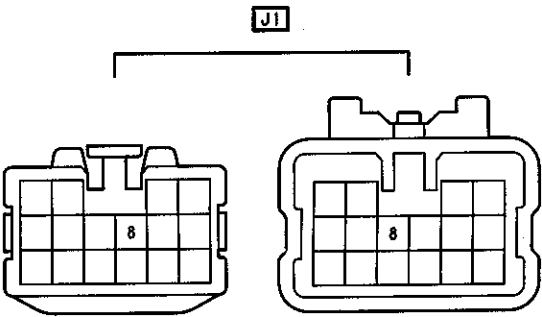
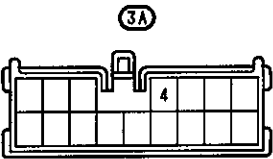
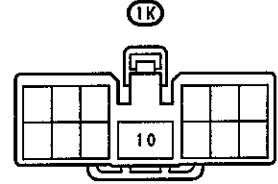
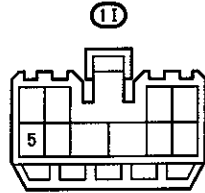
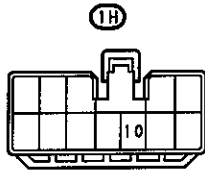
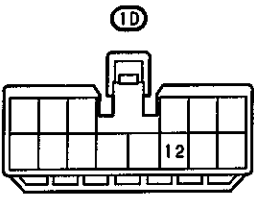
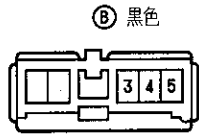
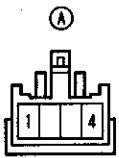

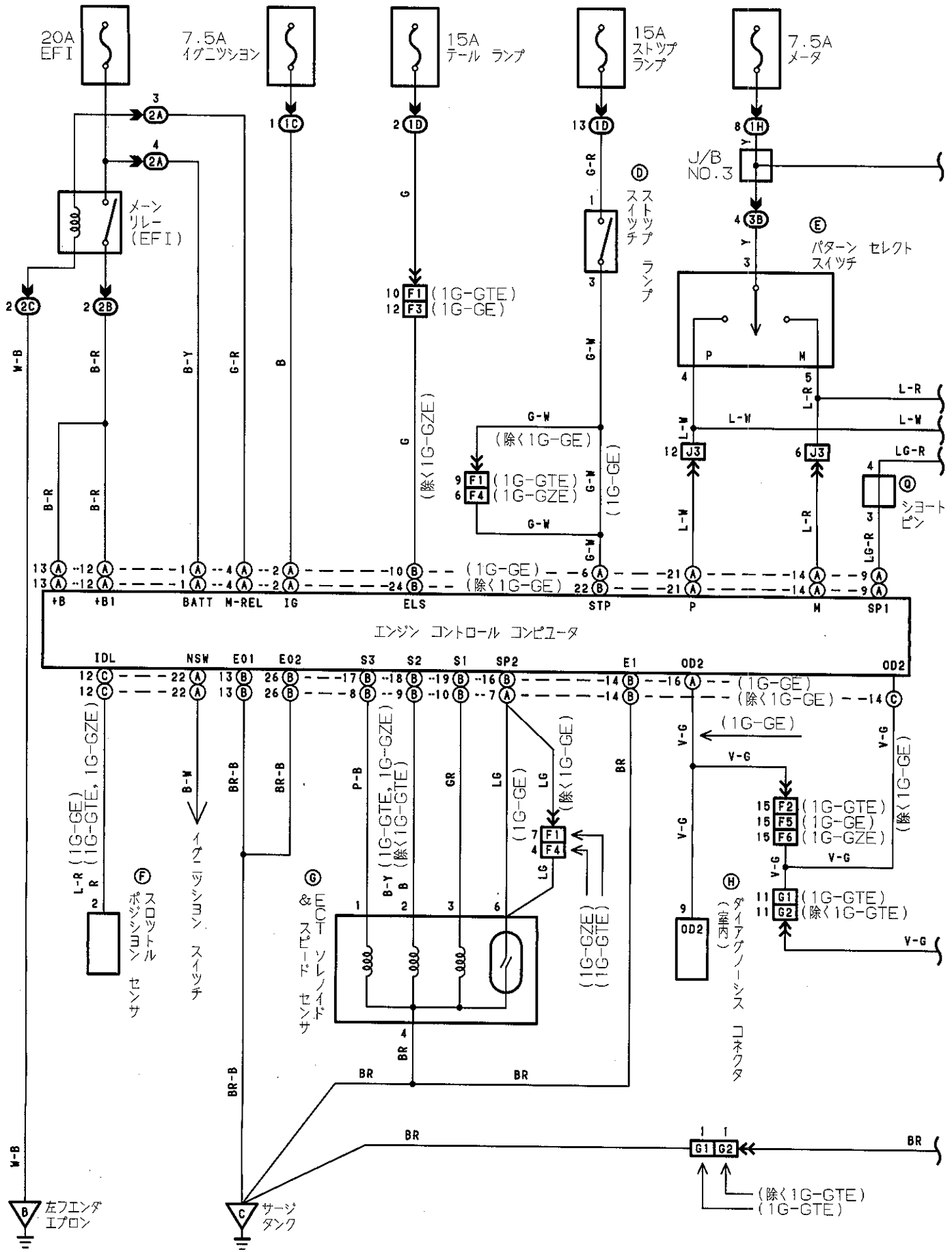

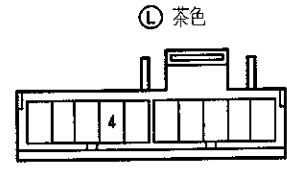
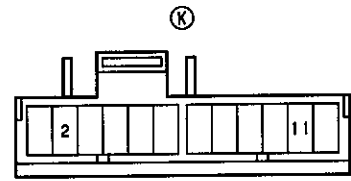
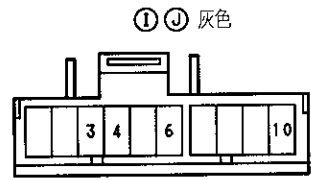
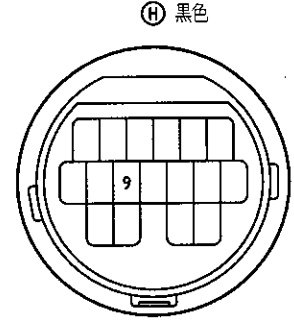
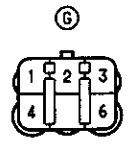
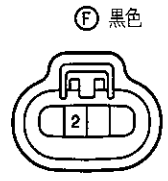
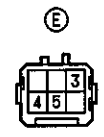
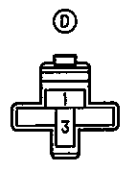
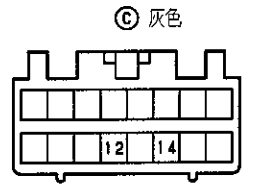
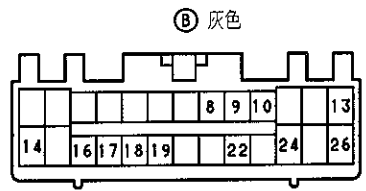
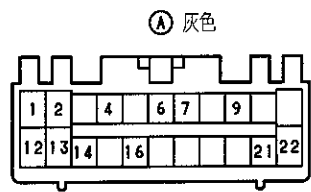
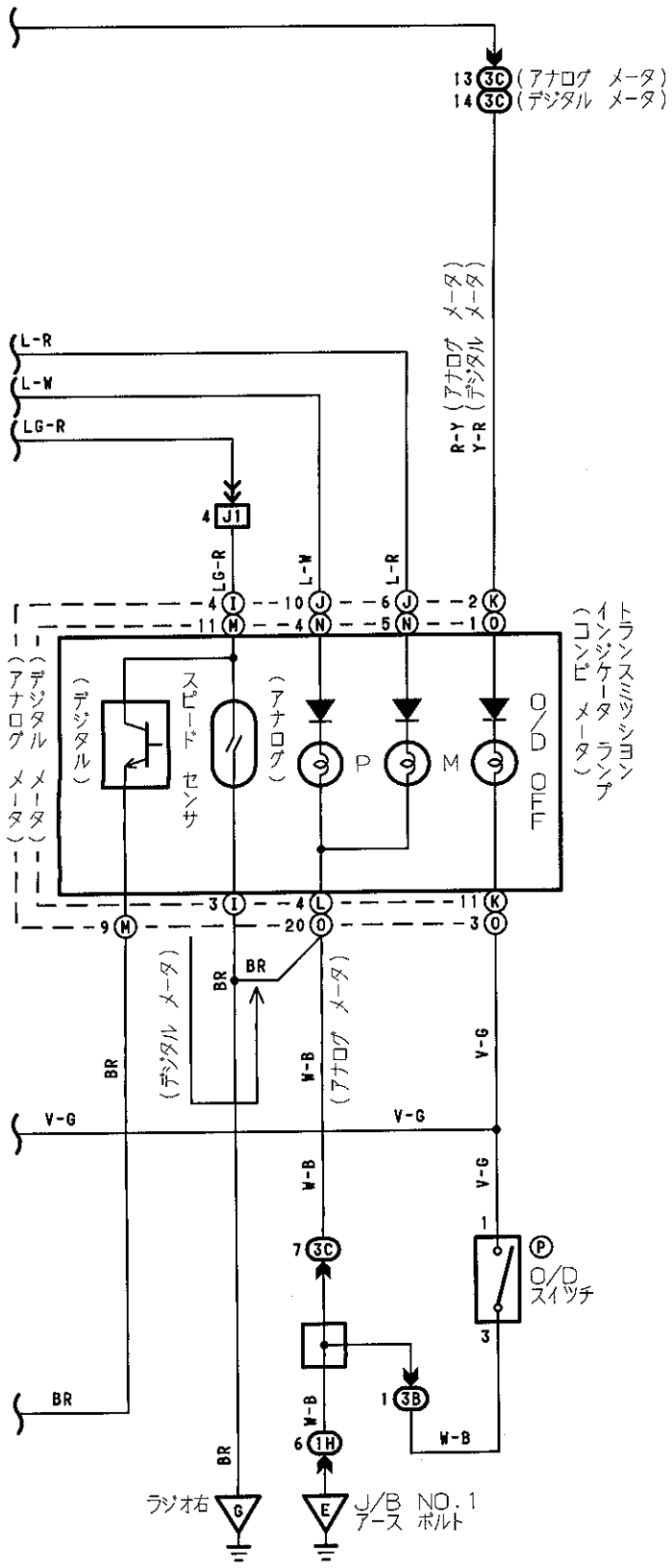

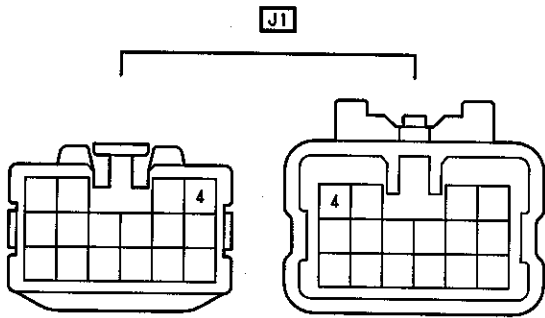
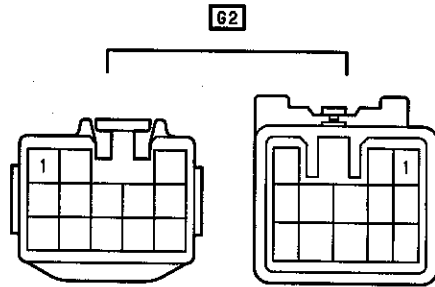
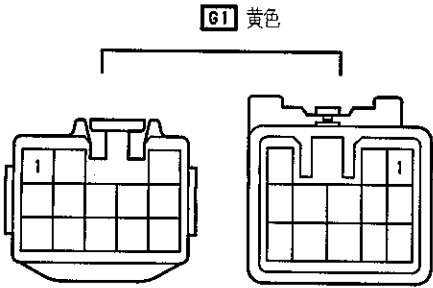
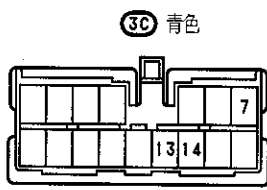
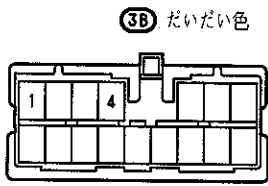
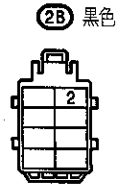
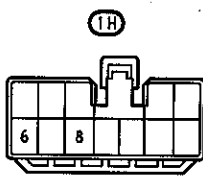
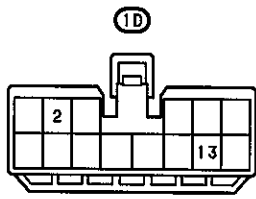
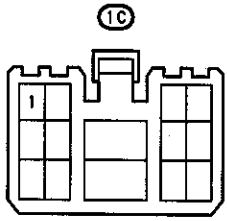
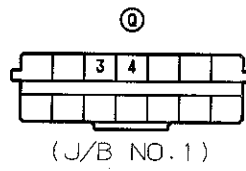
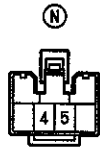
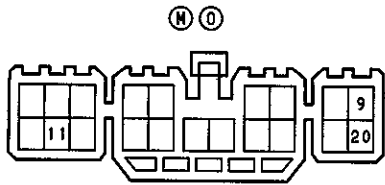

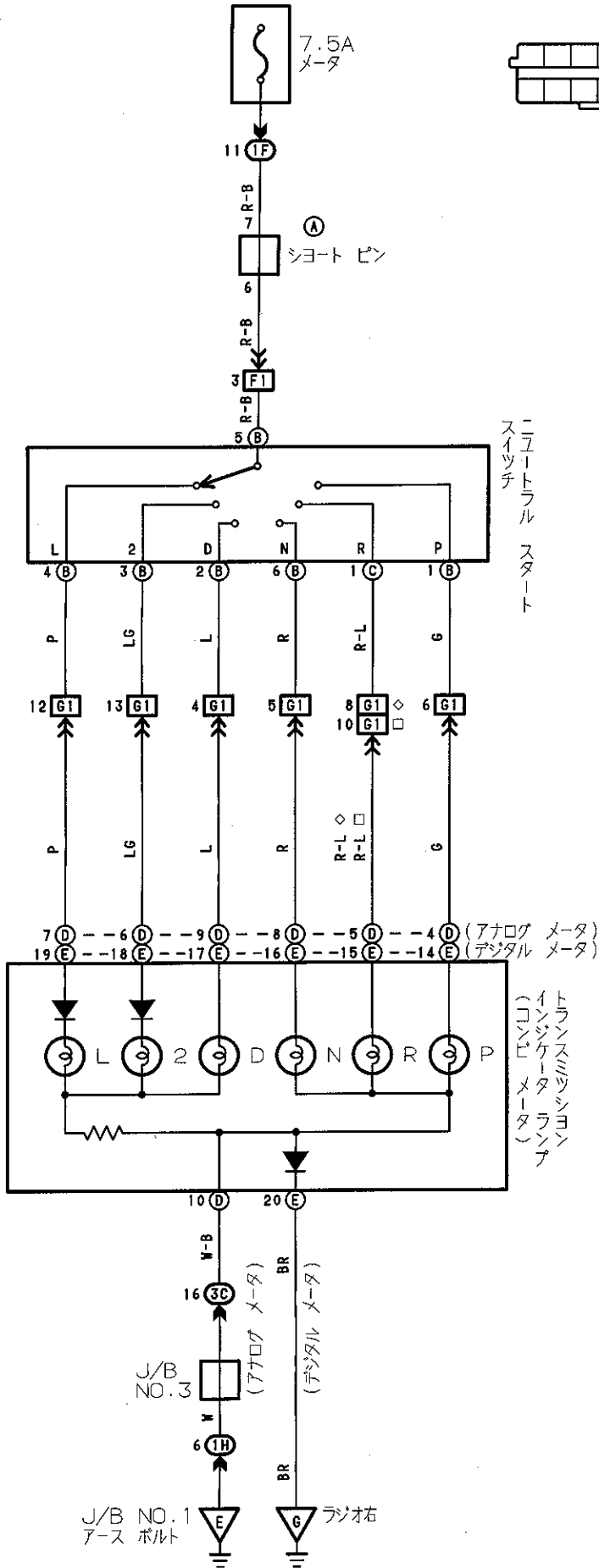

ニフットラル
スイッチ
スタート

トランスミッション
インジケータ
(コンピメータラヨン
メータ)

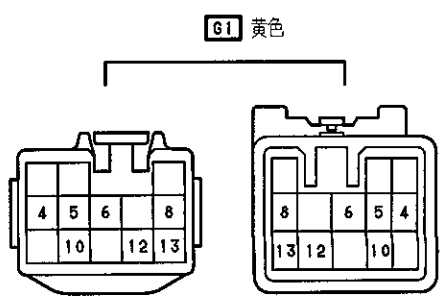
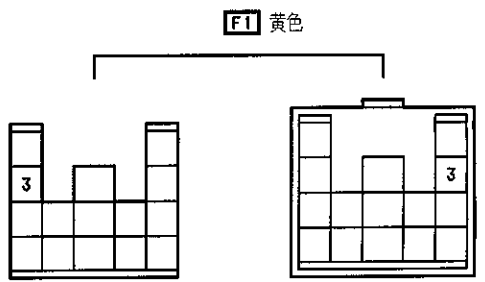
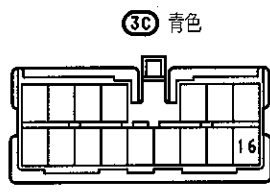
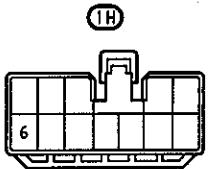
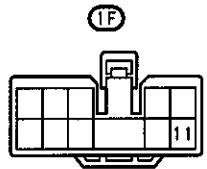
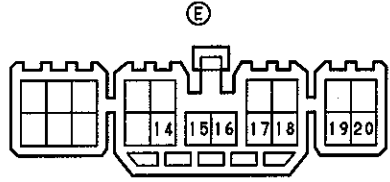
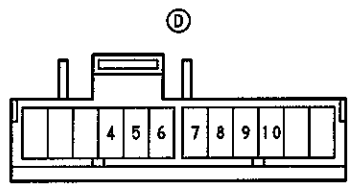
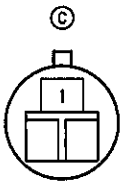
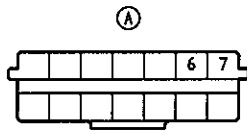

O/D オーバードライブ

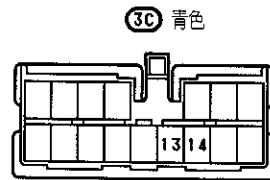
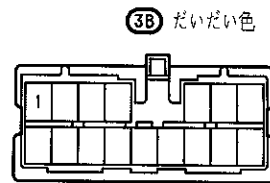
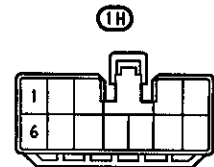
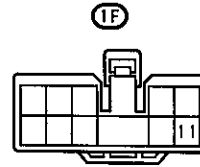
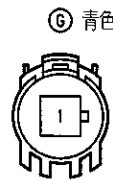
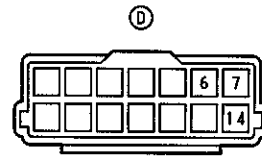
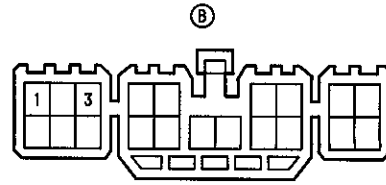
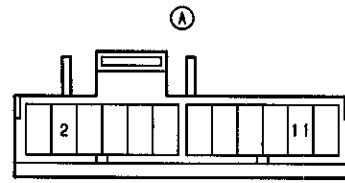
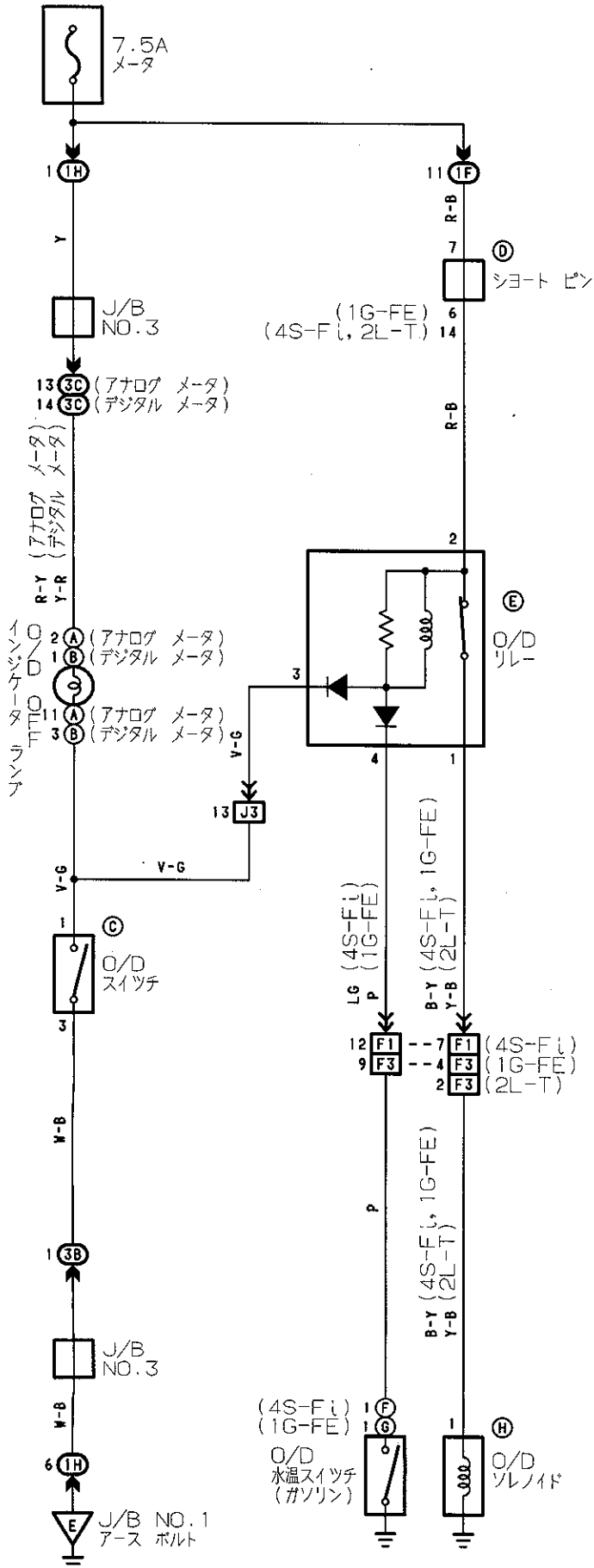

F1 黄色

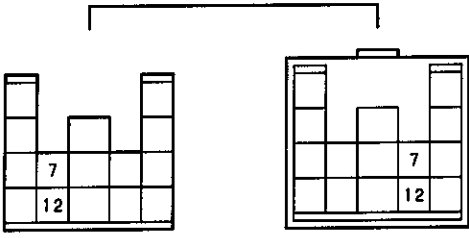

F3 灰色

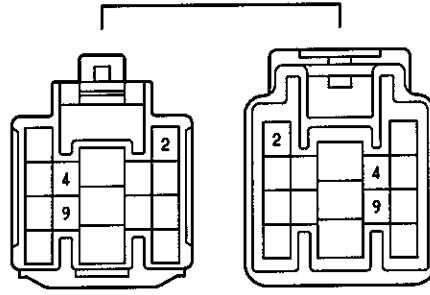

J3

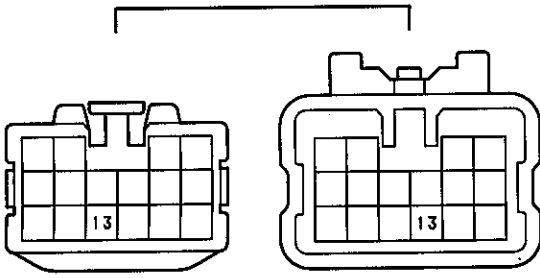



パワー ステアリング

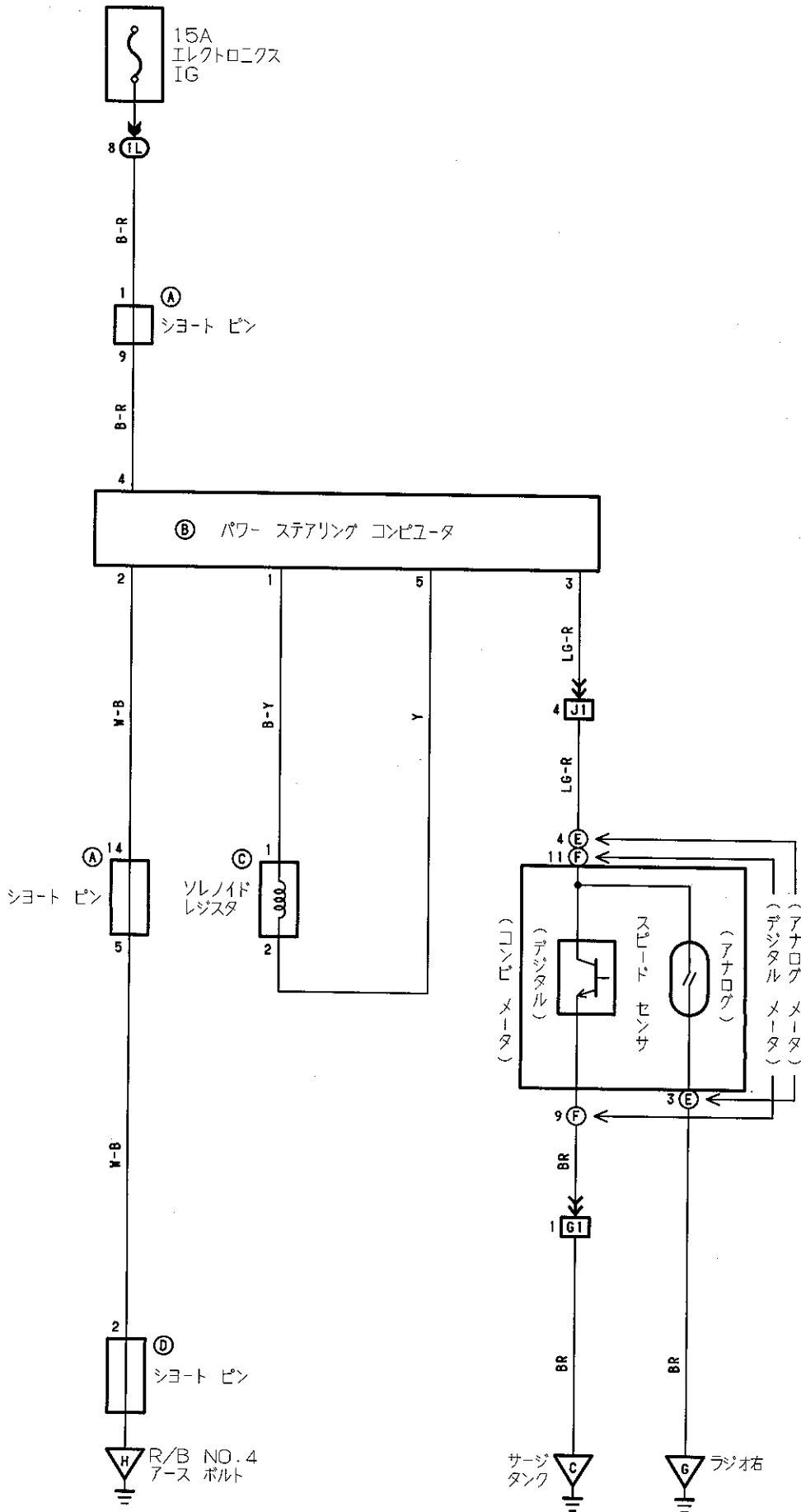

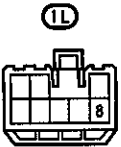
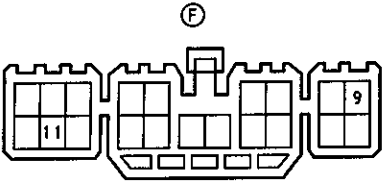
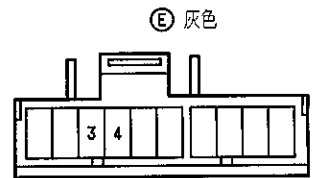
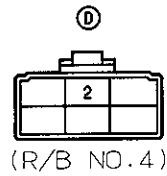
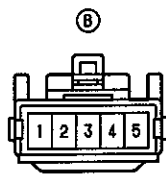
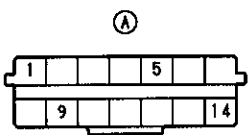

G1 黄色

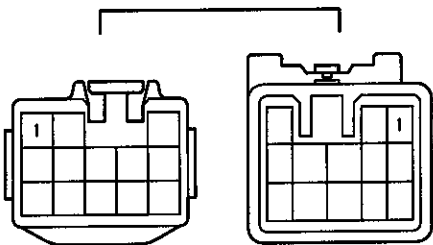

J1

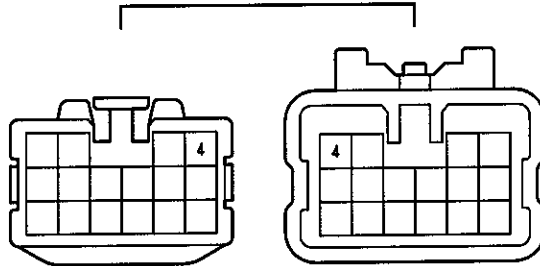

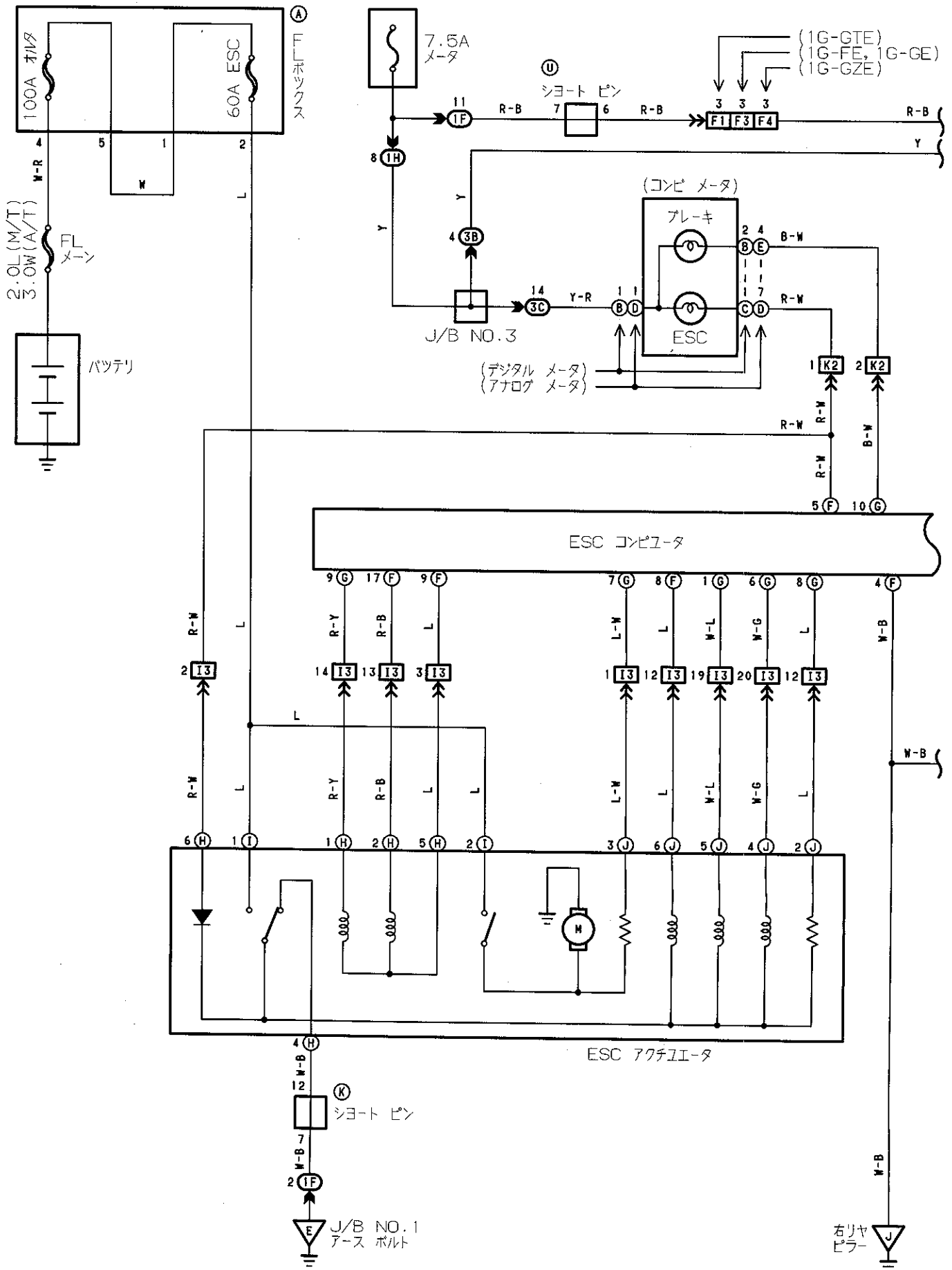

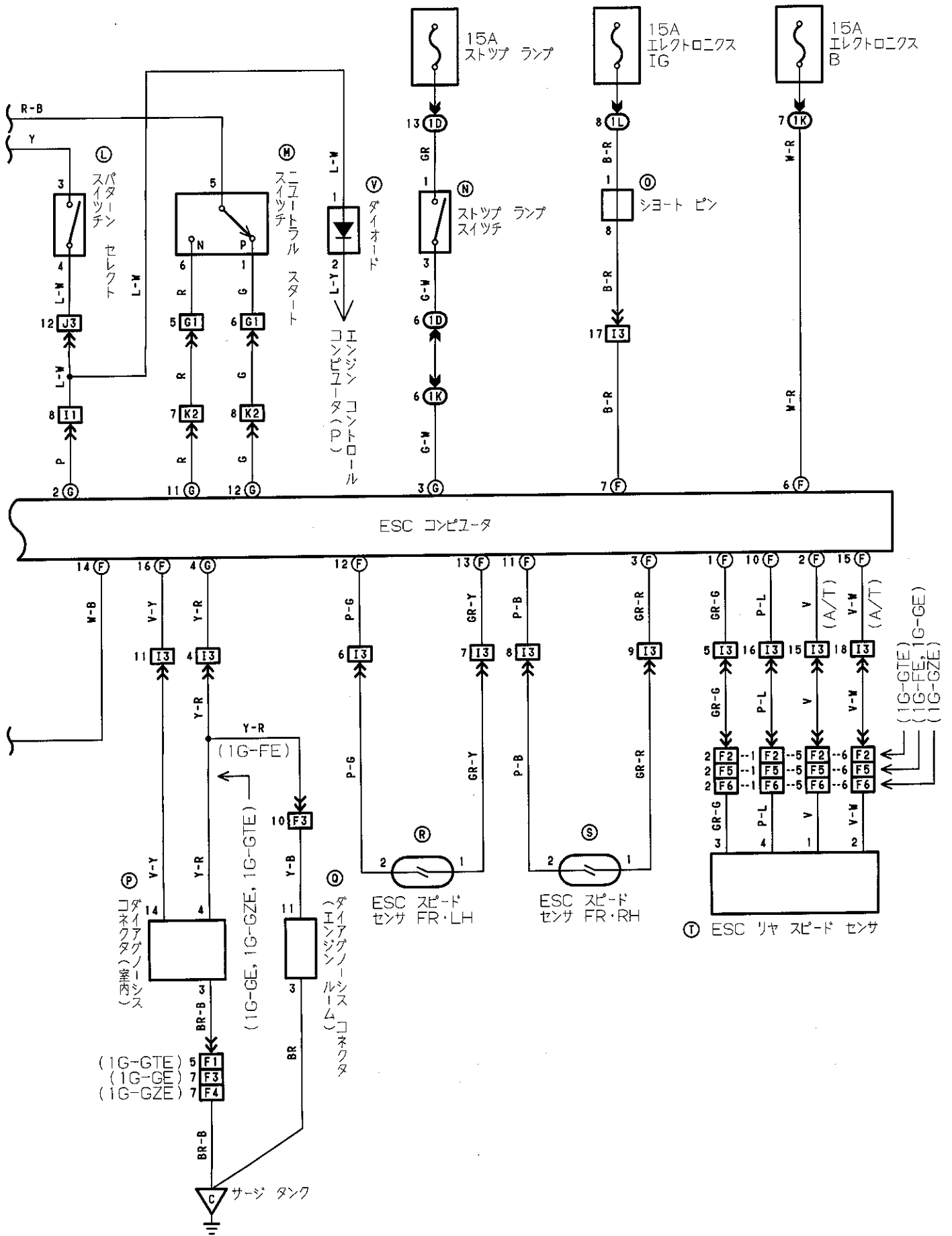

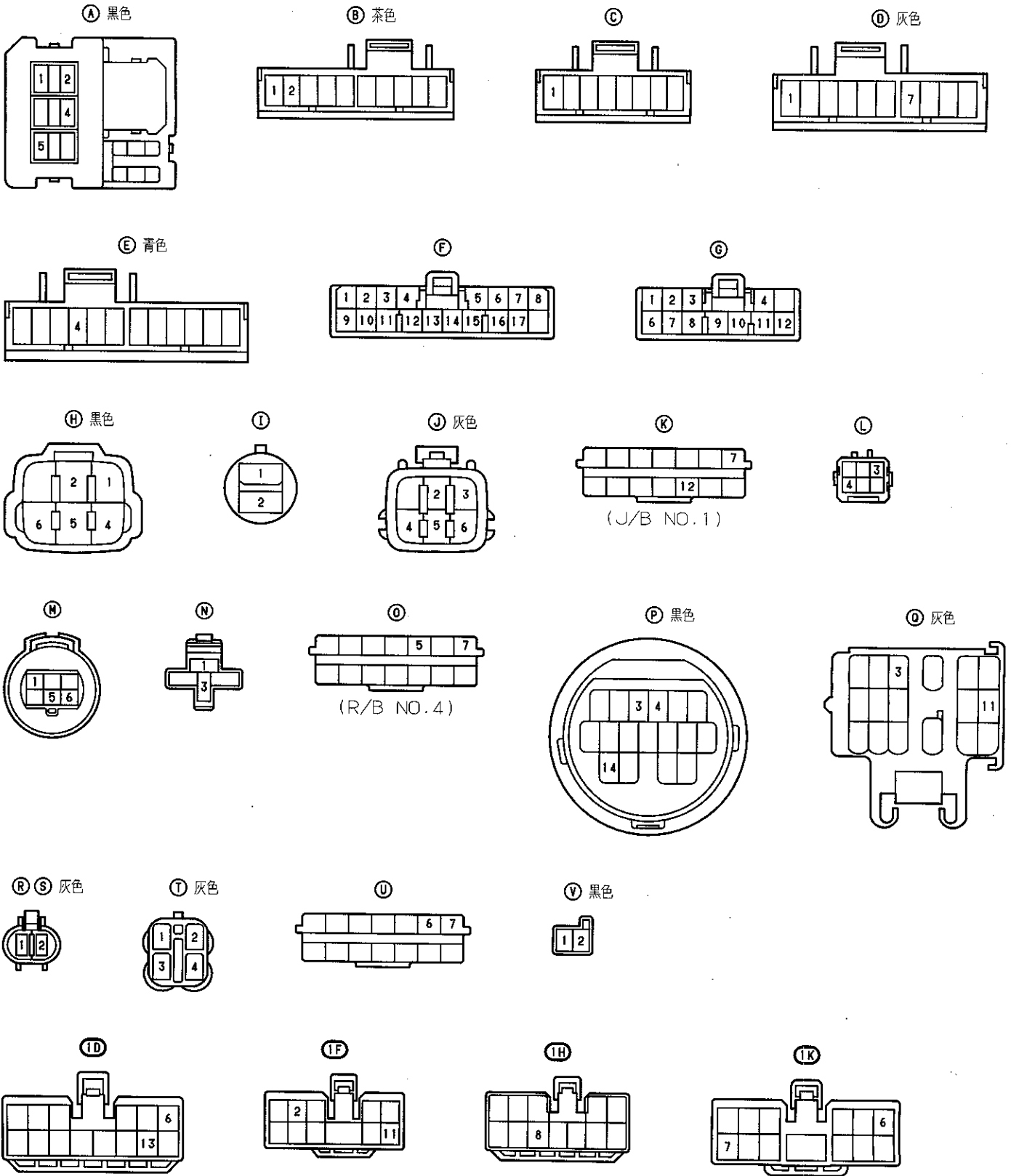

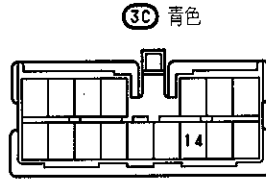
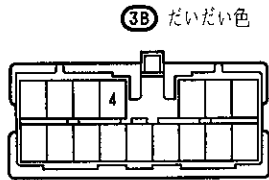
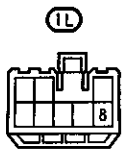

F1 黄色

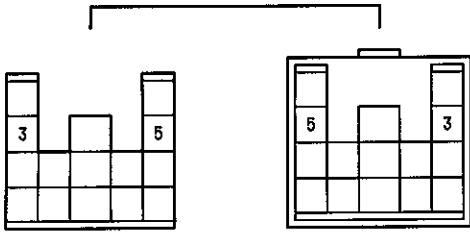

F2 黄色

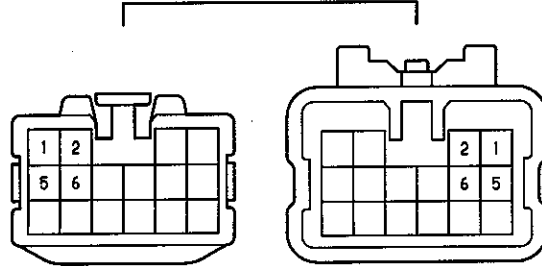

F3 灰色

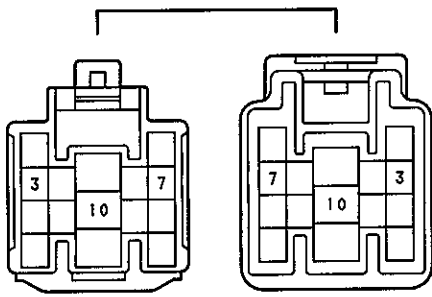

F4

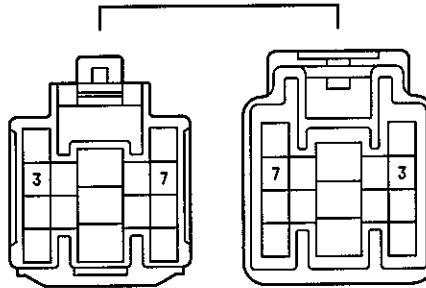

F5 灰色

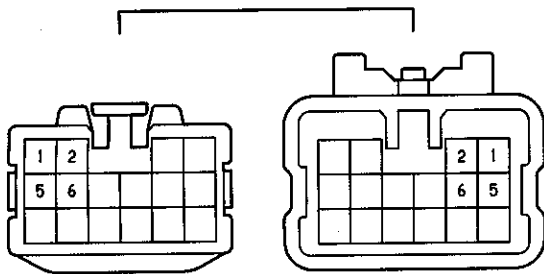

F6 J3

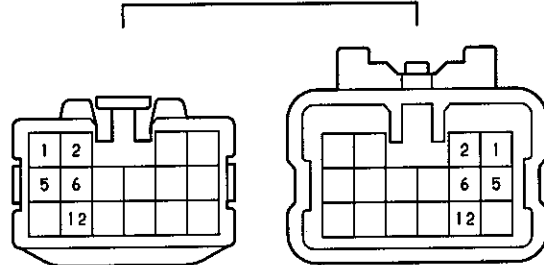

G1 黄色

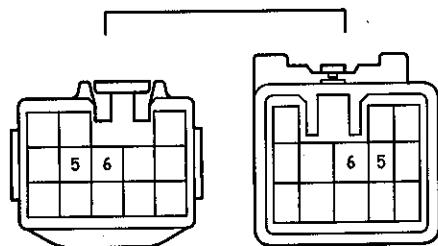

I1 灰色

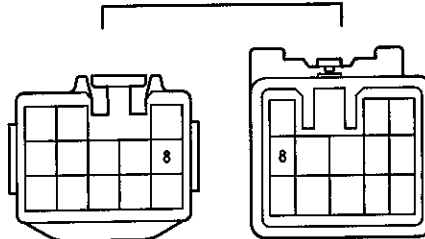

I3

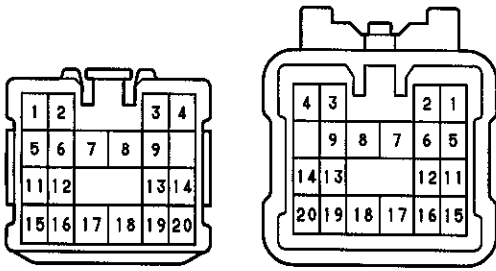

K2

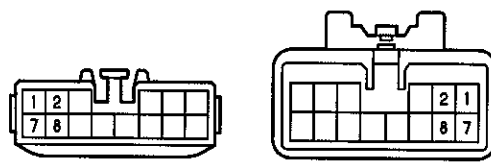

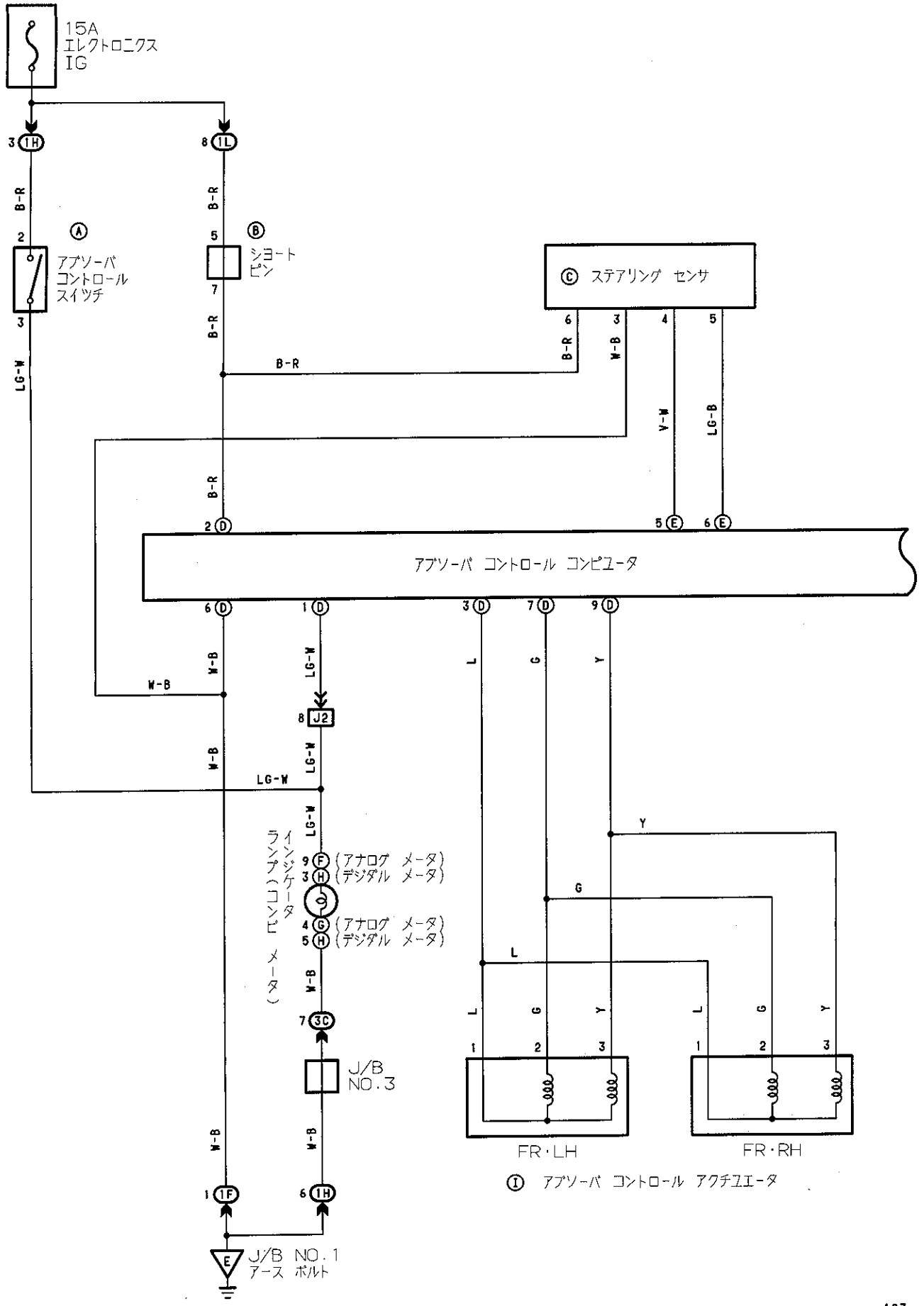

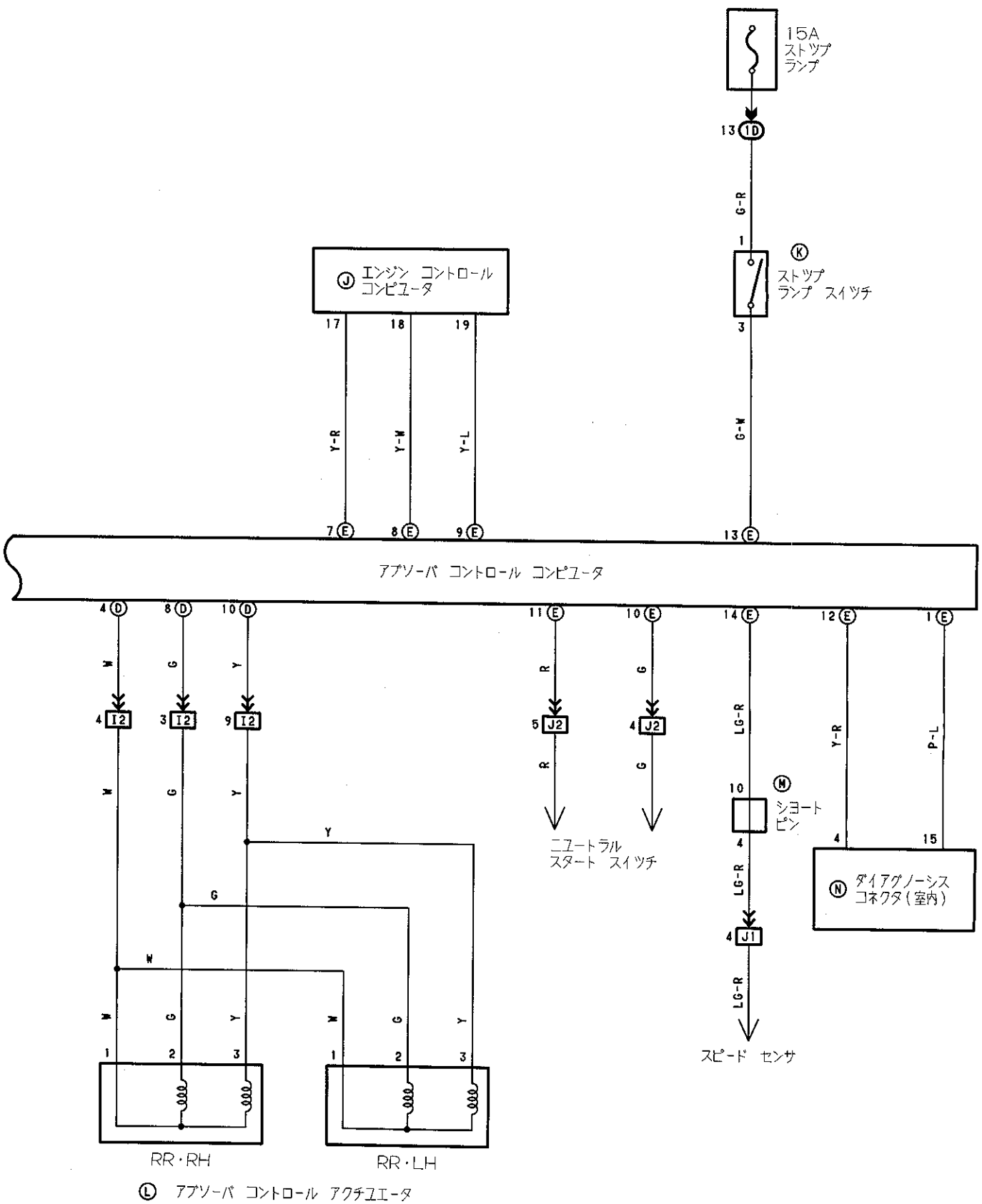
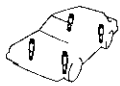

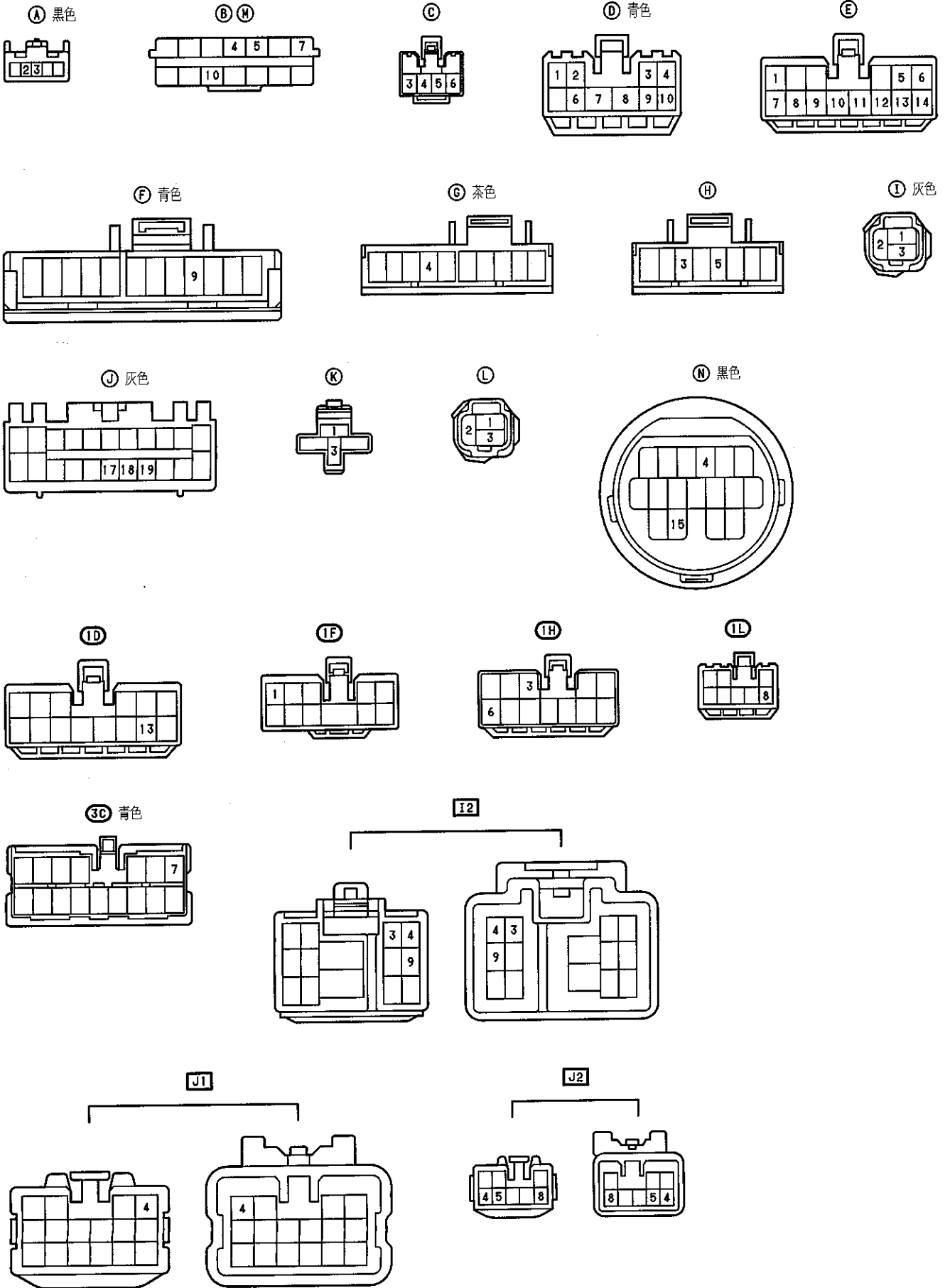

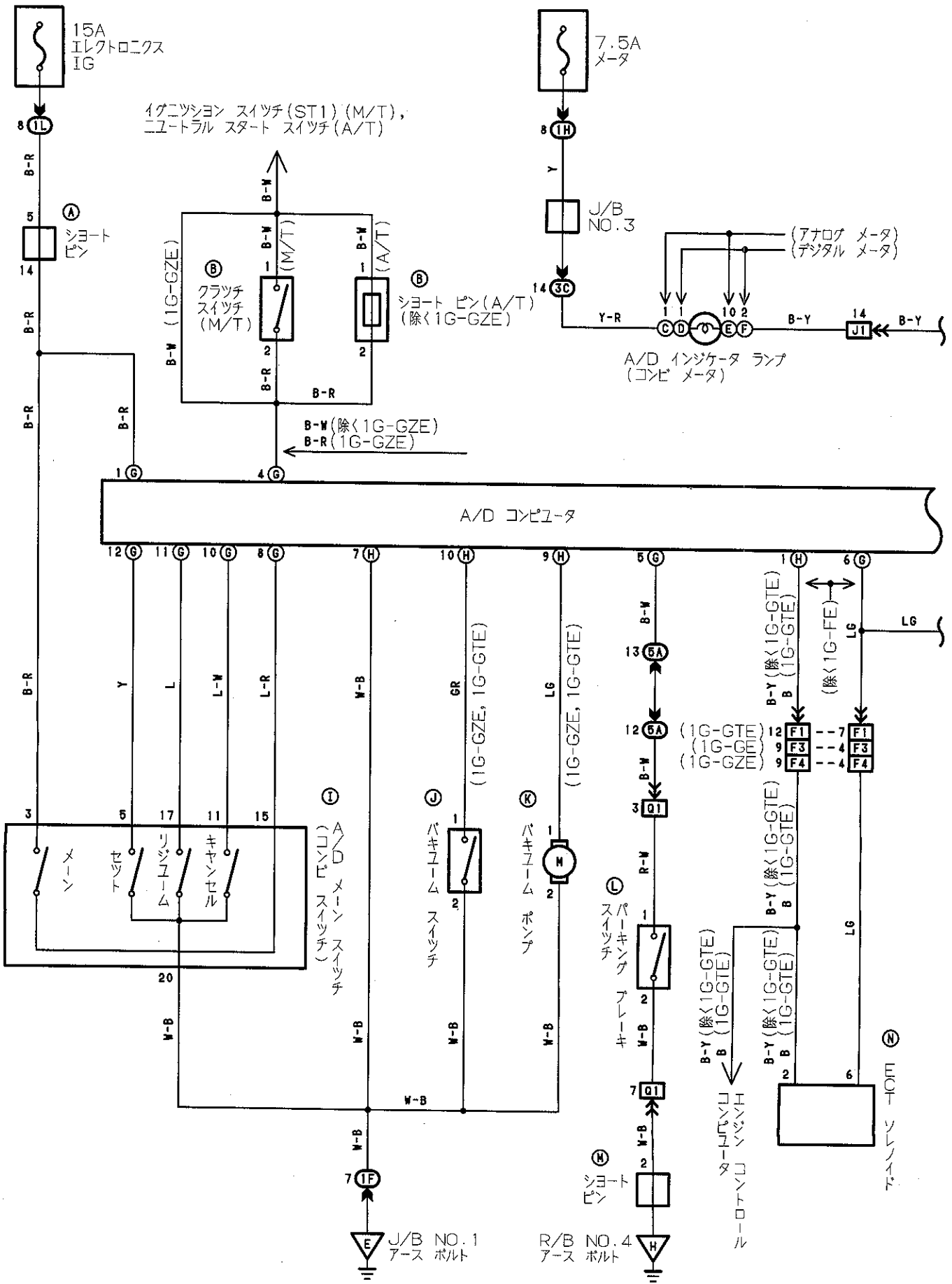

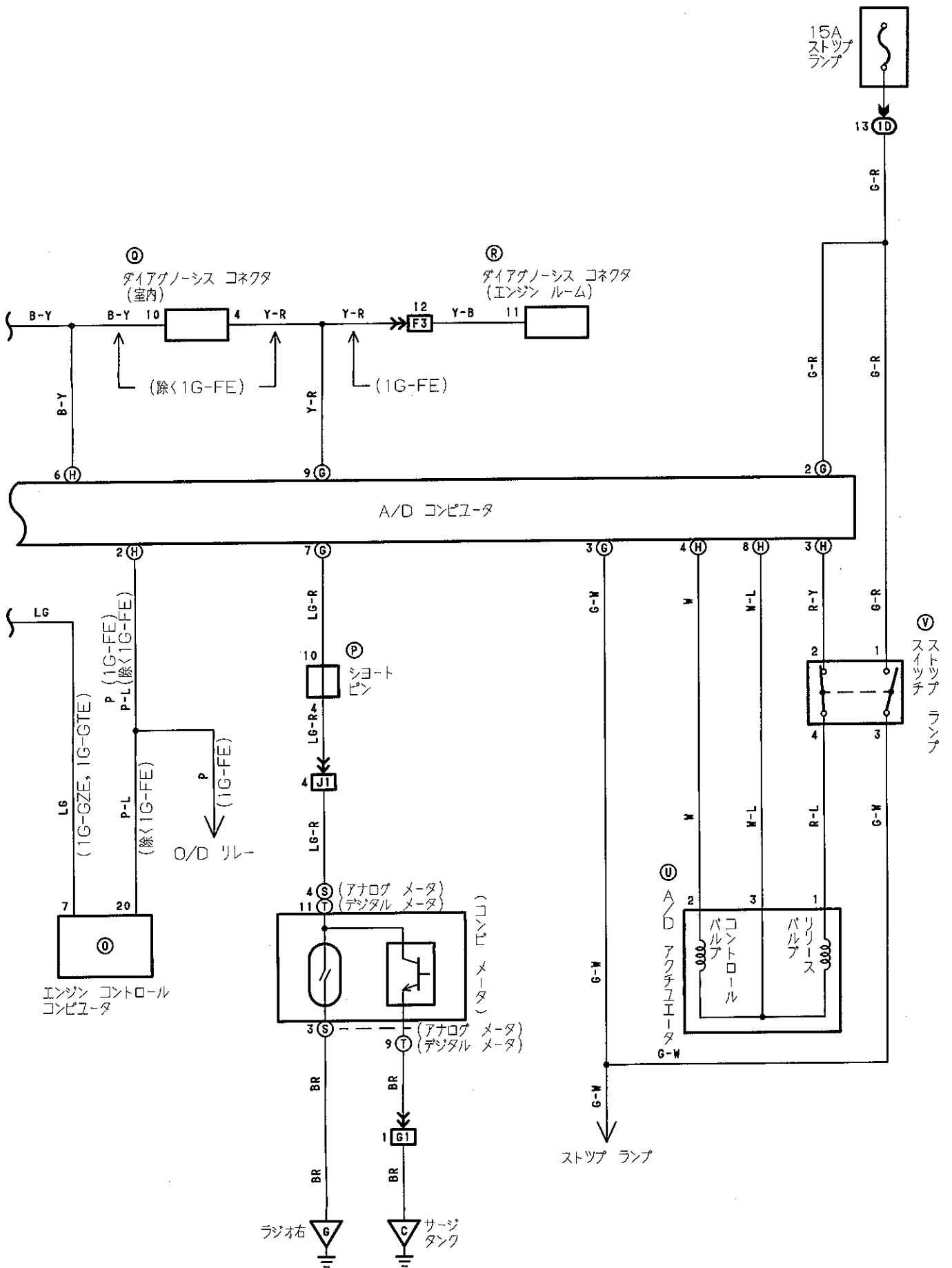

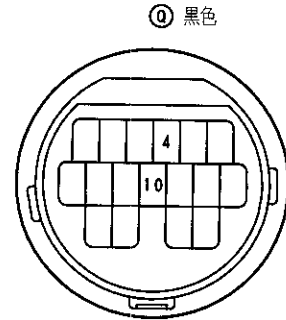
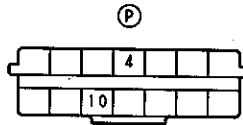
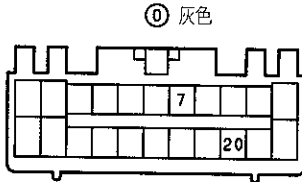
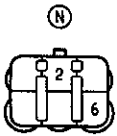
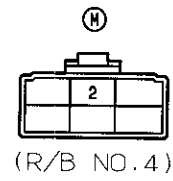
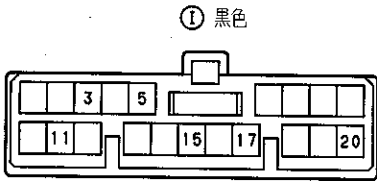
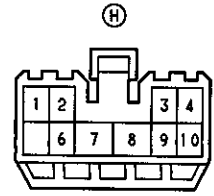
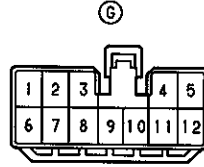
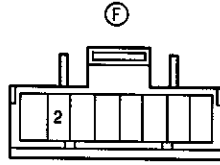
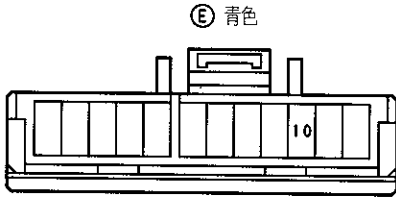
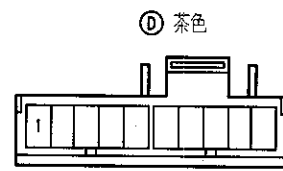
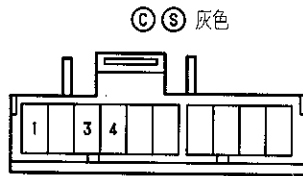
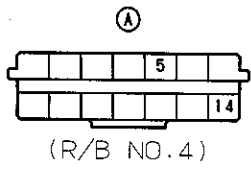

(J/B NO.1)

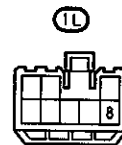
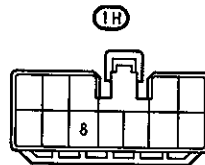
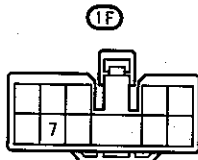
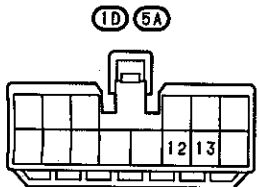
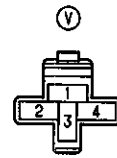
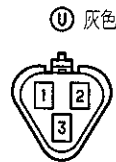
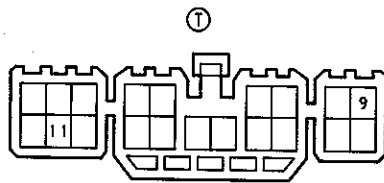
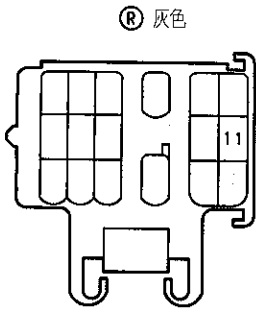

3C 青色

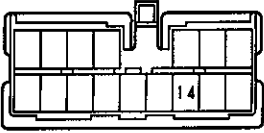

F1 黄色

F3 灰色

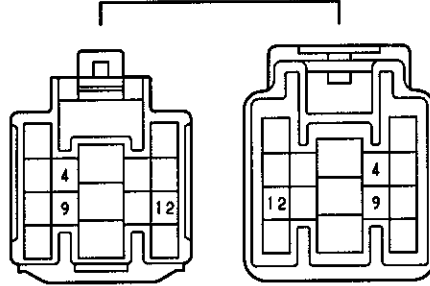
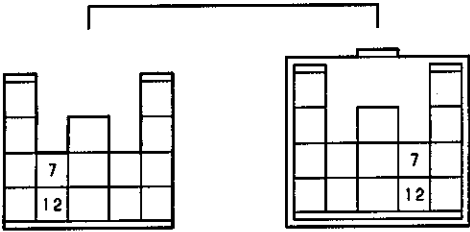

F4

G1 黄色

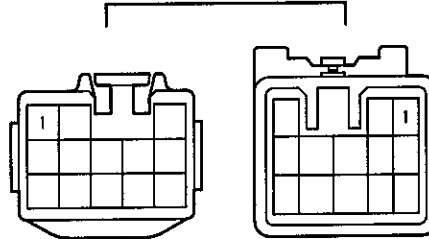
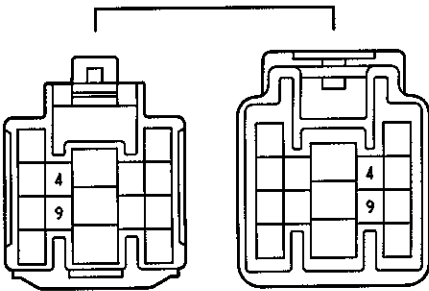

J1

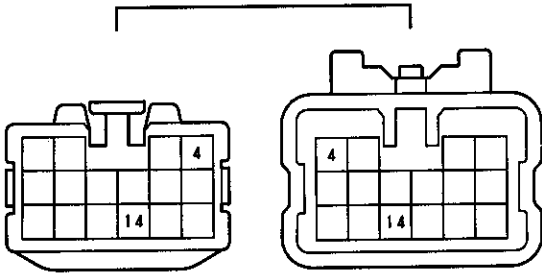

Q1

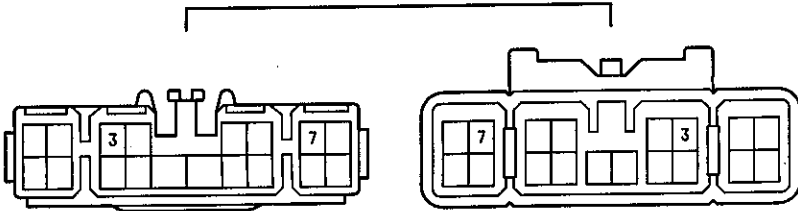

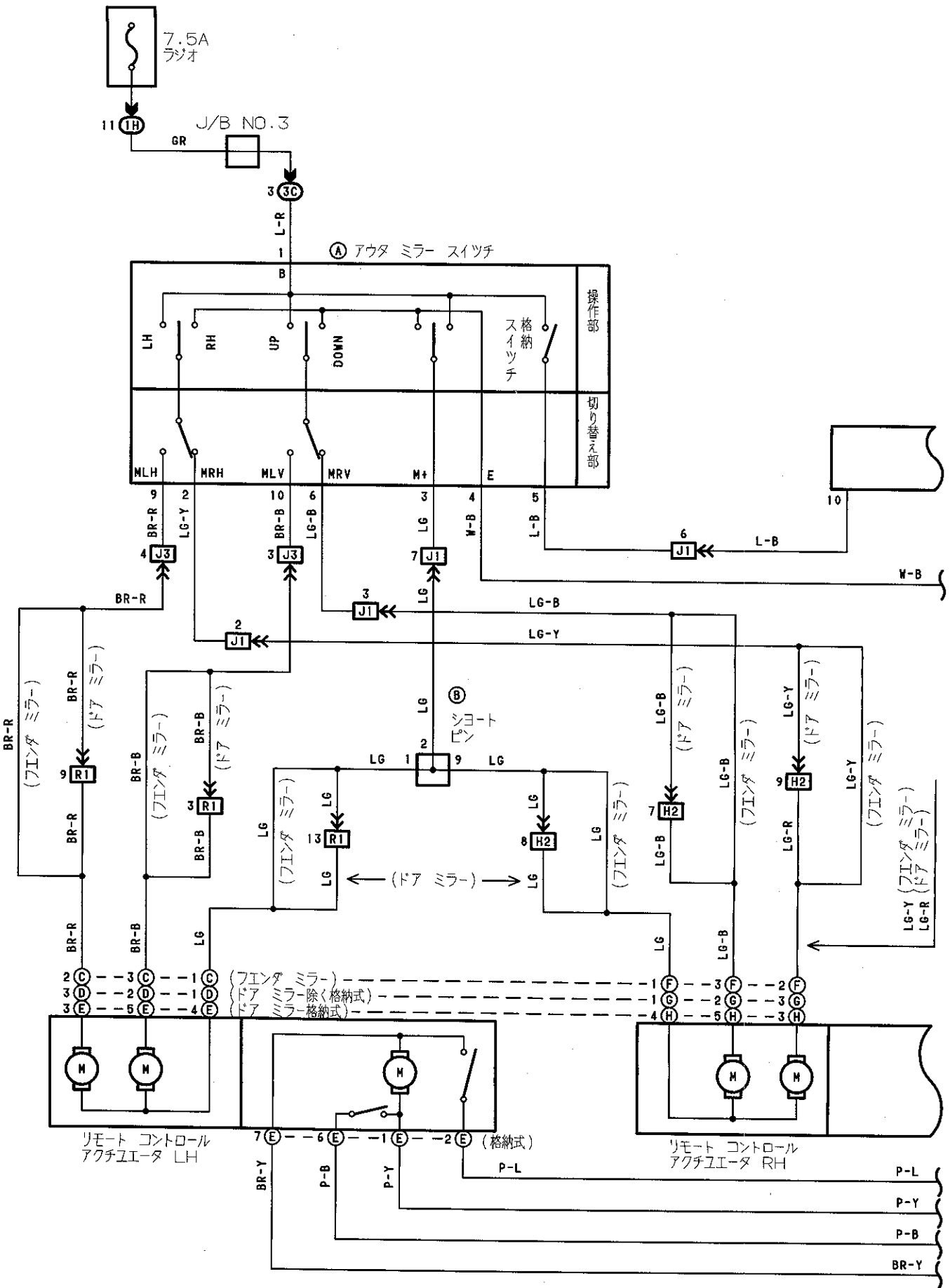

15A
 エレクトロニクス +B

5 (1F)

W-R

9

① ミラー コントロール リレー

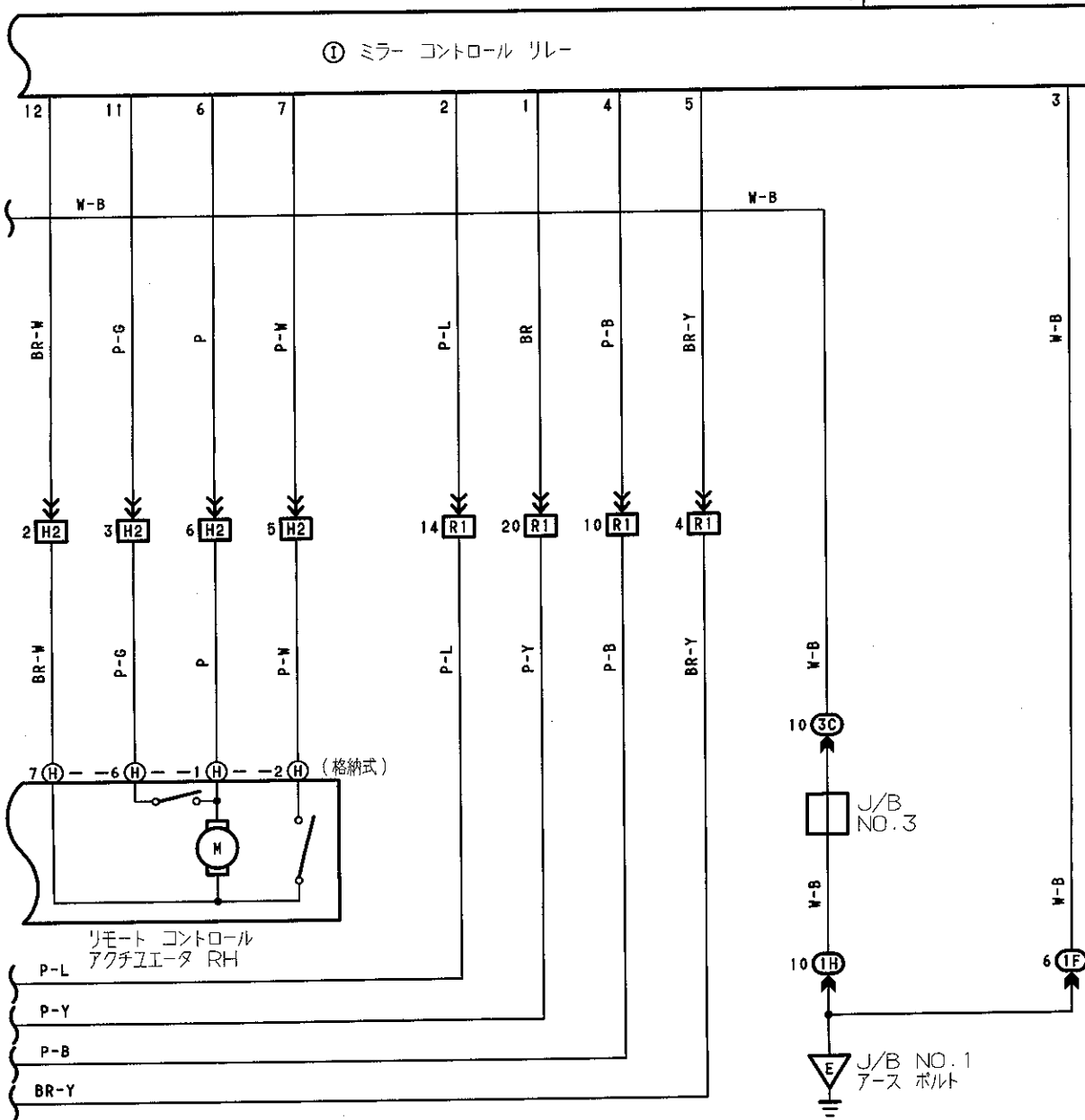

Ⓐ 青色

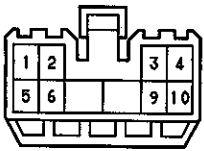

Ⓑ



Ⓒ Ⓕ



Ⓓ Ⓖ



Ⓔ Ⓗ

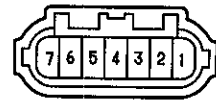

Ⓘ

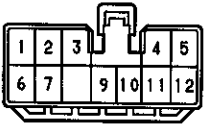

Ⓛ

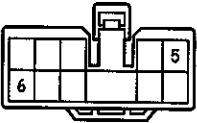

Ⓜ

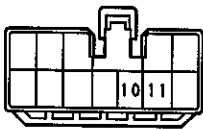

Ⓝ 青色

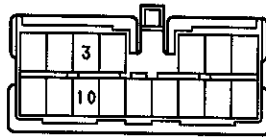

ⓗ2 青色

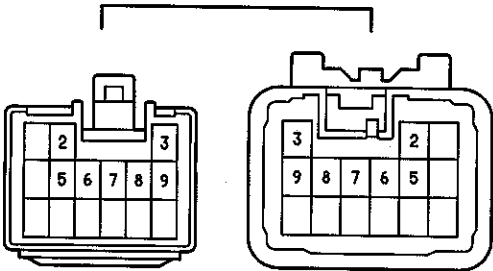

ⓙ1 ⓙ3

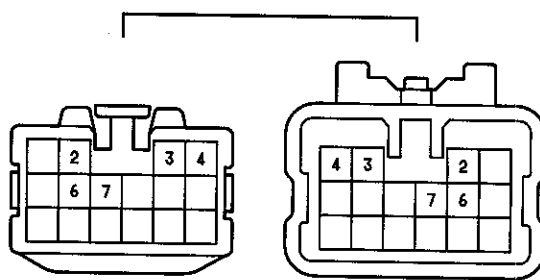

Ⓡ1 青色

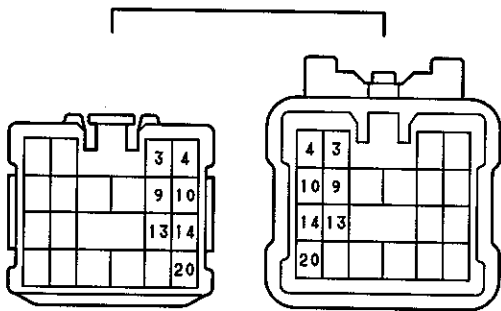

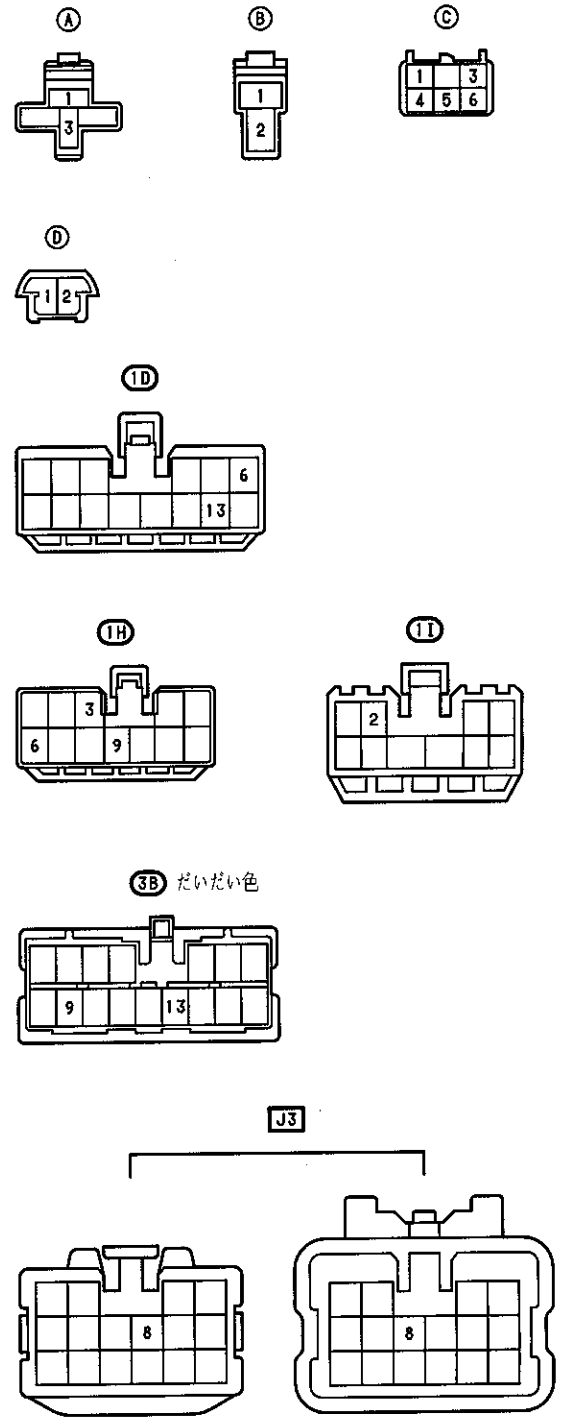
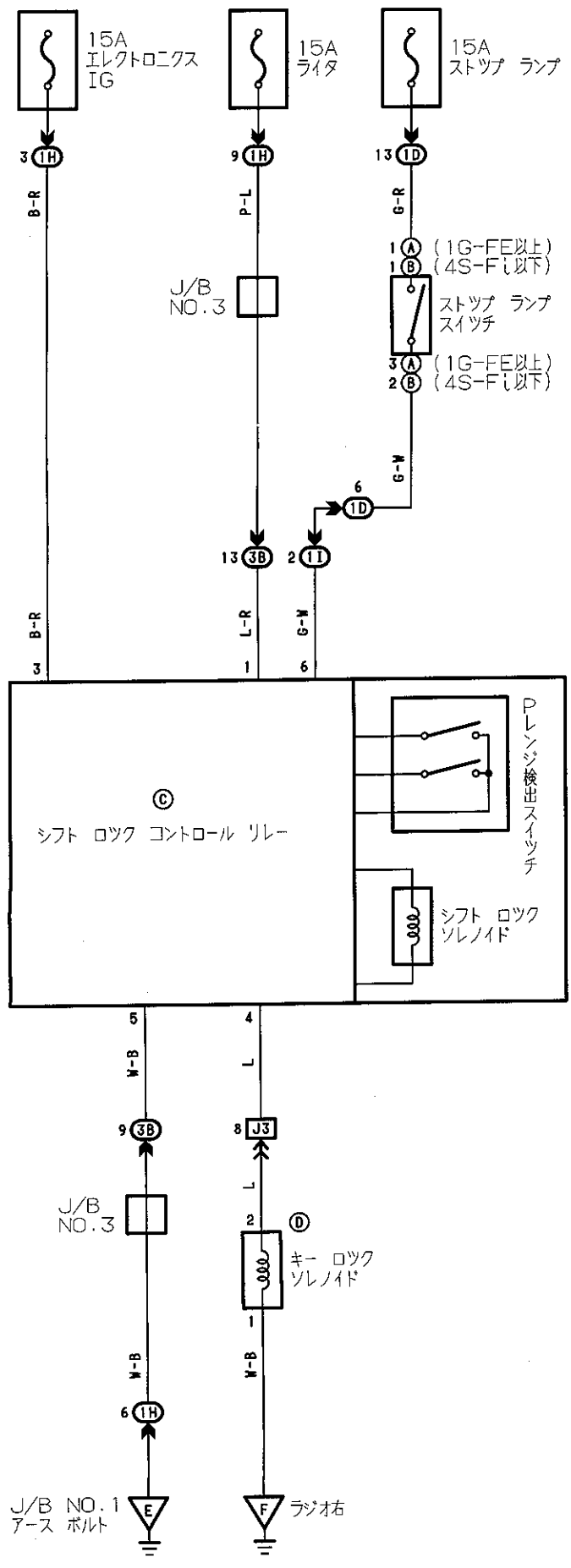



クリアランス ソナー

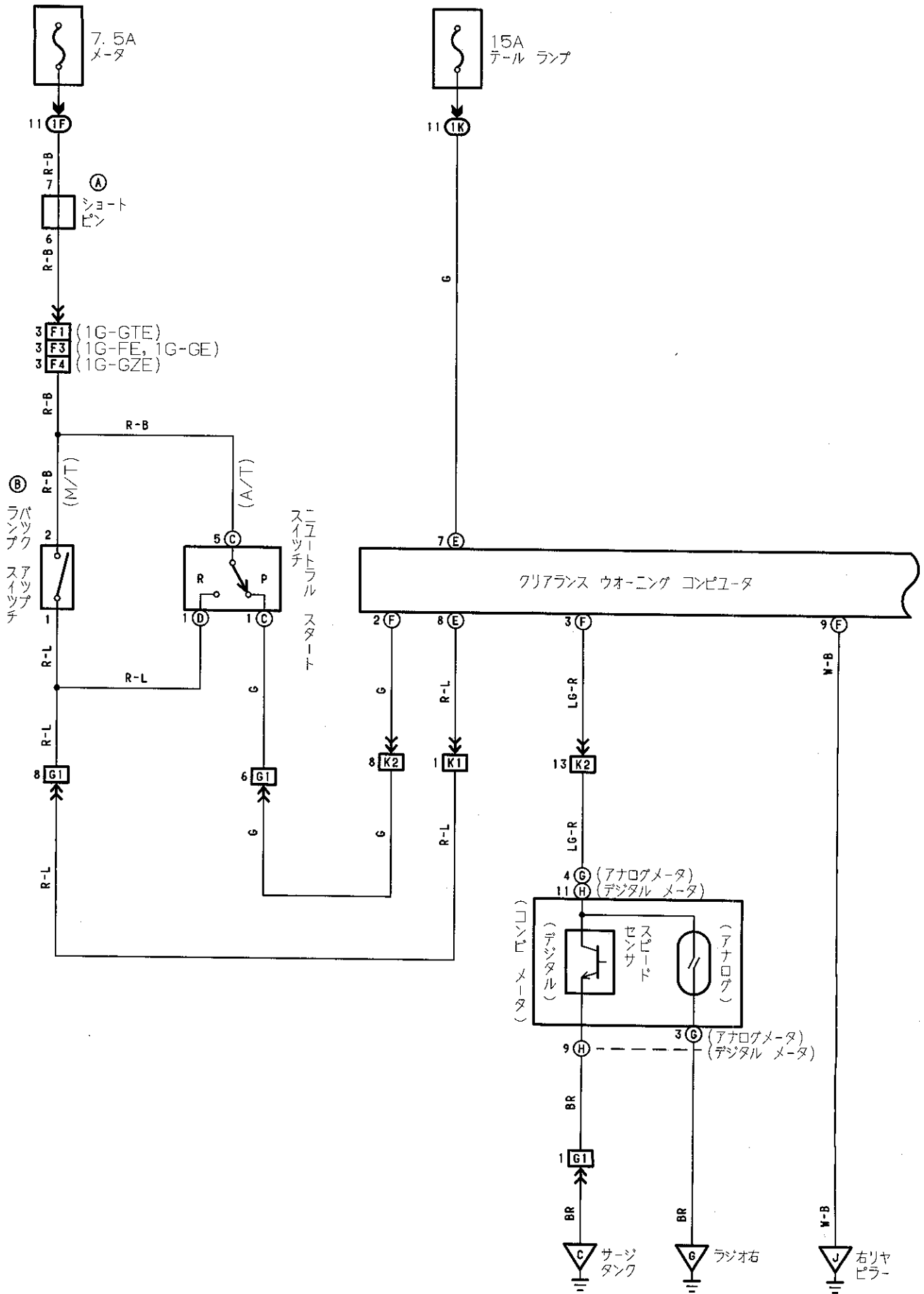

15A
 イレクトロノクス
 IG

11 (IK)

B-R

① クリアランス ウォーニング
 ディスプレイ

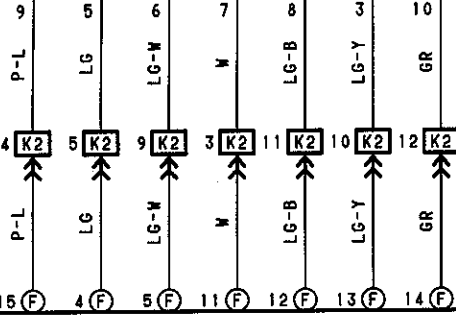

クリアランス ウォーニング コンピュータ

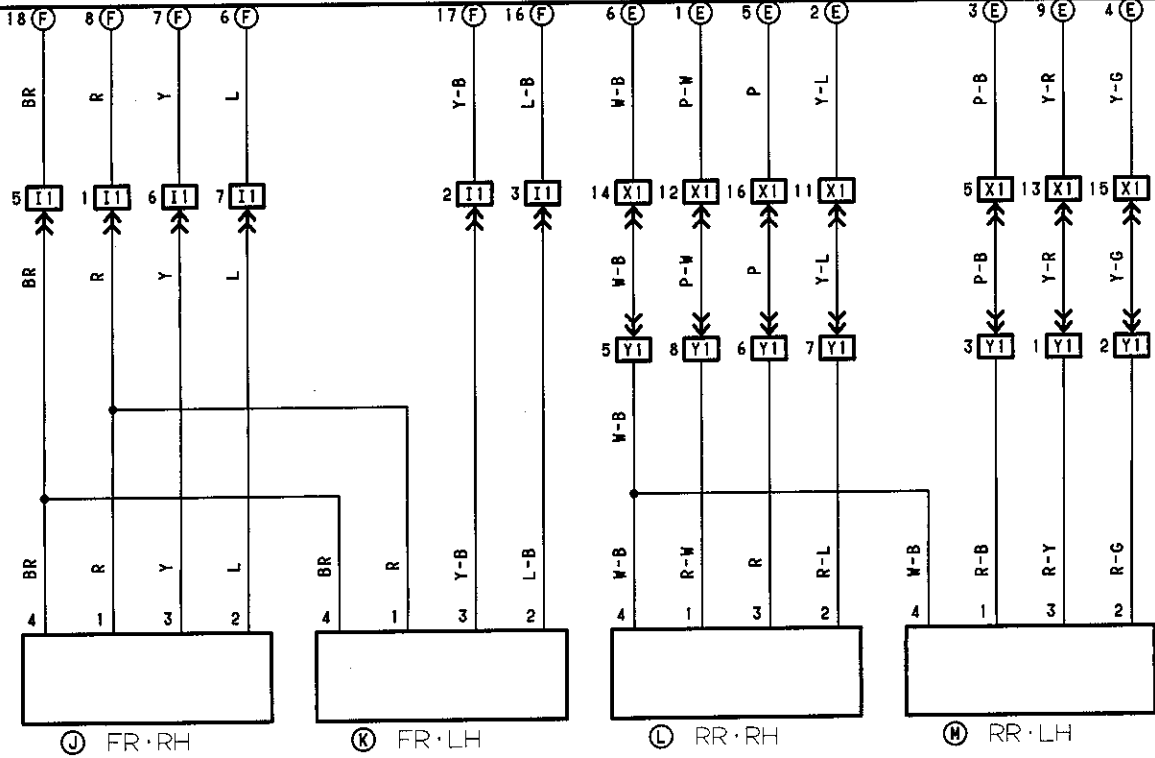

クリアランス センサ

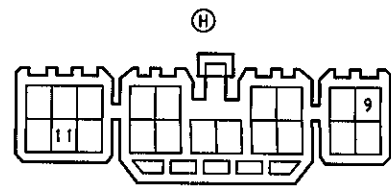
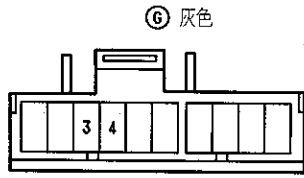
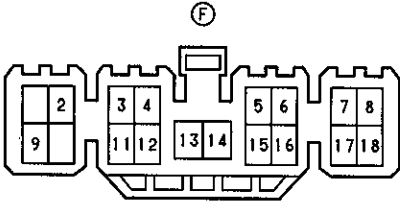
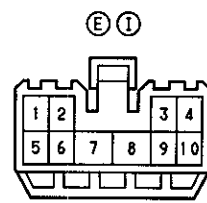
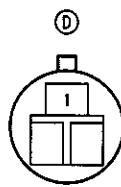
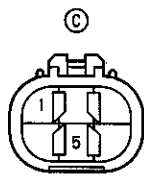
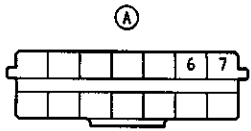

J K L M

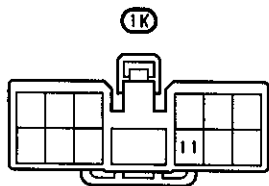
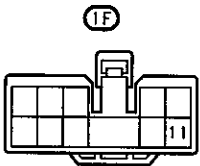
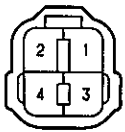

F1 黄色

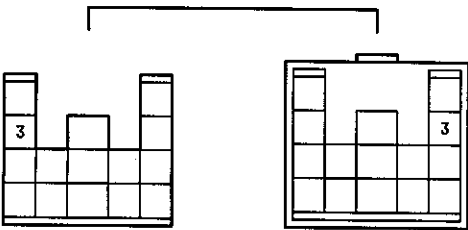

F3 灰色

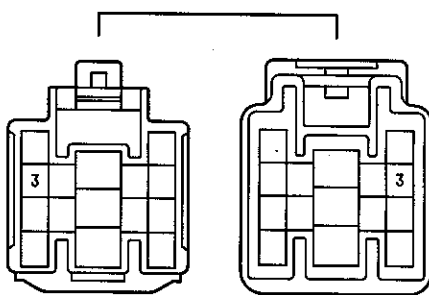

F4

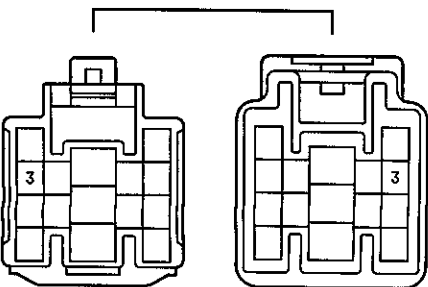

G1 黄色

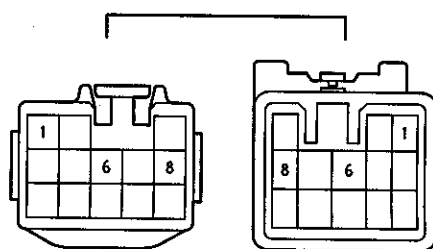

I1 灰色

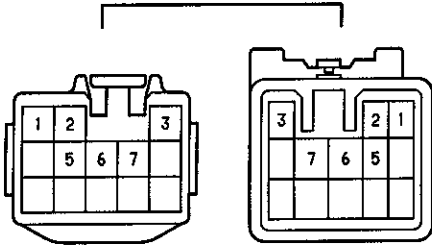

K1 だいだい色

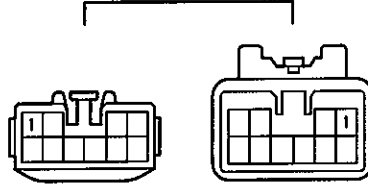

K2 灰色

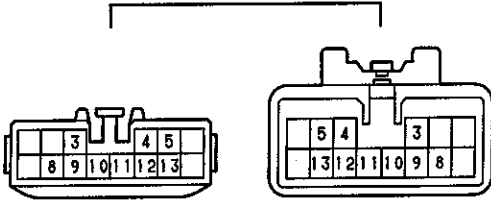

X1 黒色

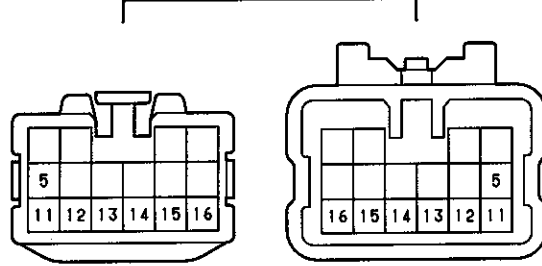

Y1

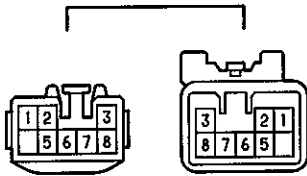



テレホン

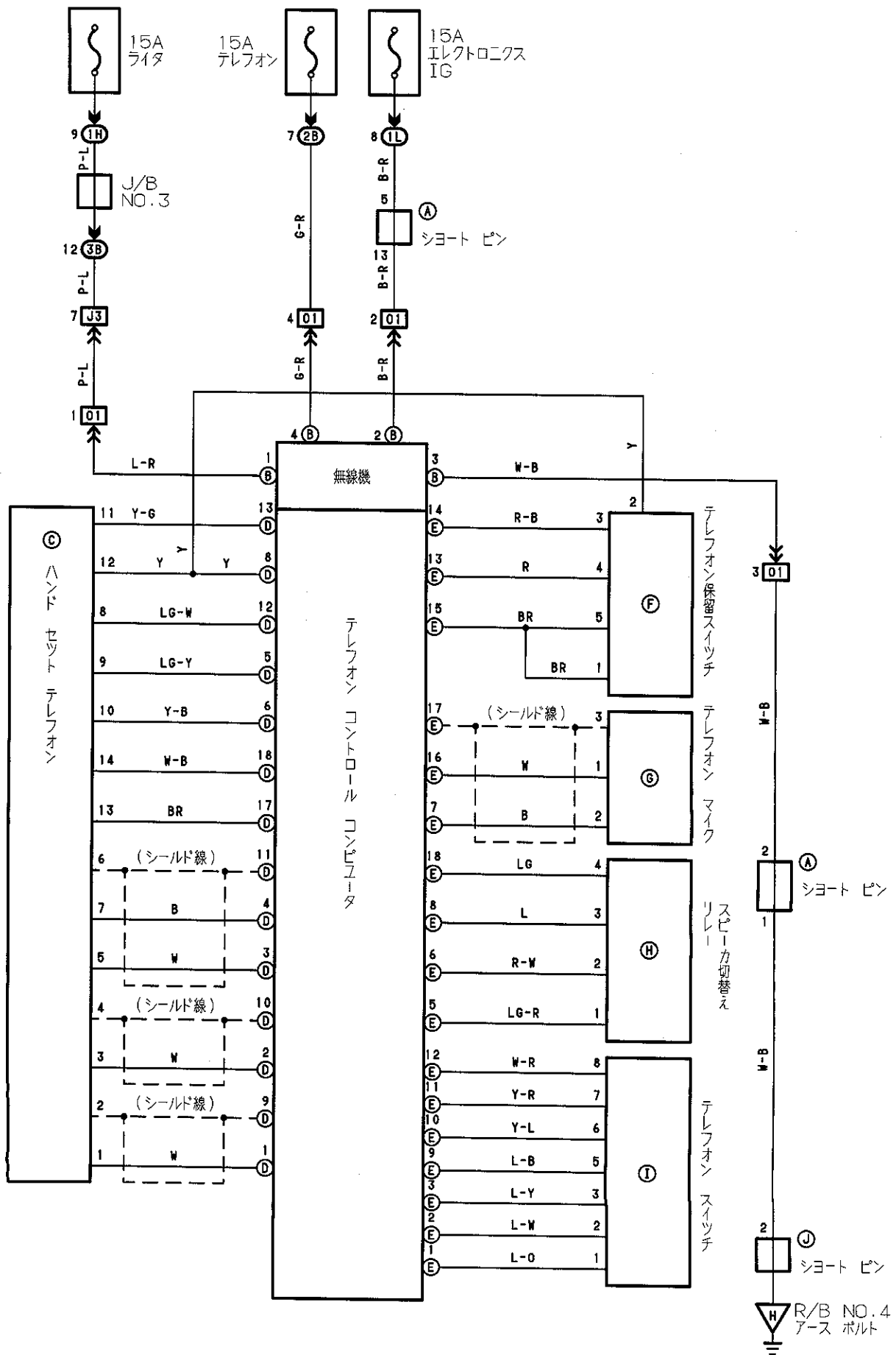

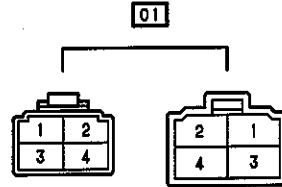
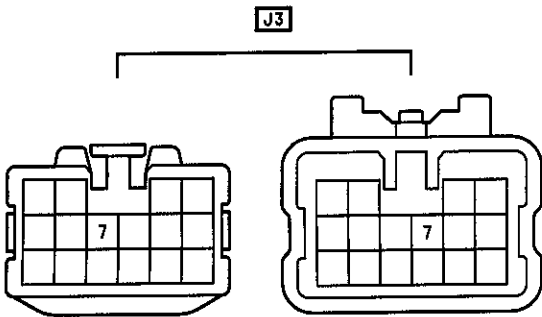
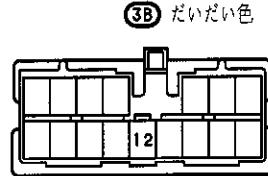
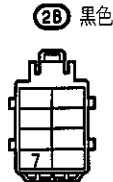
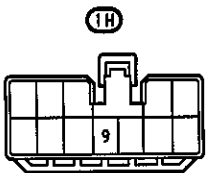
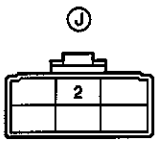
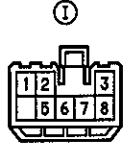
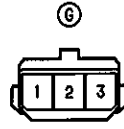
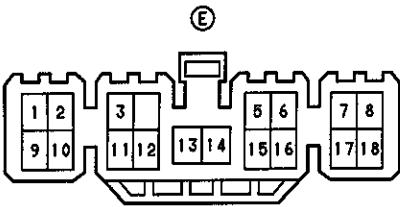
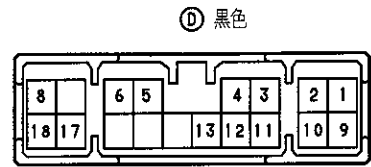
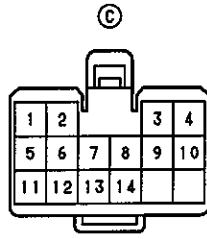
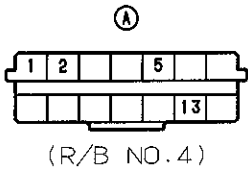

③ ホーン

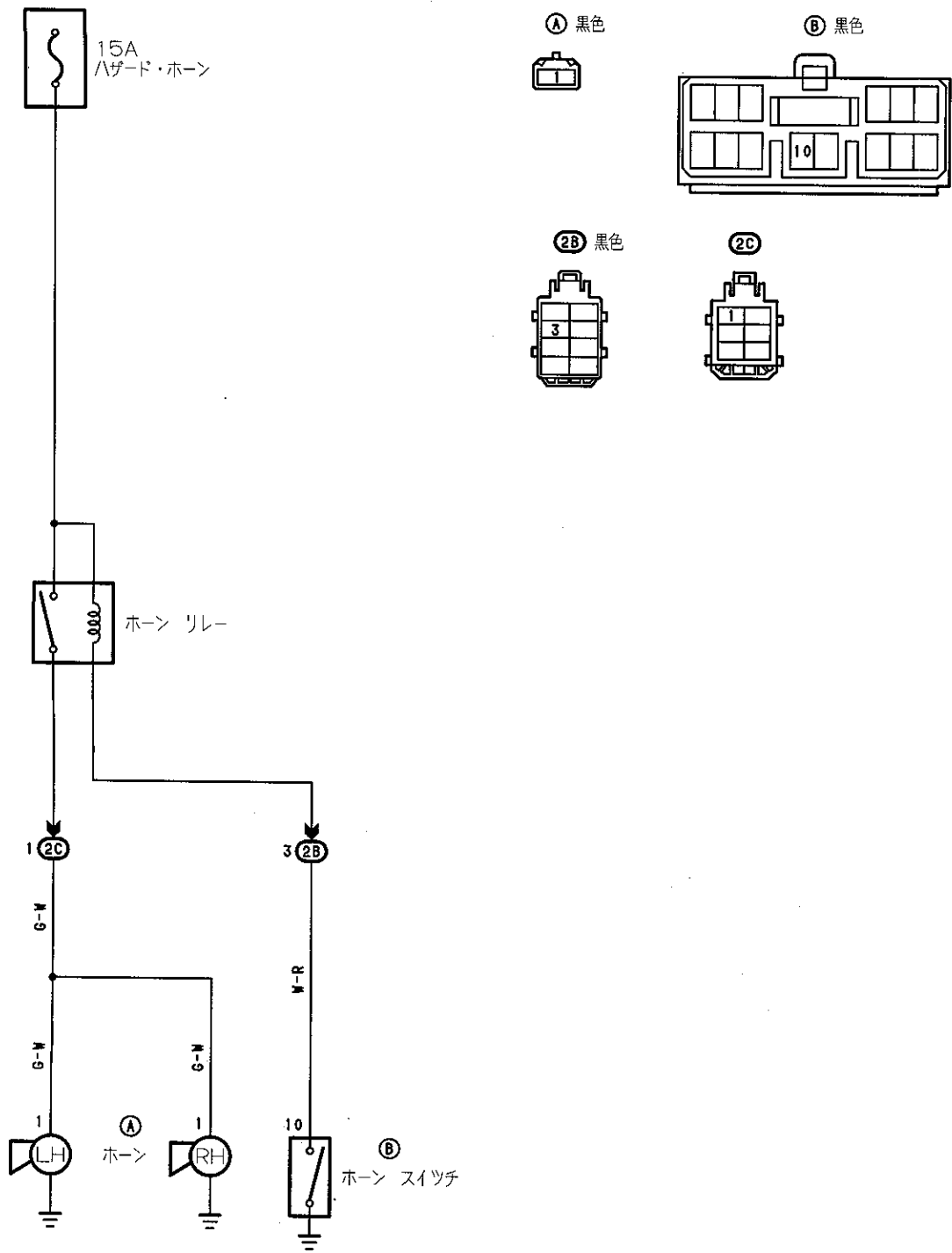

シガレットライター & クロツク

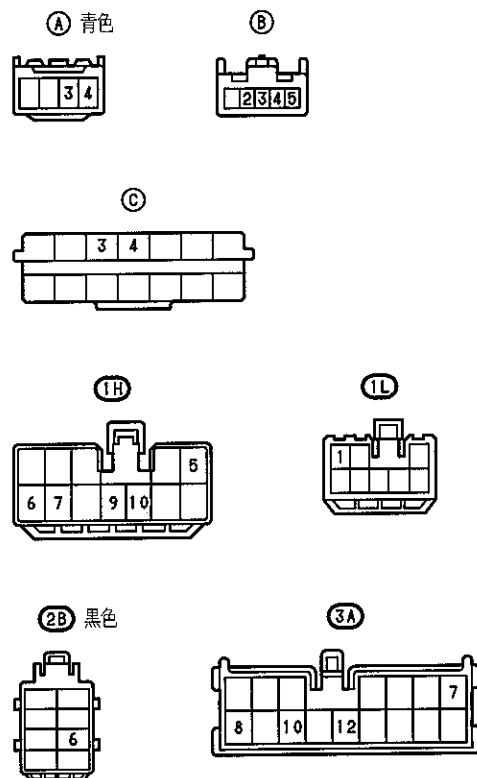
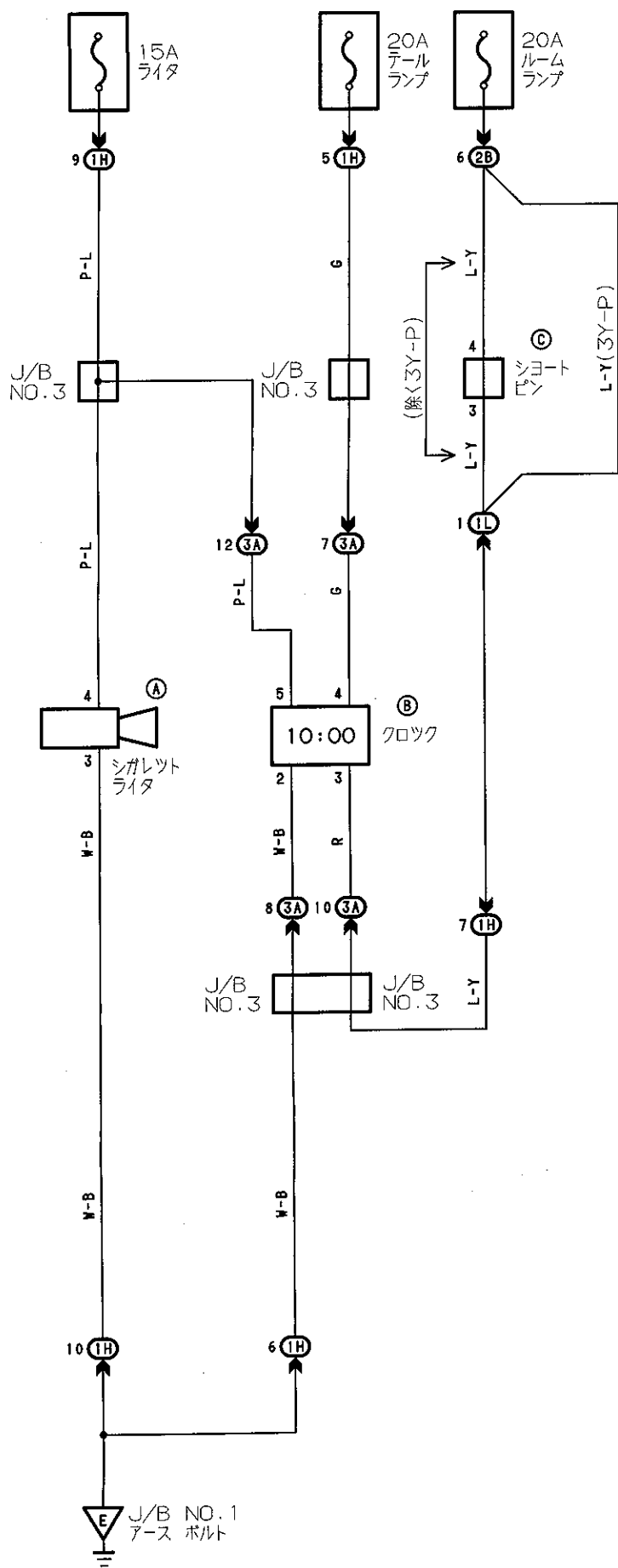



ラジオ & ステレオ(4スピーカ)

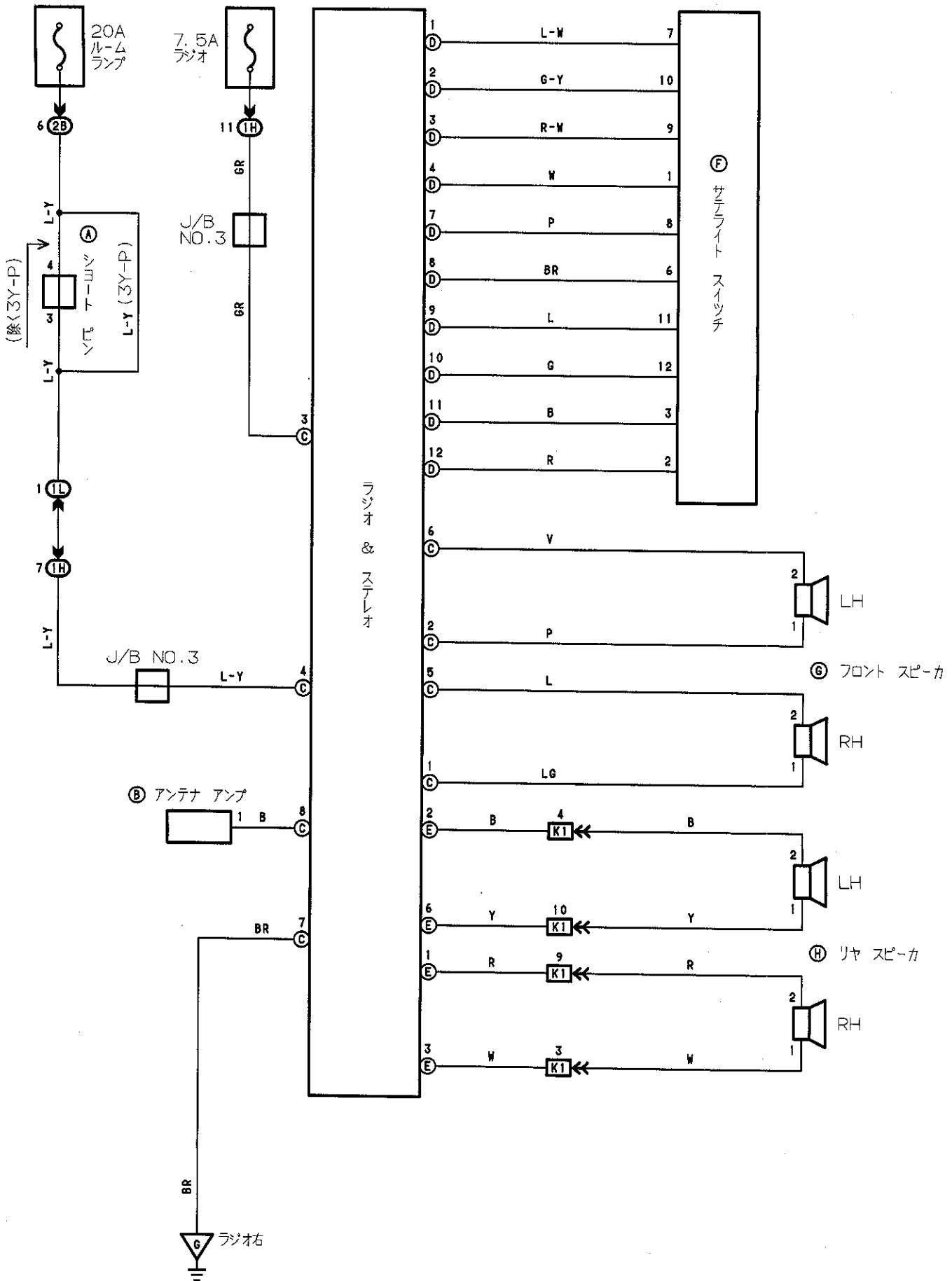

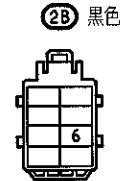
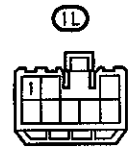
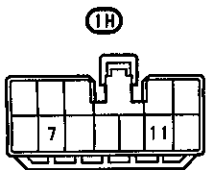
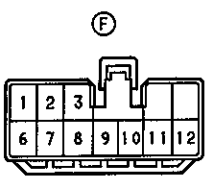
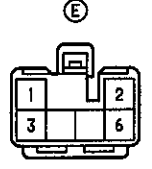
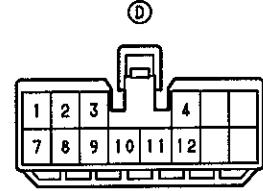
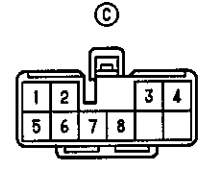
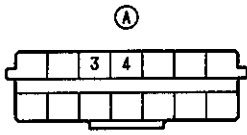

K1 だいたい色

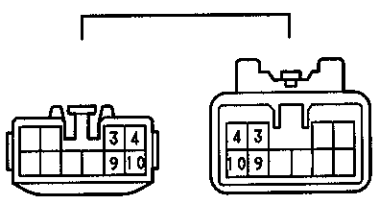

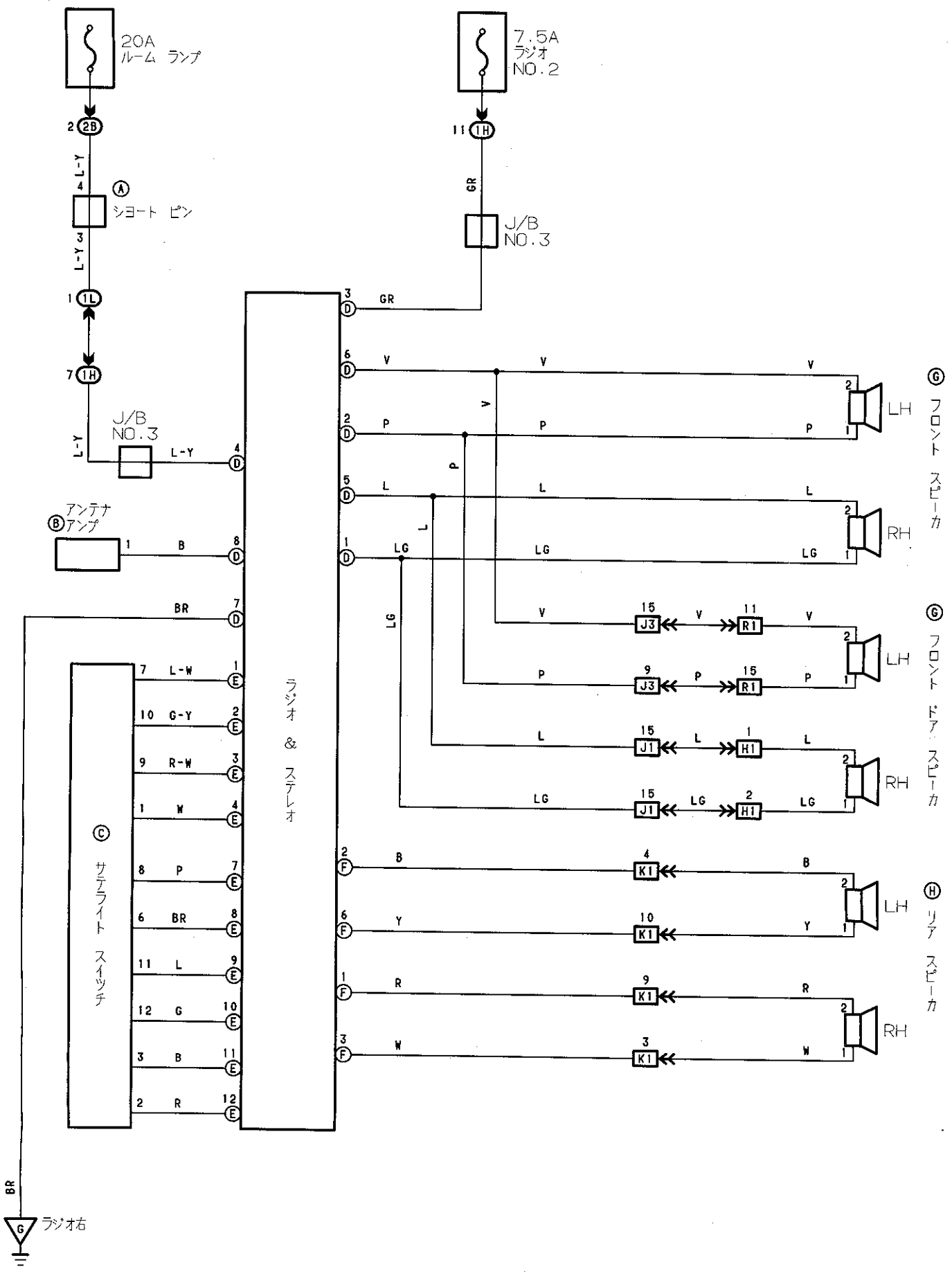

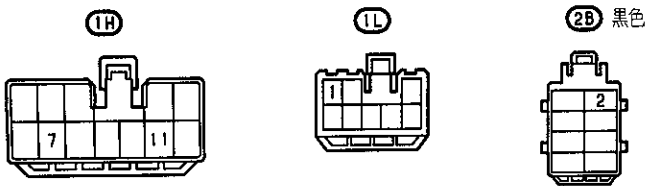
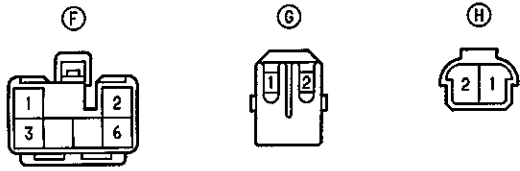
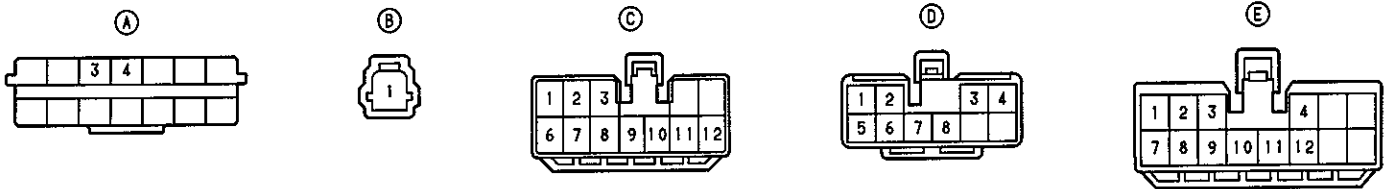

H1 青色

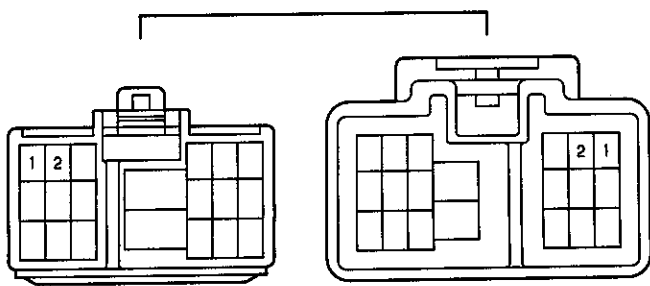

J1 J3

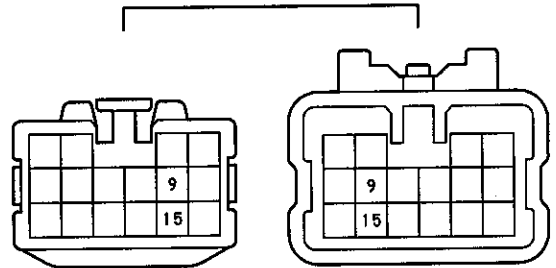

K1 だいたい色

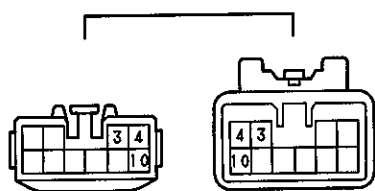

R1 青色

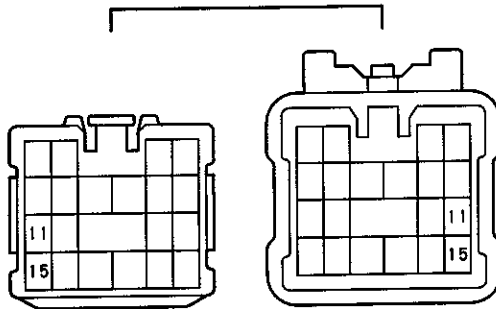

コンビネーション メータ (アナログ)

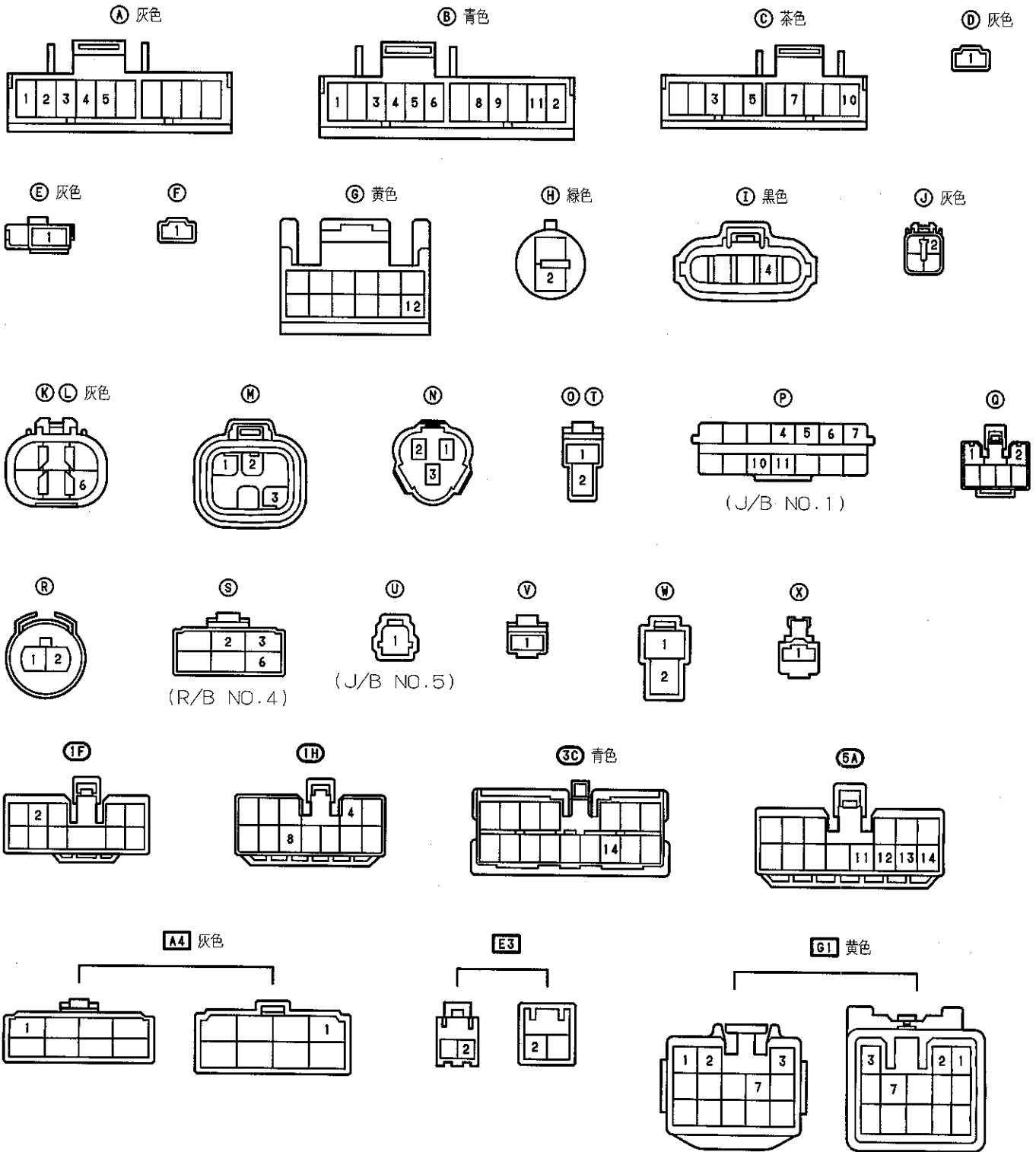

J1 J3

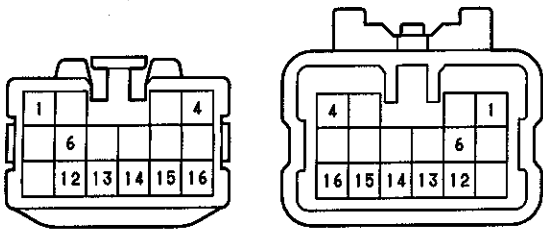

K1 だいだい色

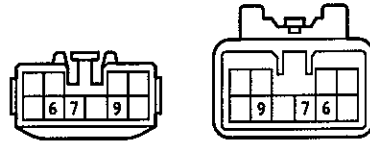

Q1

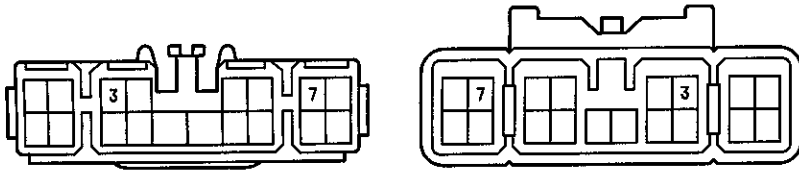

コンビネーション メータ (デジタル)

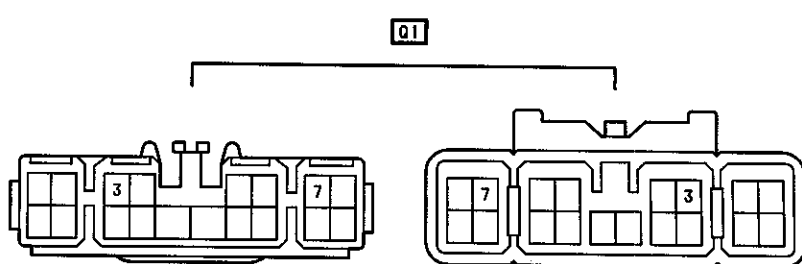
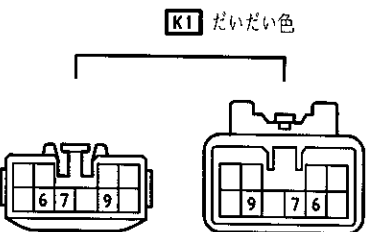
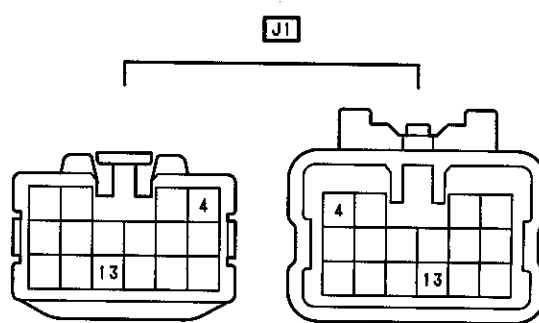
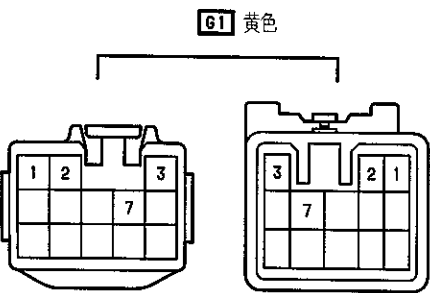
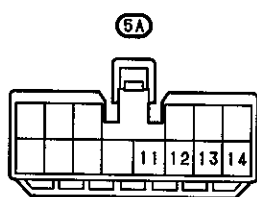
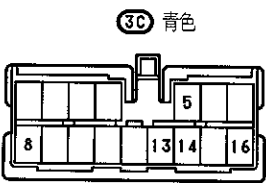
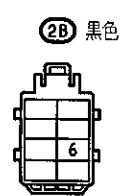
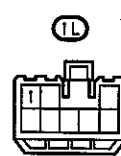
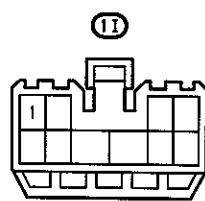
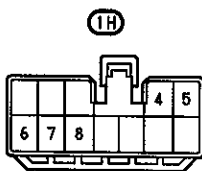
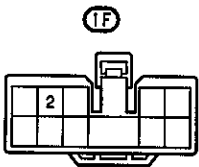
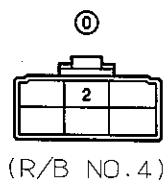
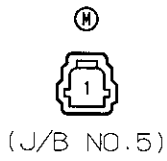
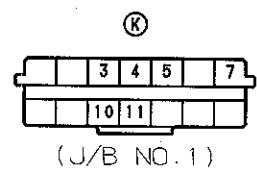
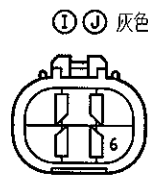
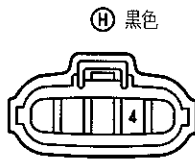
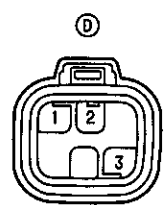
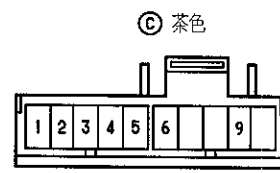
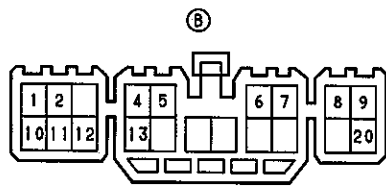
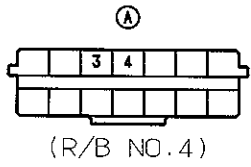

K1 だいたい色

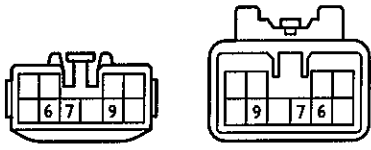

Q1

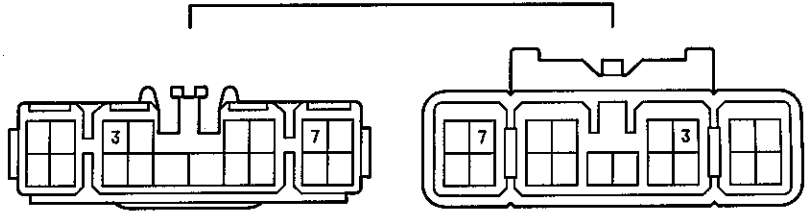

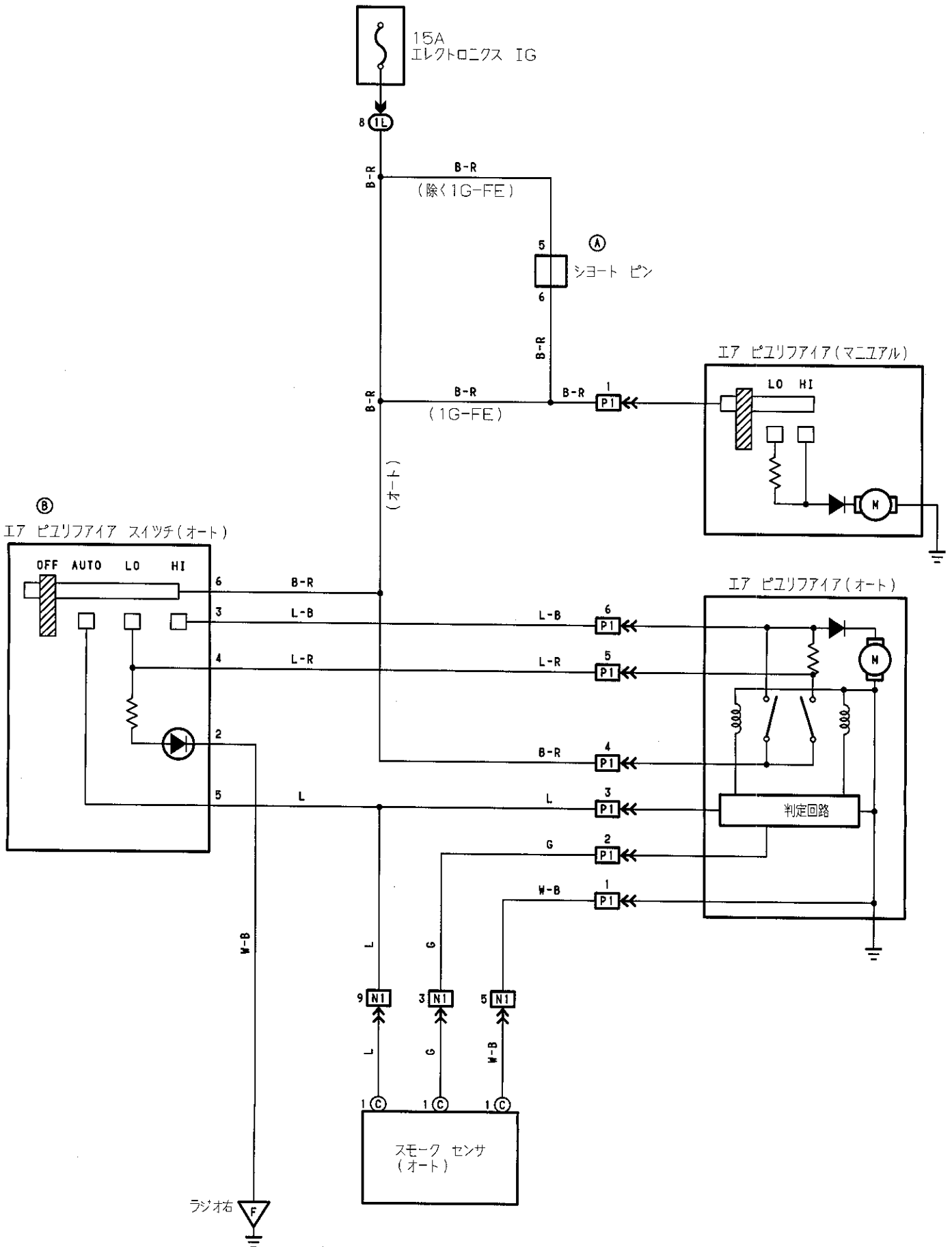

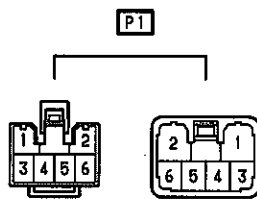
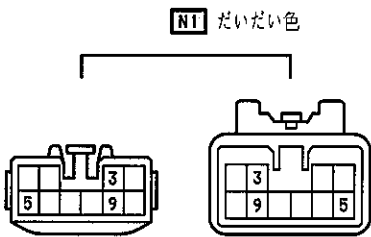
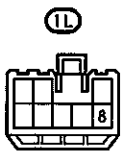
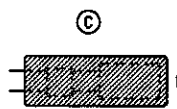
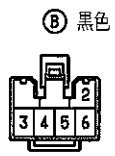
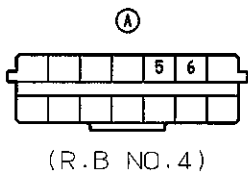

(レバー式 4S-Fi)

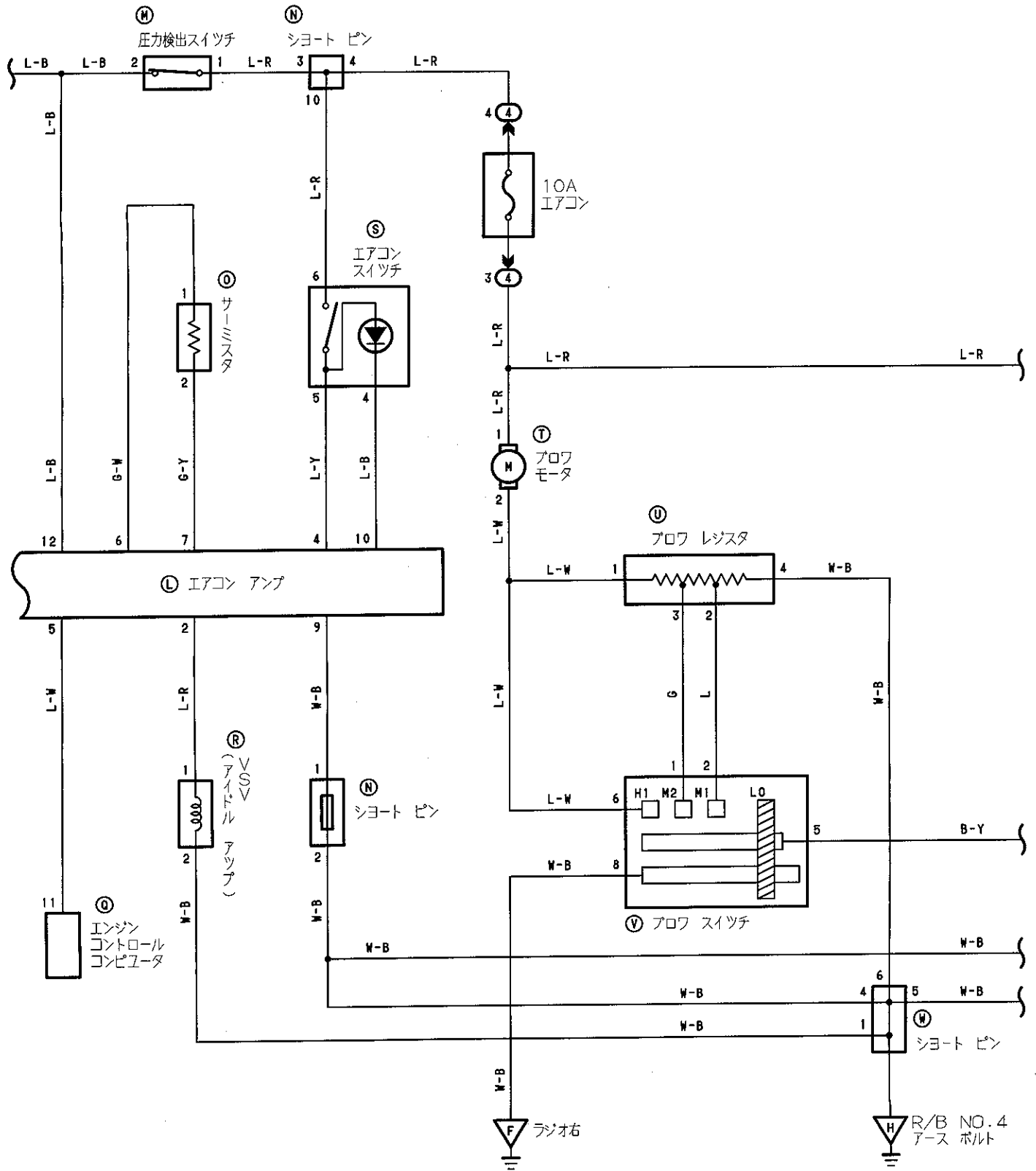



ラジエータ ファン & マニュアル エアコンデিশヨナ

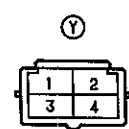
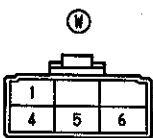
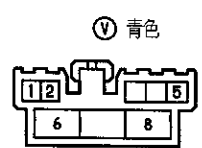
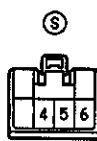
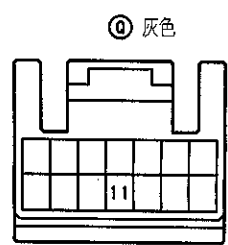
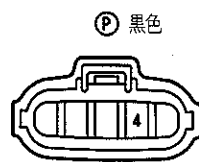
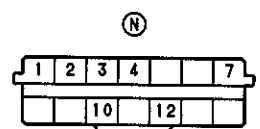
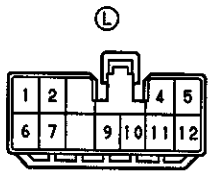
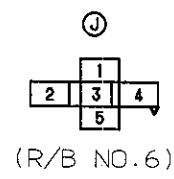
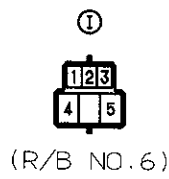
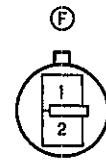
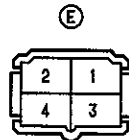
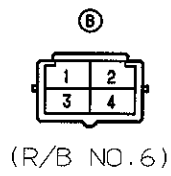
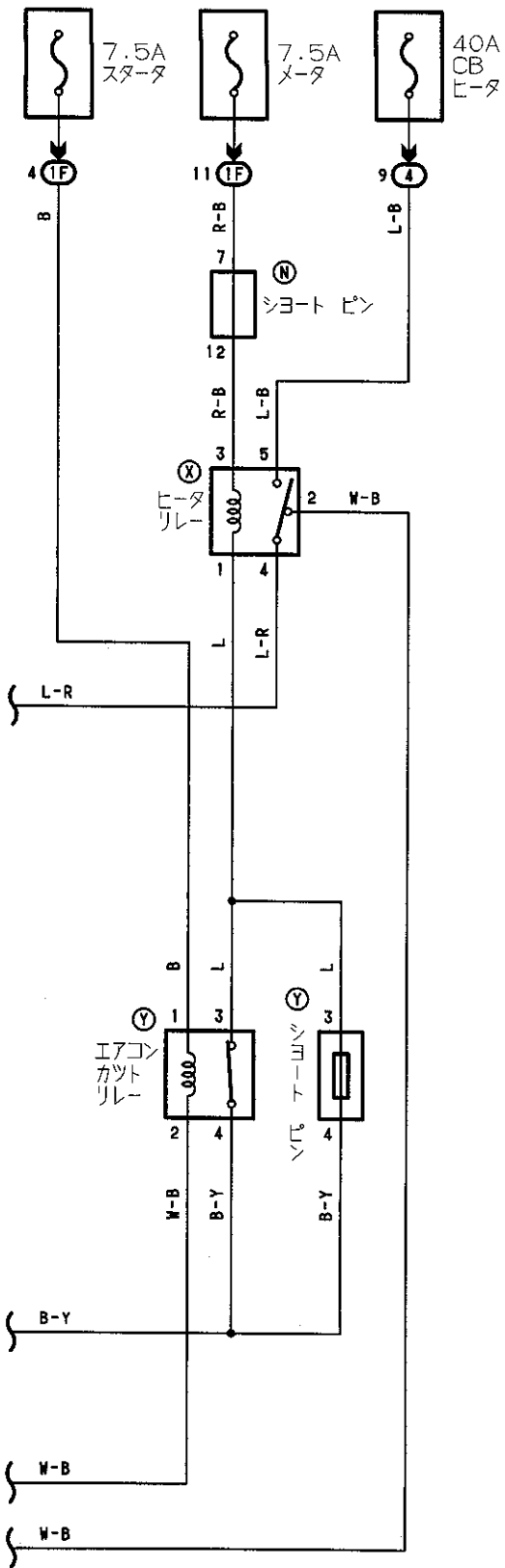

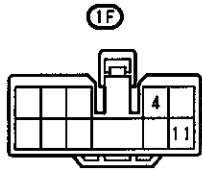
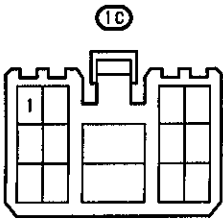

A2 灰色

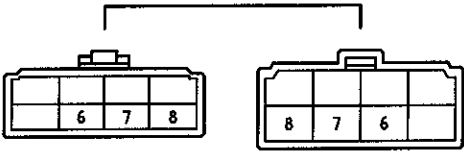

F1 黄色

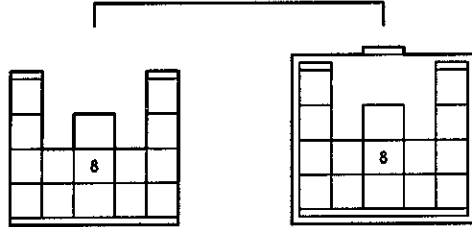

G1 黄色

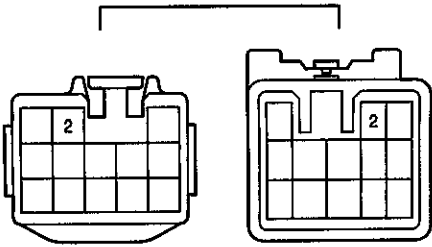

J1

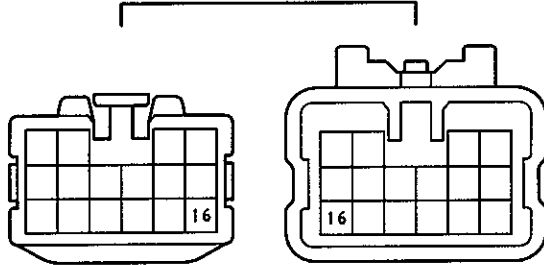



マニュアル エアコンディショナ(レバー式 2L, 2L-T)

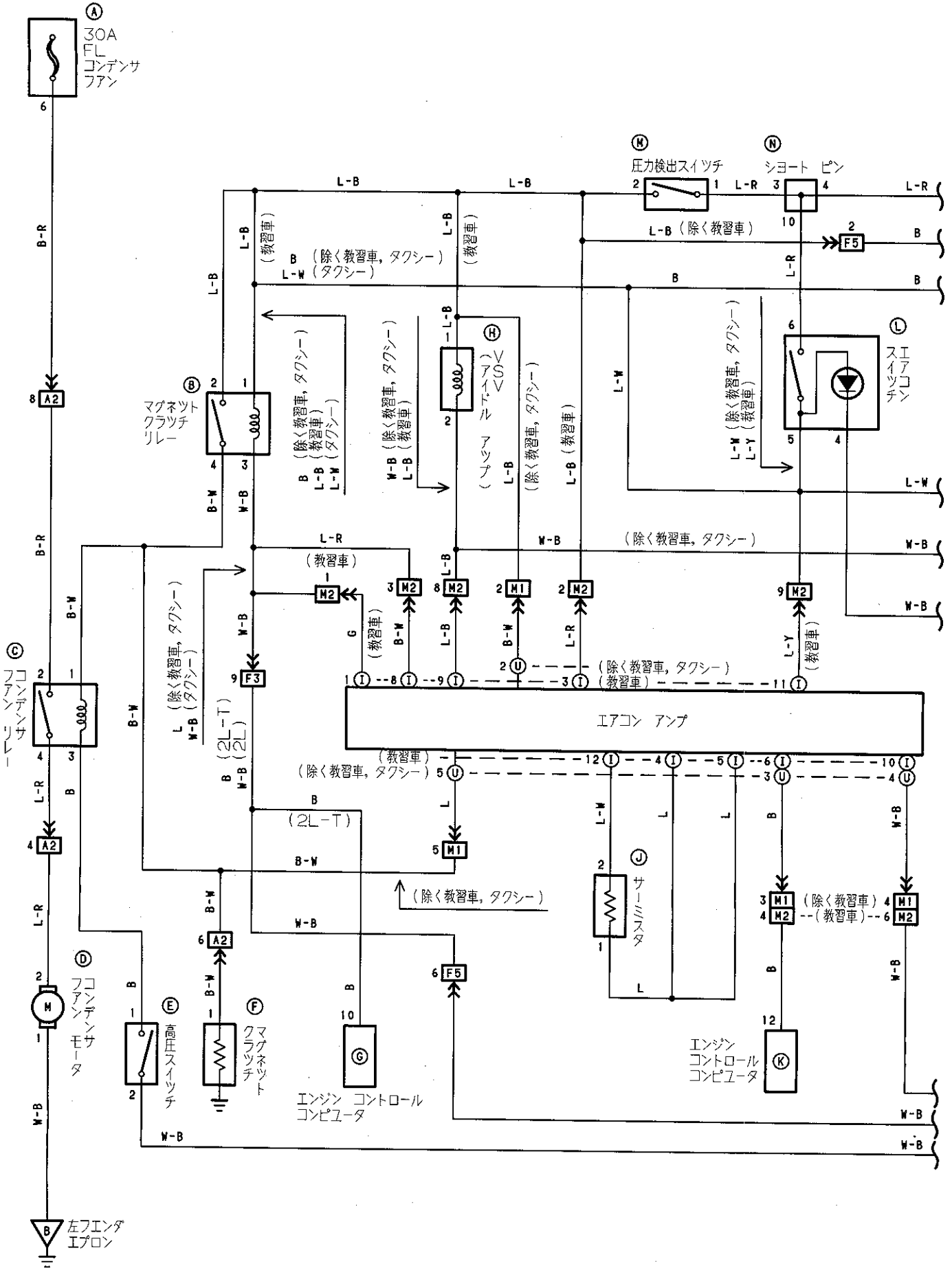

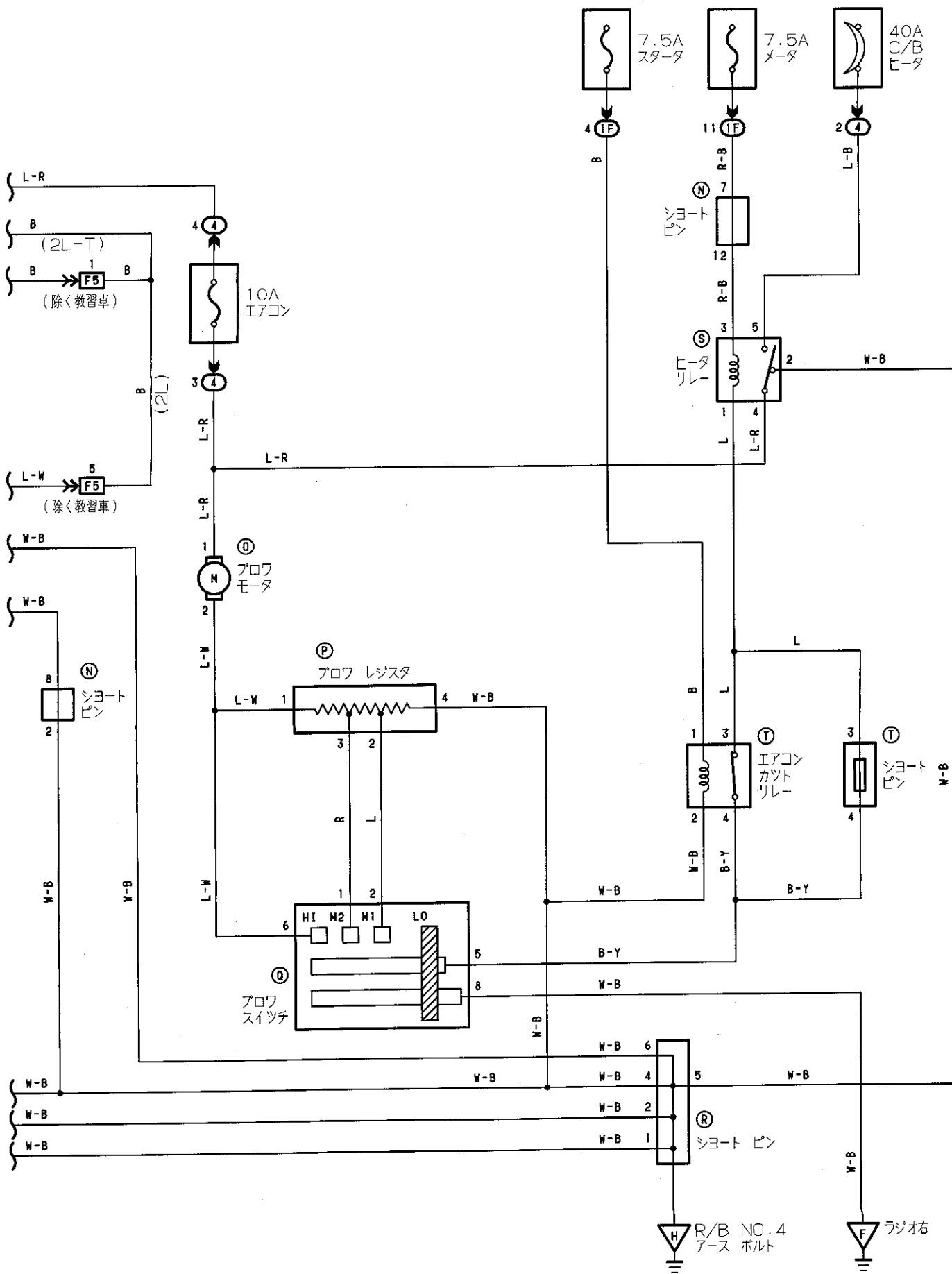



マニュアル エアコンディショナ(レバー式 2L, 2L-T)

Ⓐ 黒色

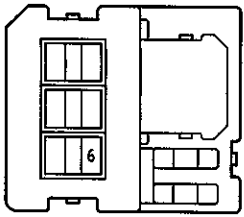

Ⓑ



Ⓒ 灰色

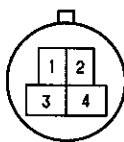

Ⓓ 黒色



Ⓔ 黒色



Ⓕ



Ⓖ 灰色

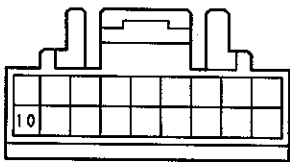

Ⓕ Ⓖ



Ⓖ

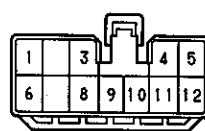

Ⓖ



Ⓚ 灰色

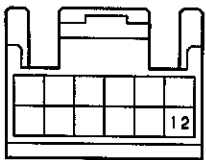

Ⓛ 青色



Ⓜ 茶色



Ⓝ

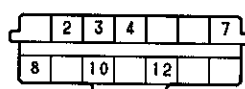

Ⓟ

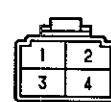

Ⓢ 青色

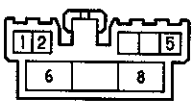

Ⓡ

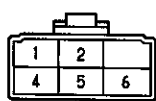

Ⓢ



Ⓣ

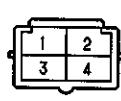

Ⓤ

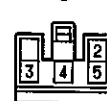

(R/B NO.4)

(R/B NO.4)

Ⓣ

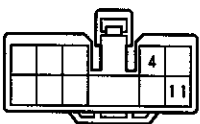

ⓐ2 灰色

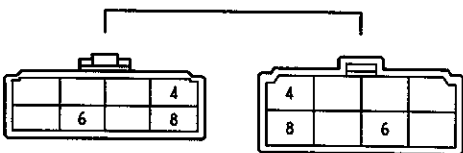

ⓐ3 灰色

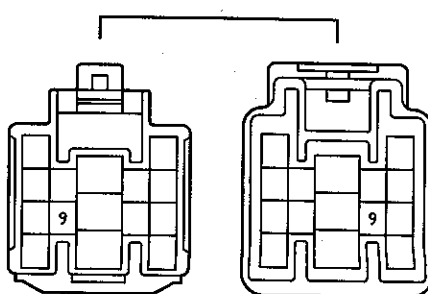

F5 灰色

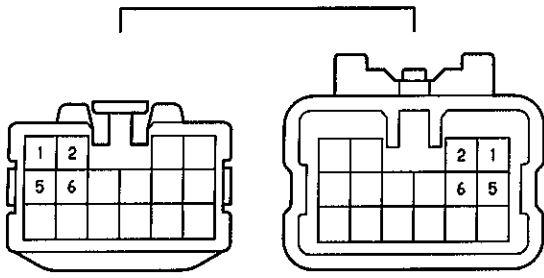

M1

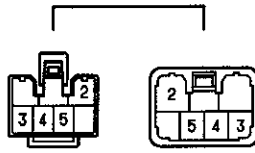

M2

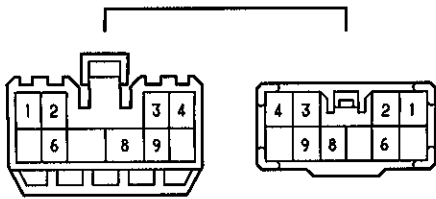



マニュアル エアコンデিশヨナ(3Y-P)

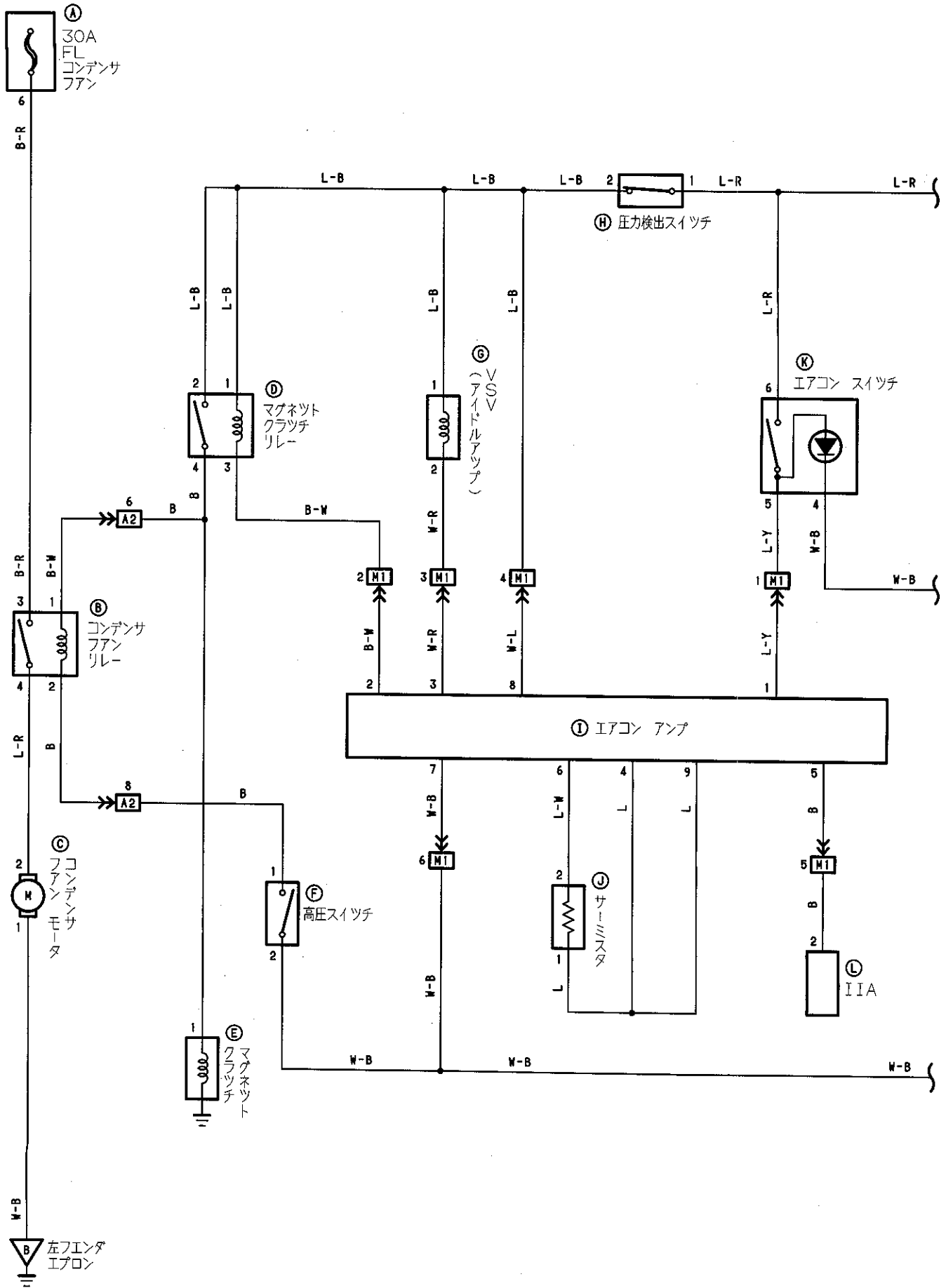

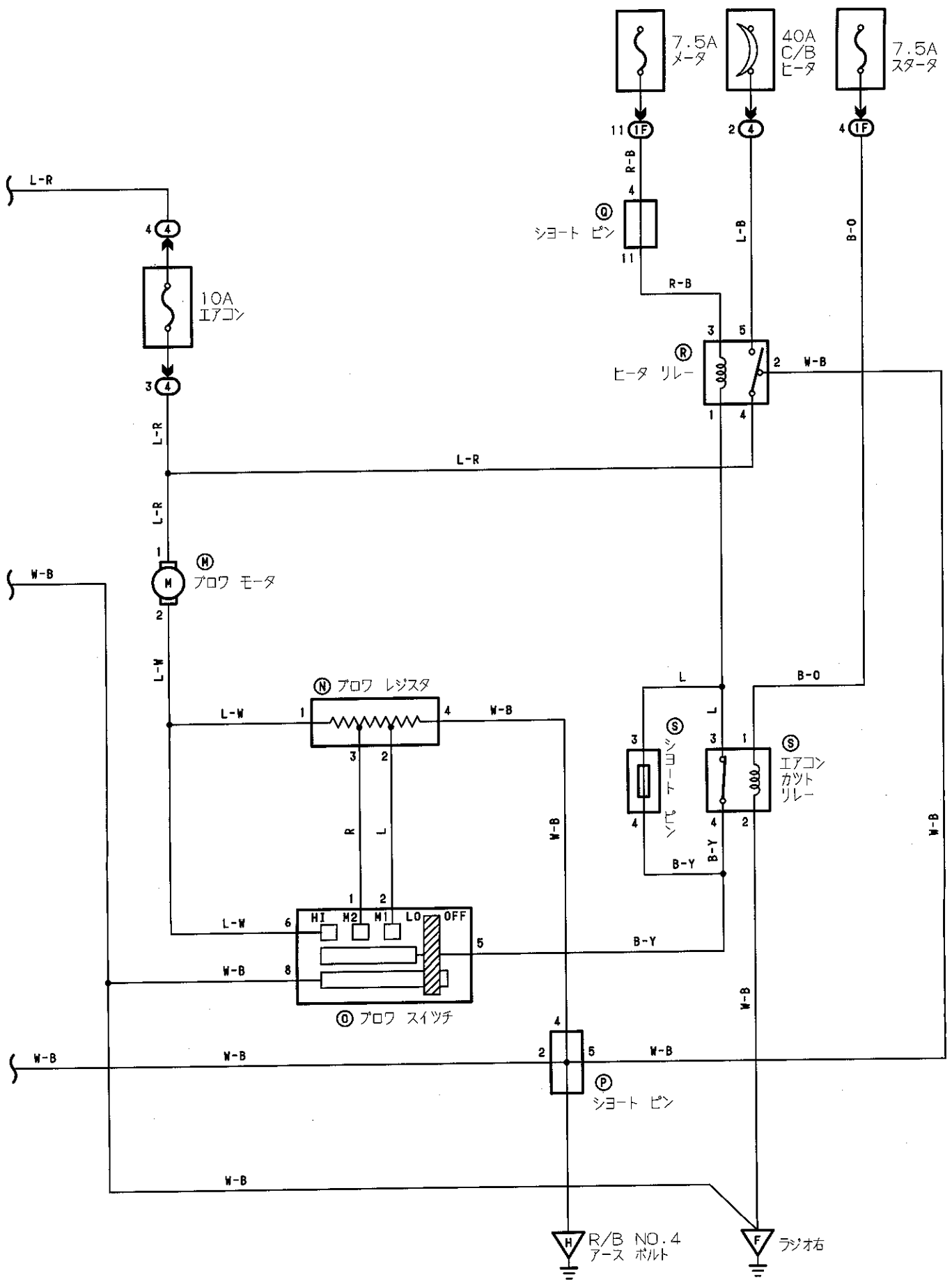



マニュアル エアコンデিশヨナ(3Y-P)

Ⓐ 黒色

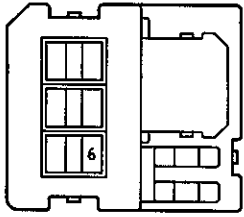

Ⓑ 灰色



Ⓒ 黒色



Ⓓ

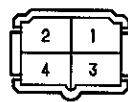

Ⓔ



Ⓕ 黒色



Ⓖ Ⓜ



ⓓ 茶色



ⓓ

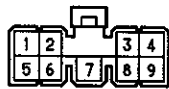

ⓓ



ⓓ 青色

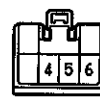

ⓓ 緑色



ⓓ



ⓓ 青色

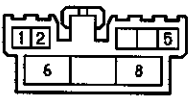

ⓓ

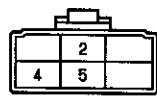

(R/B NO.4)

ⓓ



ⓓ



(R/B NO.4)

ⓓ

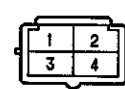

ⓓ

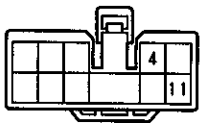

ⓓ2 灰色

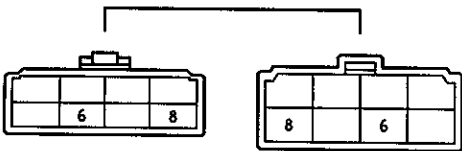

ⓓ1

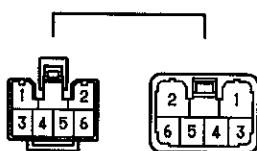



ラジエータ ファン & エアコンディショナ

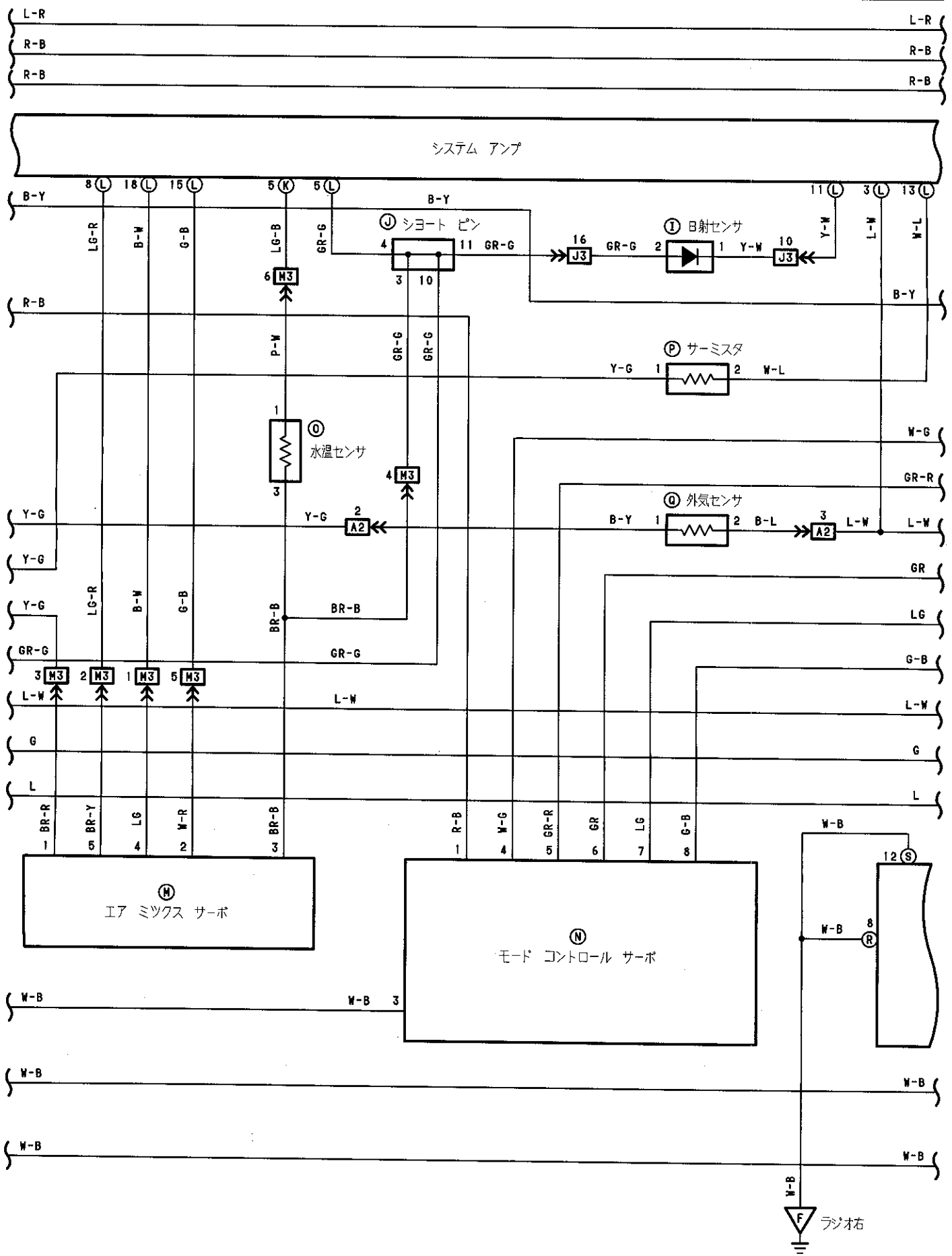

(4S-F, Eグレード)

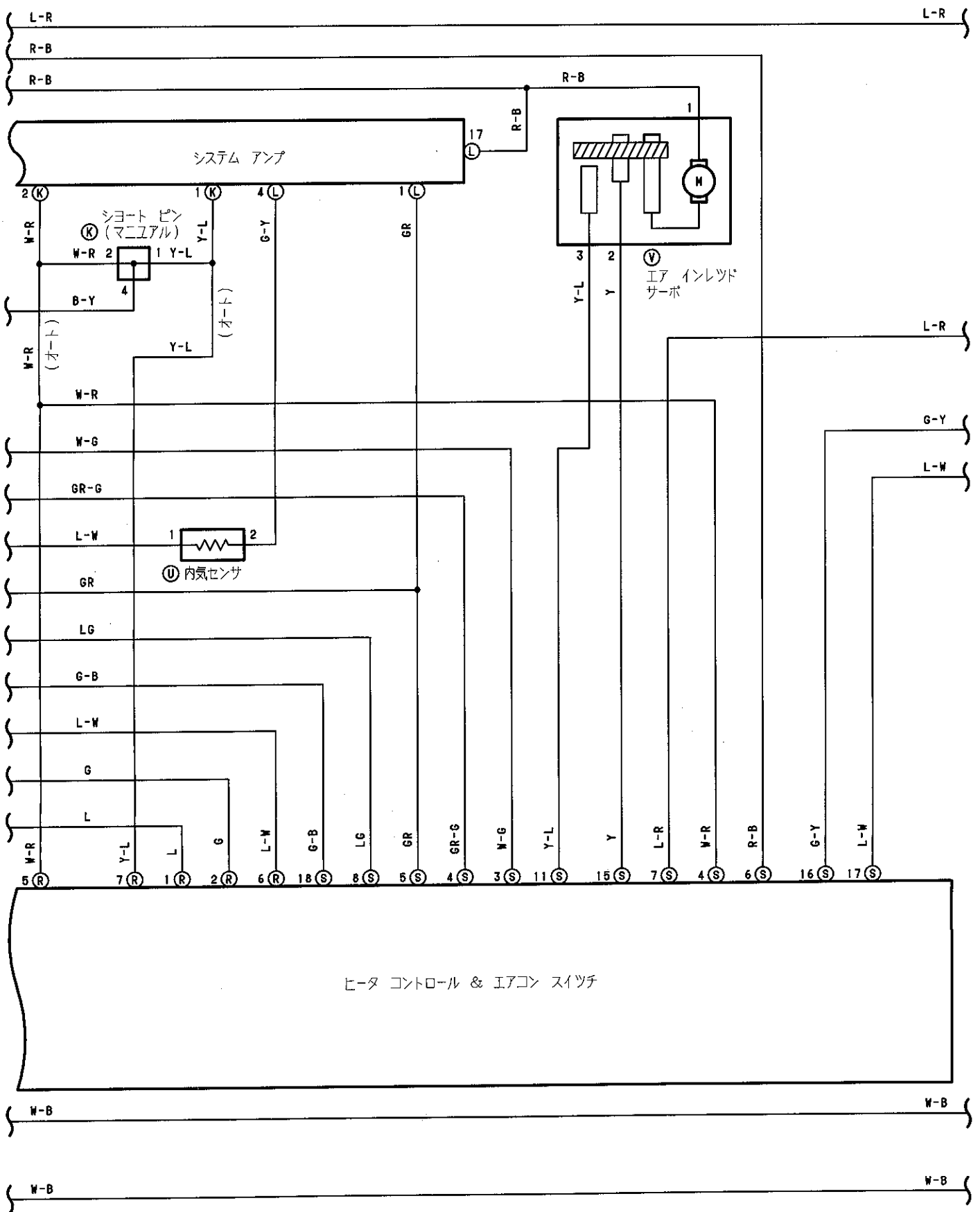

ラジエータ ファン & エアコンデিশヨナ

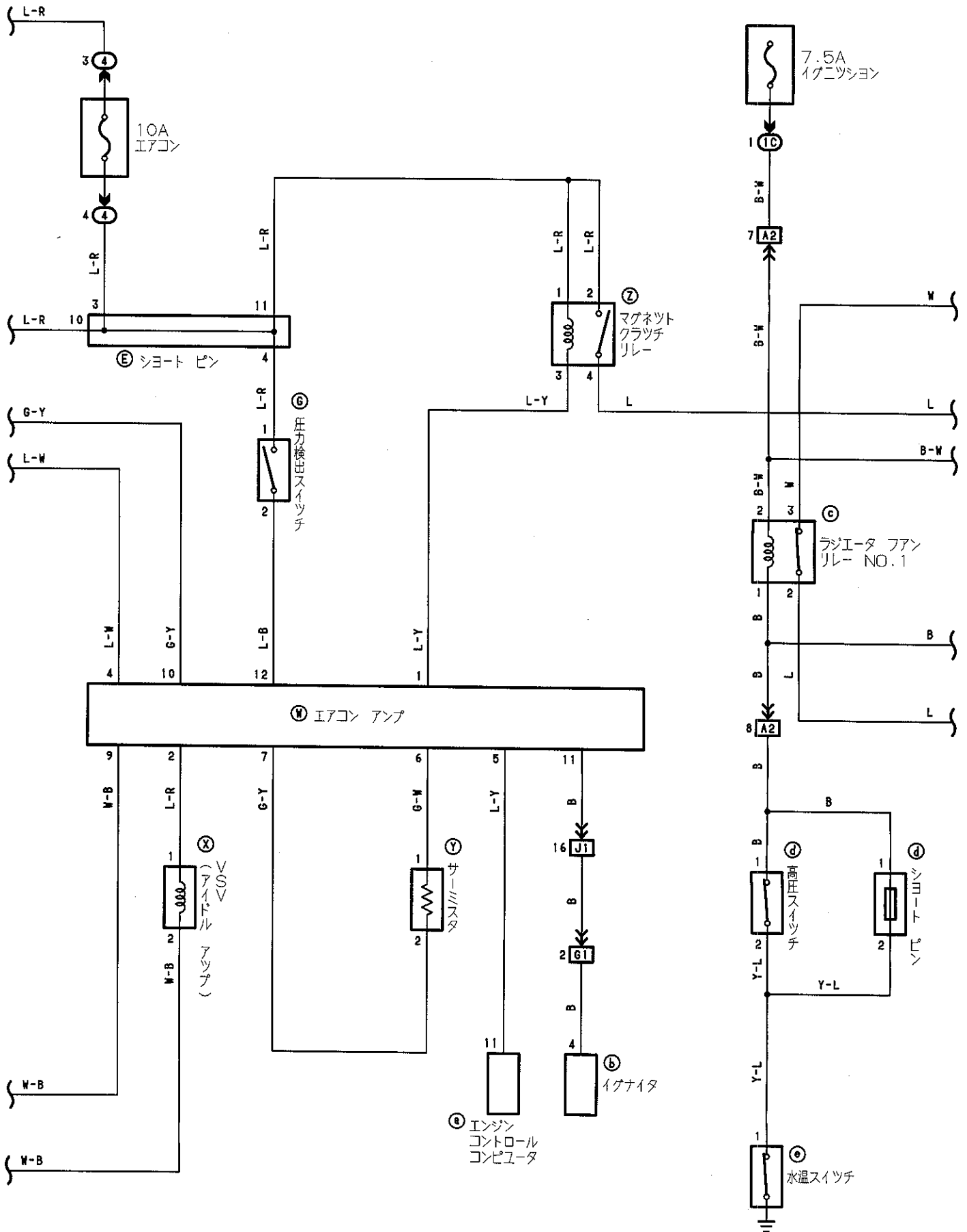

(4S-FI Eグレード)

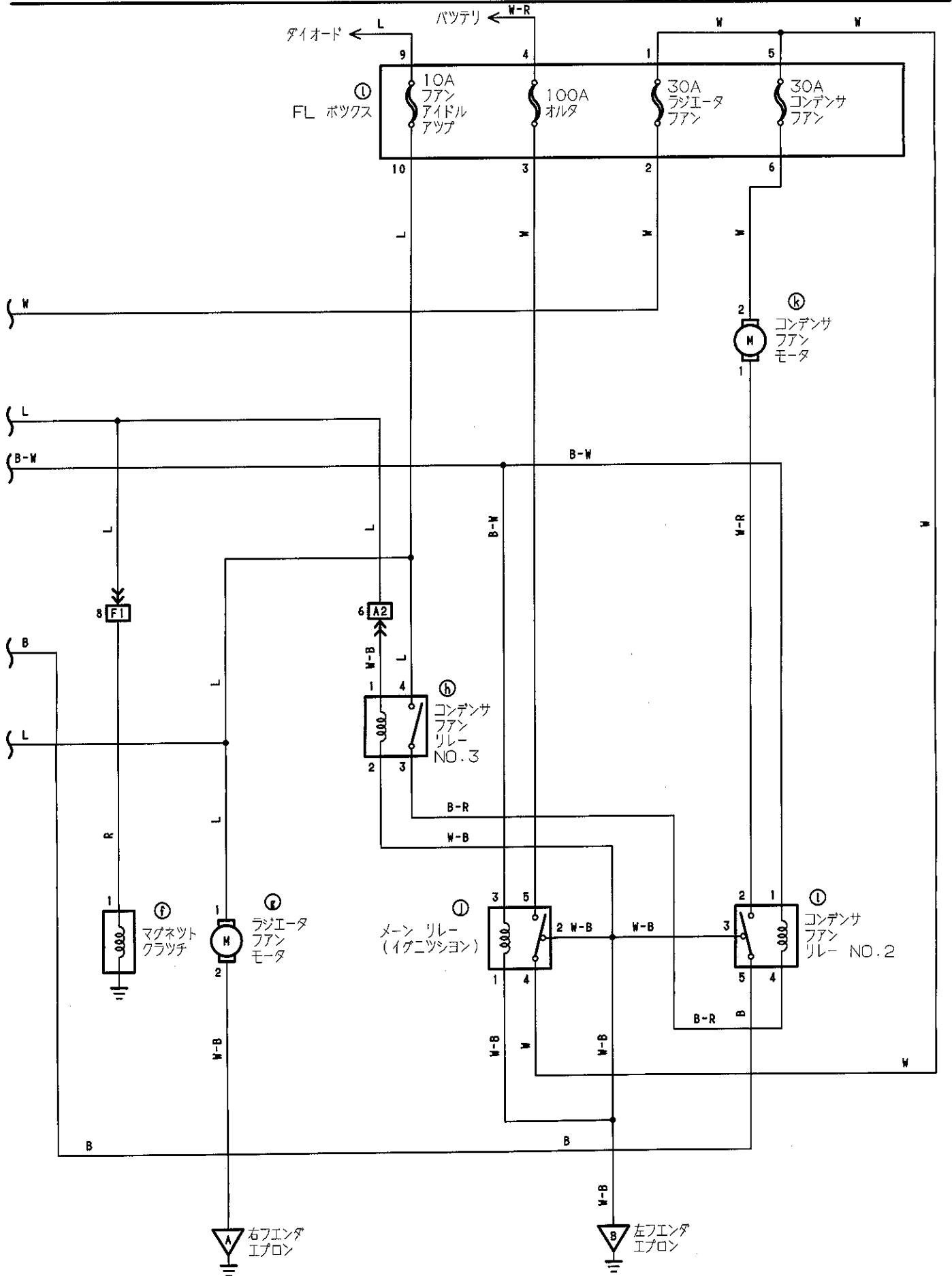



ラジエータ ファン & エアコンデショナ

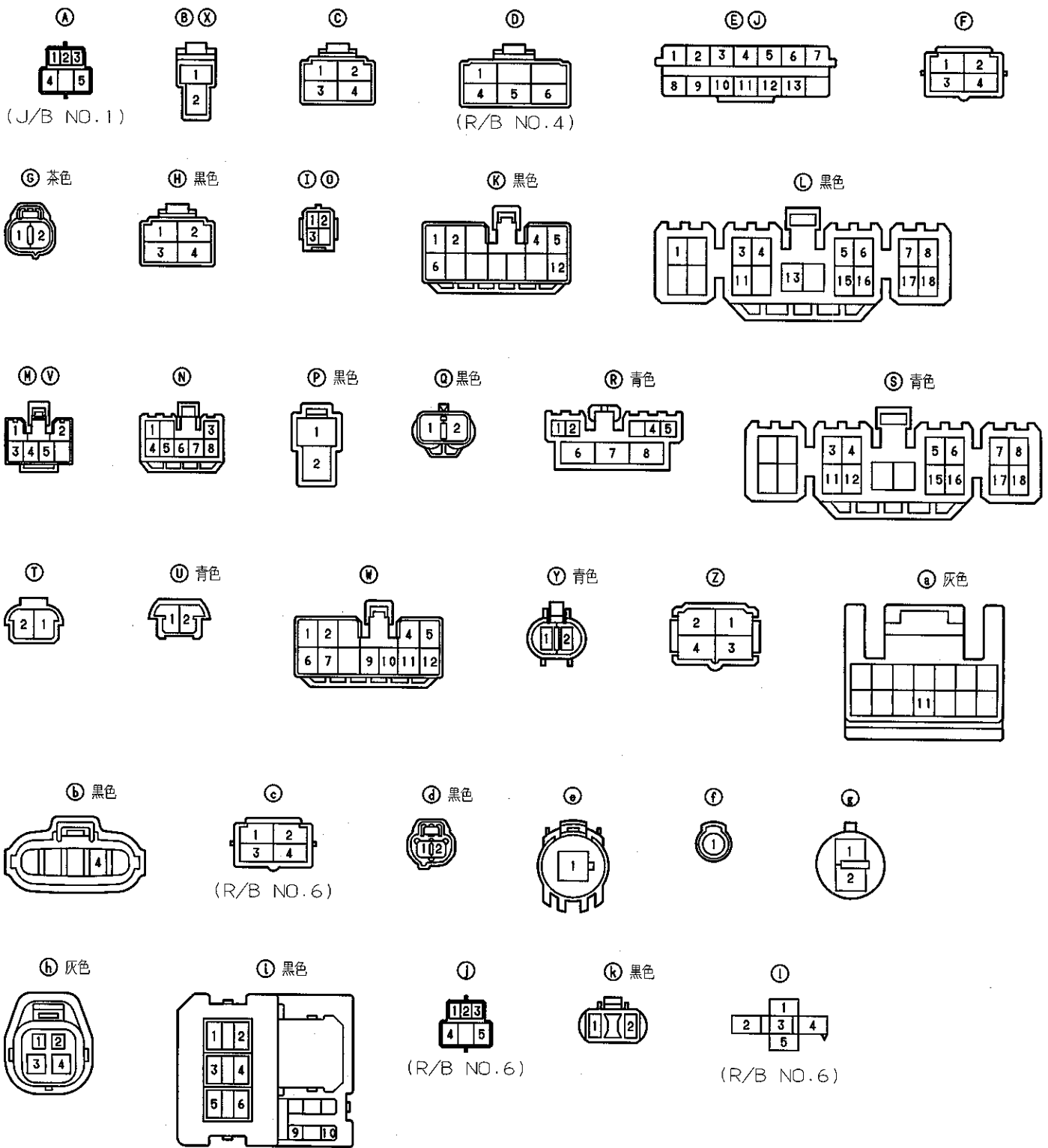

(4S-F Eグレード)

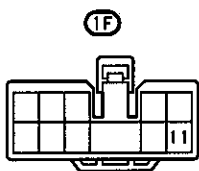
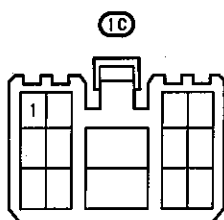

A2 灰色

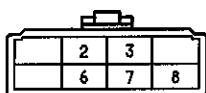

G1 黄色

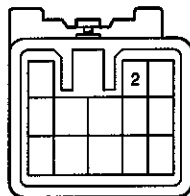
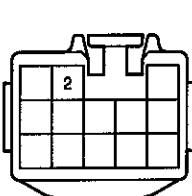

J1 J3

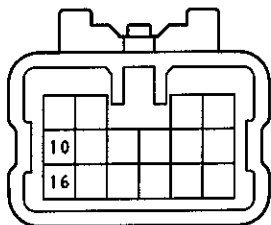
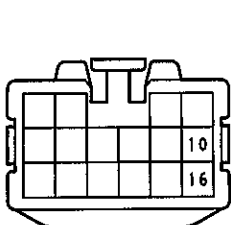

M3

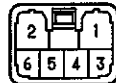



エアコンディショナ(Gグレード)

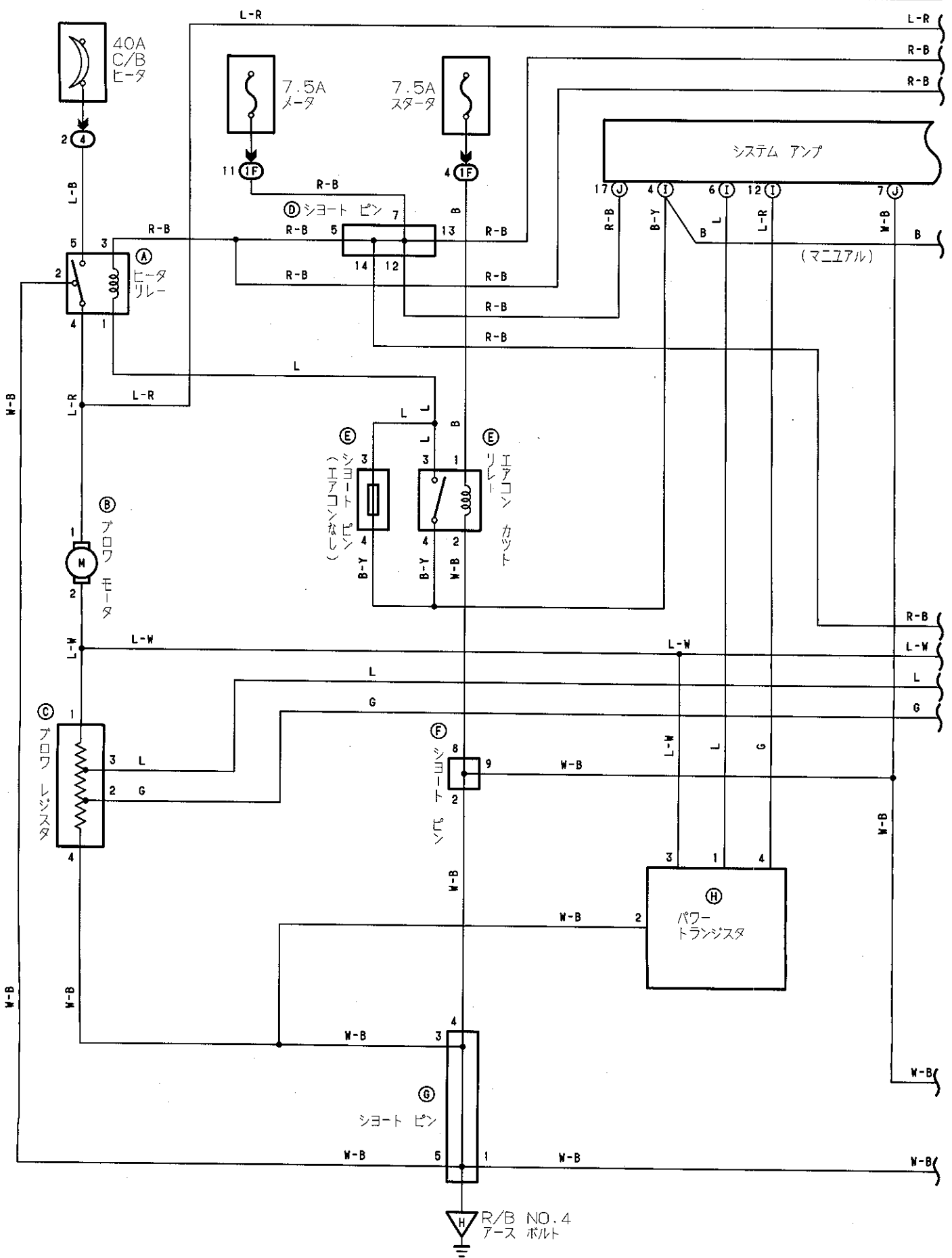



エアコンディショナ(Gグレード)

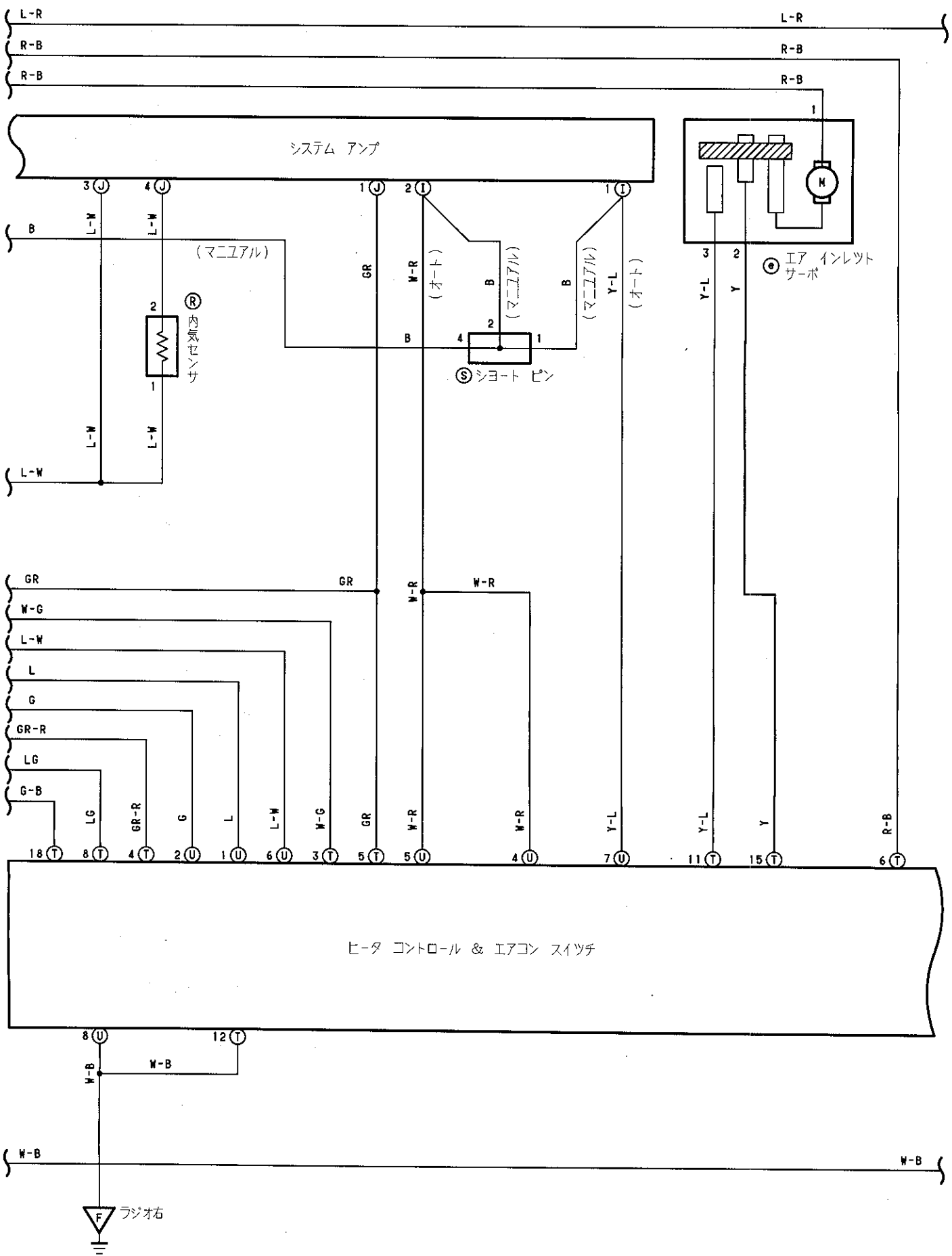



エアコンディショナ (Gグレード)

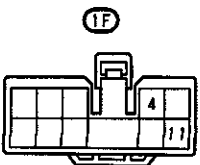
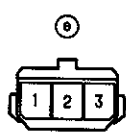
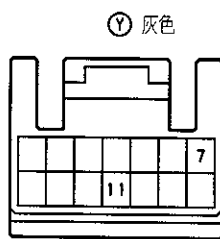
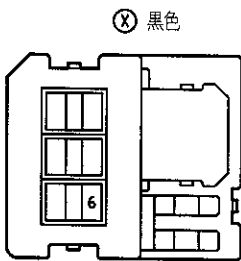
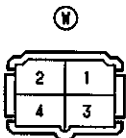
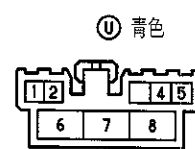
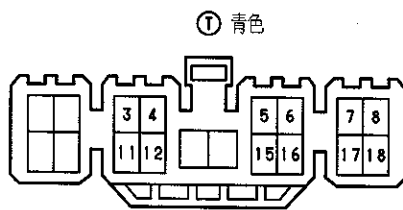
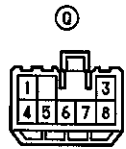
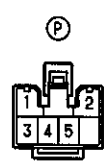
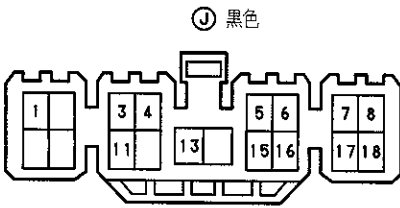
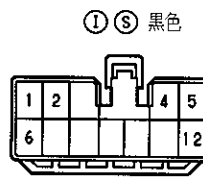
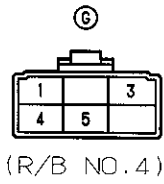
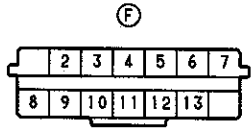
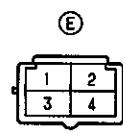
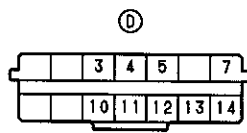
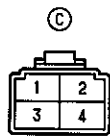
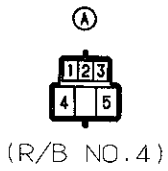

A2 灰色

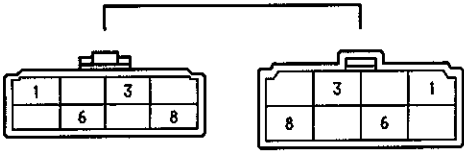

F1 黄色

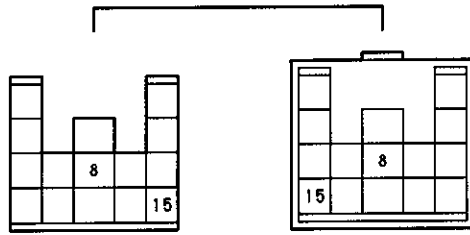

J3

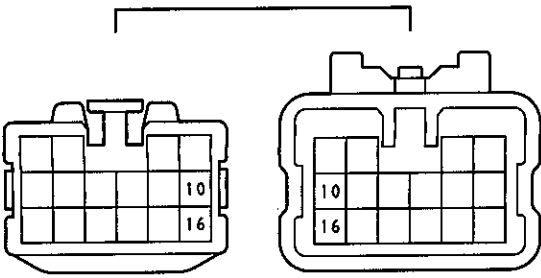

H3

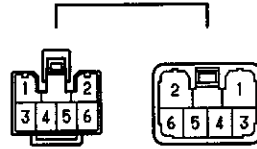

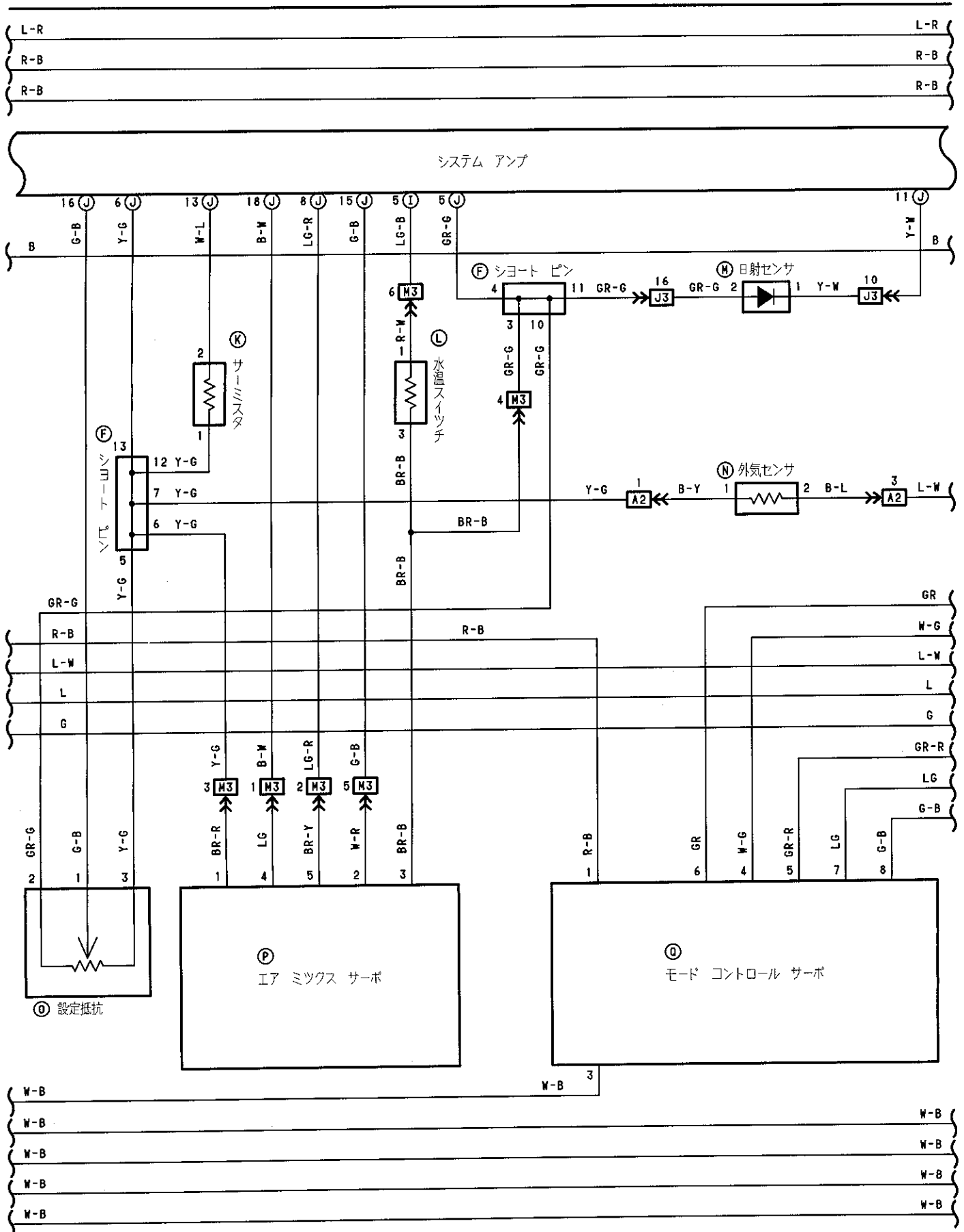



オート エアコンデিশヨナ(2L-T)

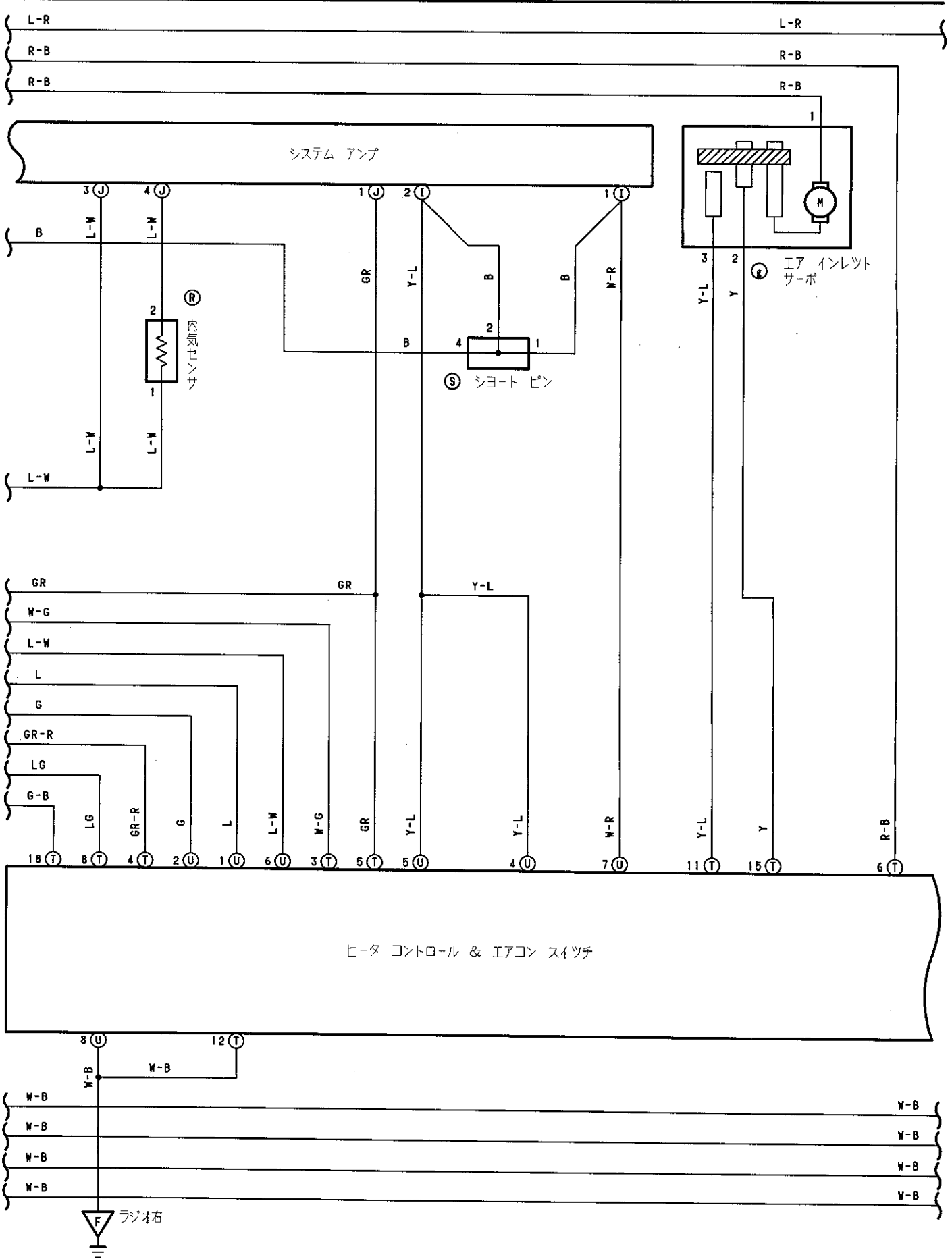

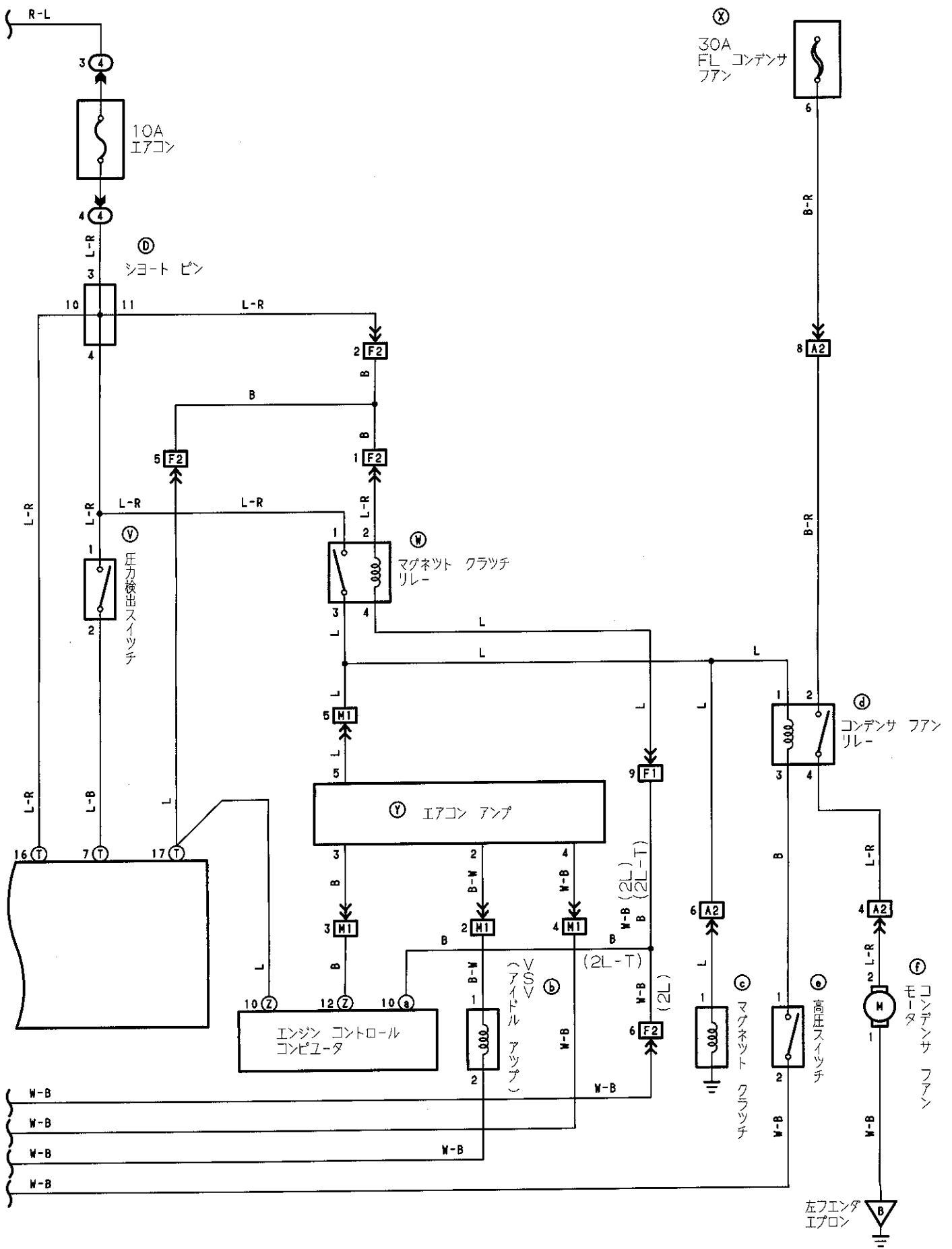



オート エアコンディショナ(2L-T)

Ⓐ



Ⓑ Ⓑ



Ⓒ

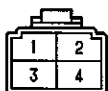

Ⓓ

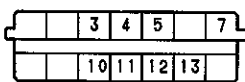

Ⓔ

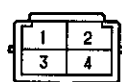

(R/B NO. 4)

Ⓕ

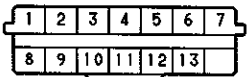

Ⓖ



(R/B NO. 4)

Ⓗ 黒色



Ⓘ Ⓢ 黒色

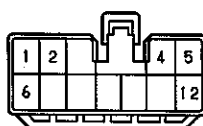

Ⓙ 黒色

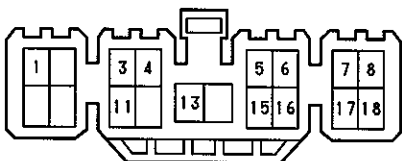

Ⓚ



Ⓛ Ⓣ



Ⓜ 黒色



Ⓝ 黒色



Ⓟ



Ⓛ



Ⓡ 青色



Ⓣ 青色

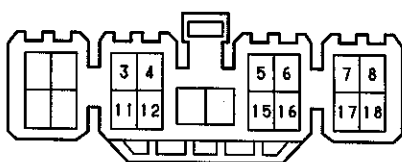

Ⓤ 青色

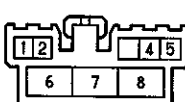

Ⓥ 茶色



Ⓜ

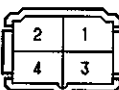

Ⓧ 黒色

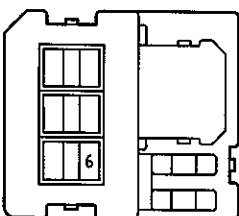

Ⓨ

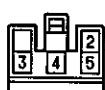

Ⓩ 灰色

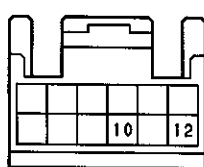

ⓐ 灰色

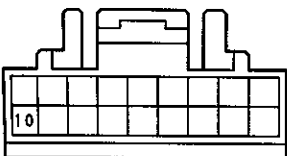

ⓑ



Ⓒ 灰色

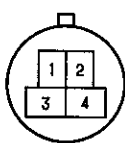

Ⓓ 黒色



Ⓔ 黒色



Ⓛ



ⓁⒻ

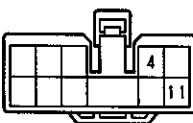

A2 灰色

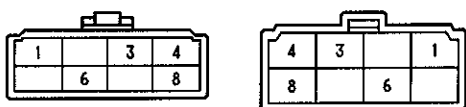

F1 黄色

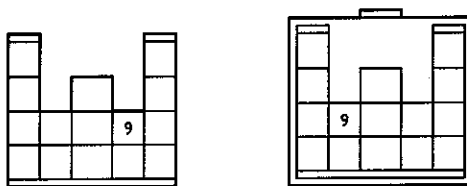

F2 黄色

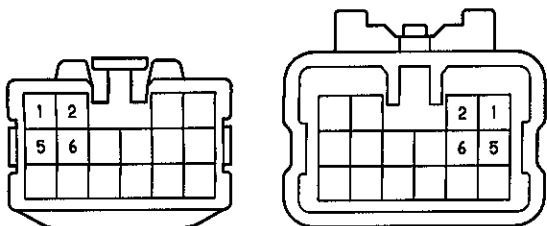

J3

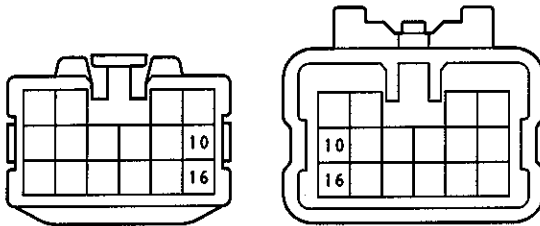

H1 M3

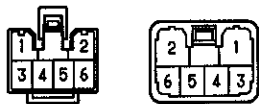



エアコンディショナ(Q, V, Zグレード)

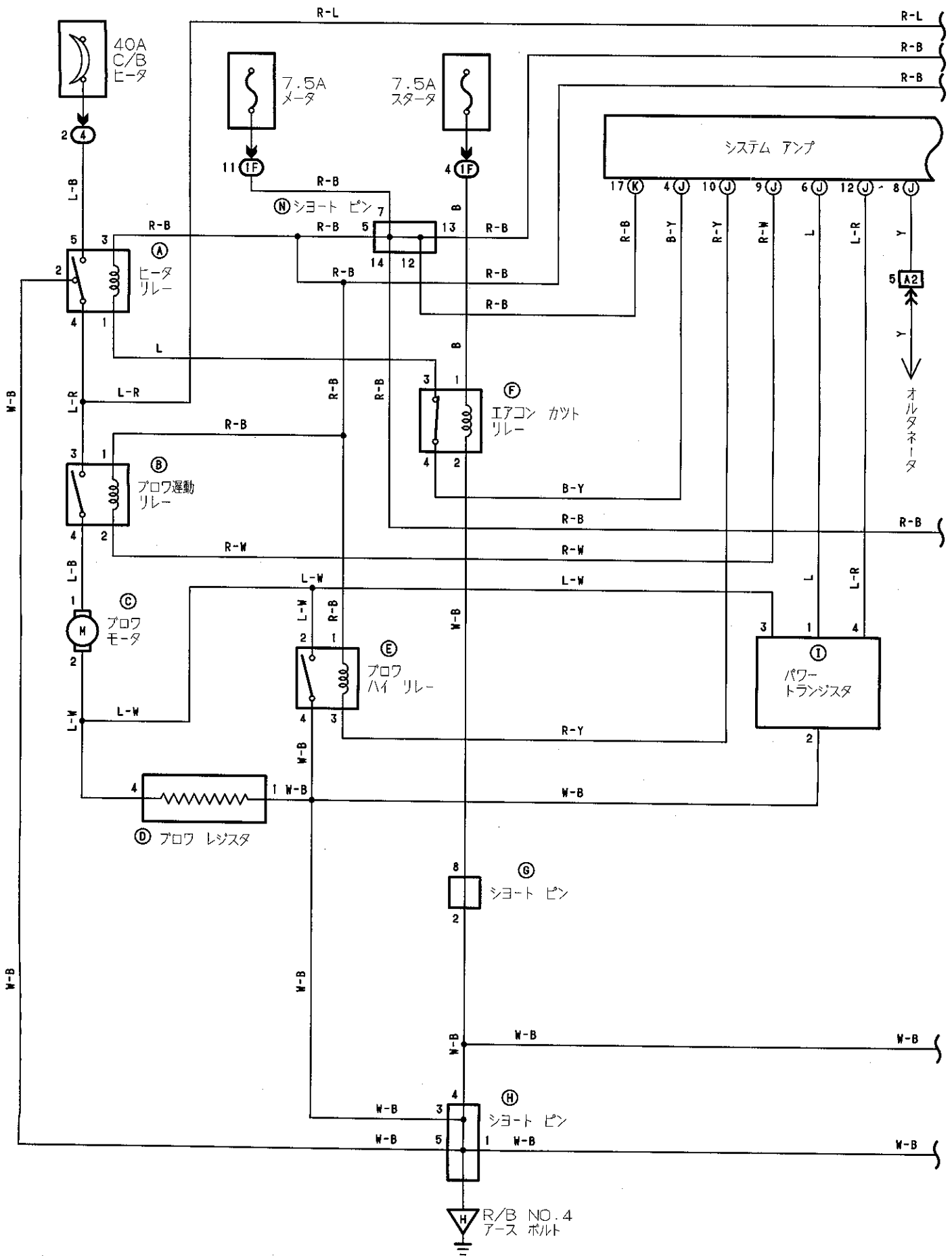

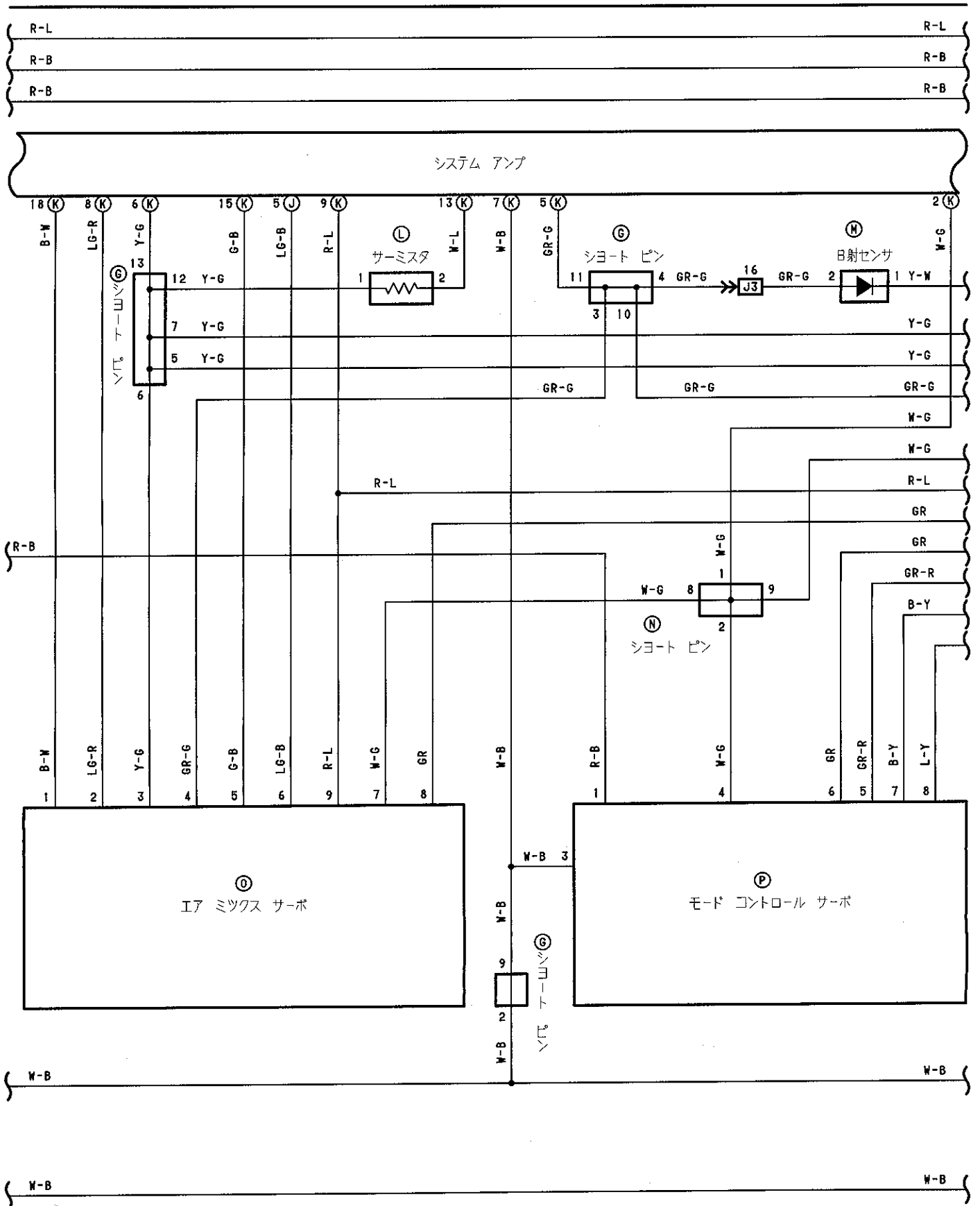



エアコンデিশヨナ(Q, V, Zグレード)

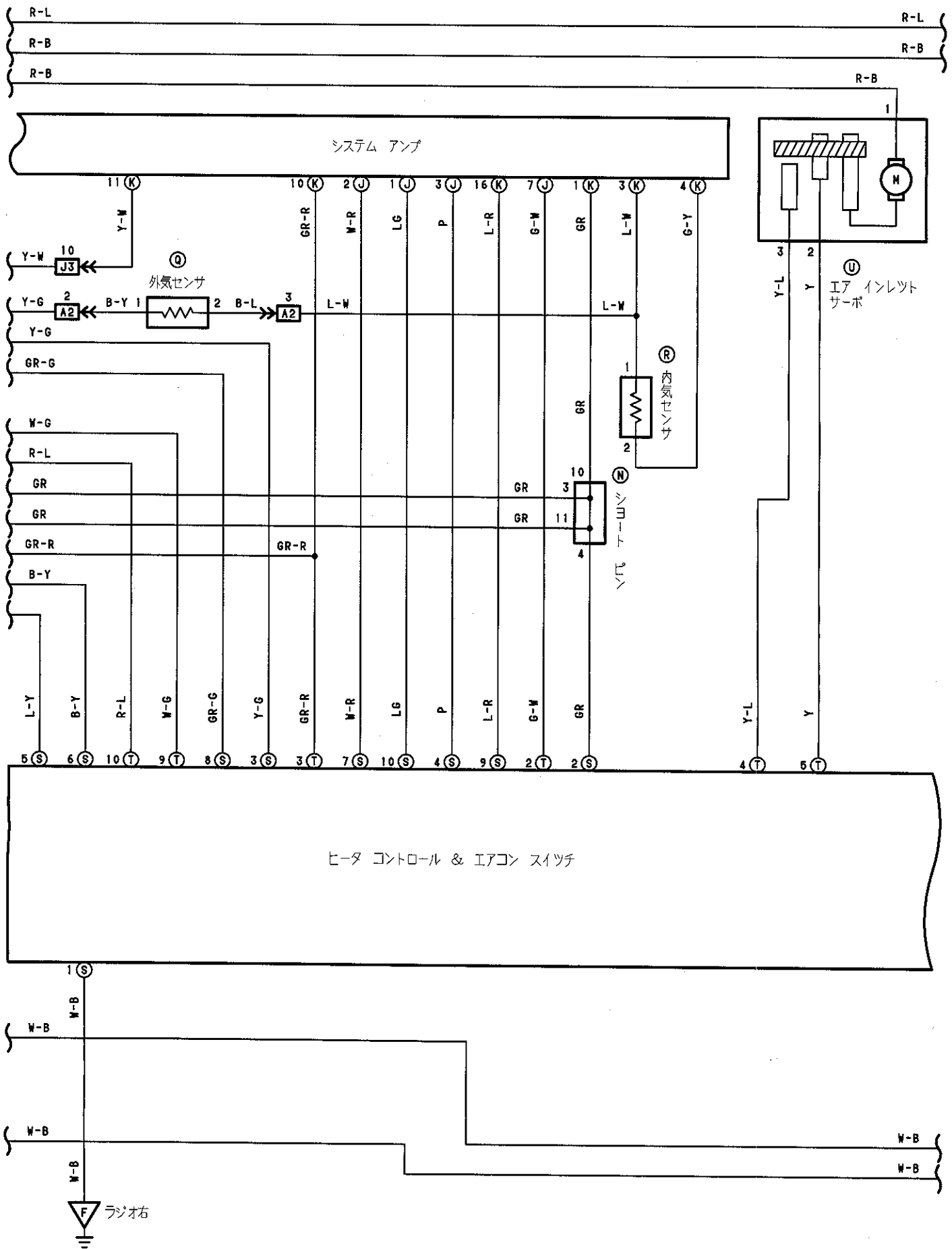

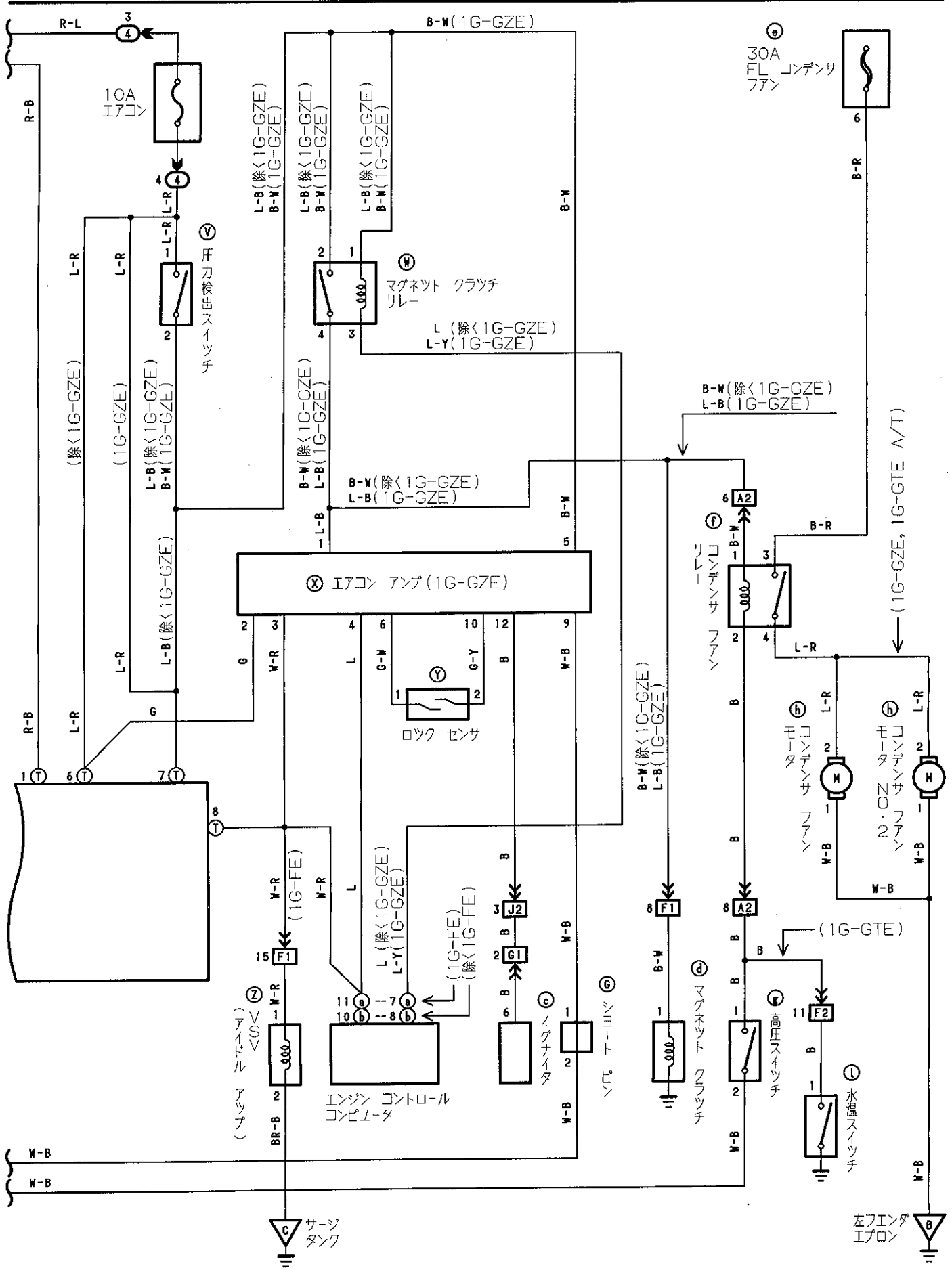



エアコンディショナ(Q, V, Zグレード)

Ⓐ



(R/B NO. 4)

Ⓑ

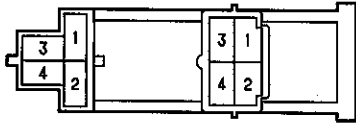

Ⓔ 黒色

Ⓒ



Ⓓ



Ⓕ



Ⓖ Ⓗ

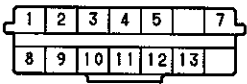

Ⓖ

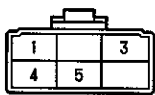

(R/B NO. 4)

Ⓘ 黒色



⓵ 黒色

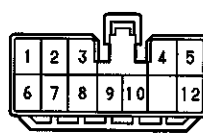

Ⓚ 黒色

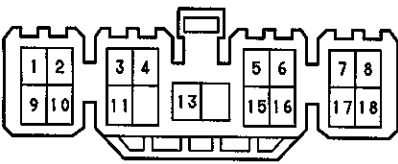

Ⓛ

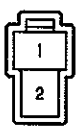

Ⓜ



Ⓝ

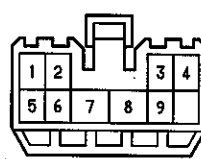

Ⓟ

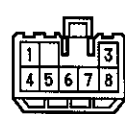

Ⓣ 黒色



Ⓡ 青色



Ⓢ 青色

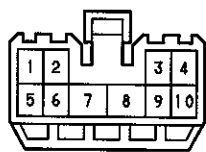

Ⓣ 青色

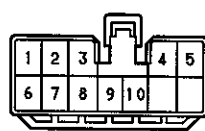

Ⓤ



Ⓥ 茶色



Ⓦ

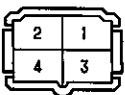

Ⓧ

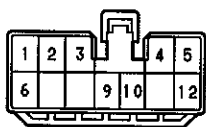

Ⓨ



Ⓩ 灰色



Ⓛ

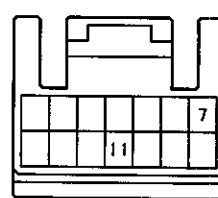

Ⓩ 灰色

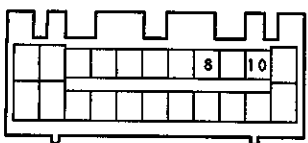

Ⓜ 灰色

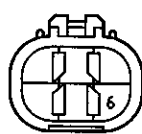

Ⓝ



Ⓝ 黒色

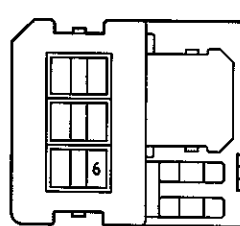

Ⓝ 灰色



Ⓝ 黒色



Ⓝ 黒色



1F

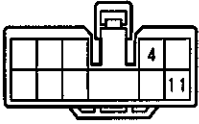

A2 灰色

F1 黄色

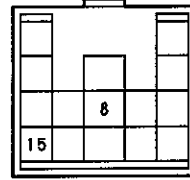
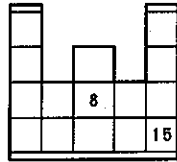
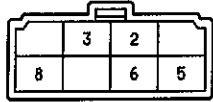

F2 黄色

G1 黄色

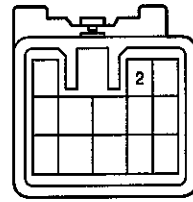
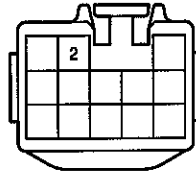
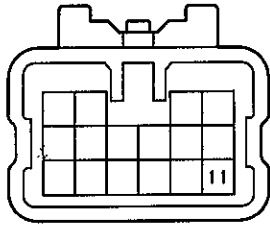
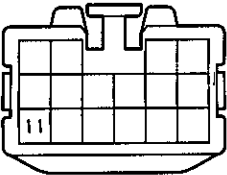

J2

J3

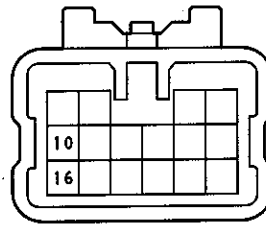
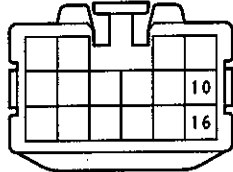

アースポイント

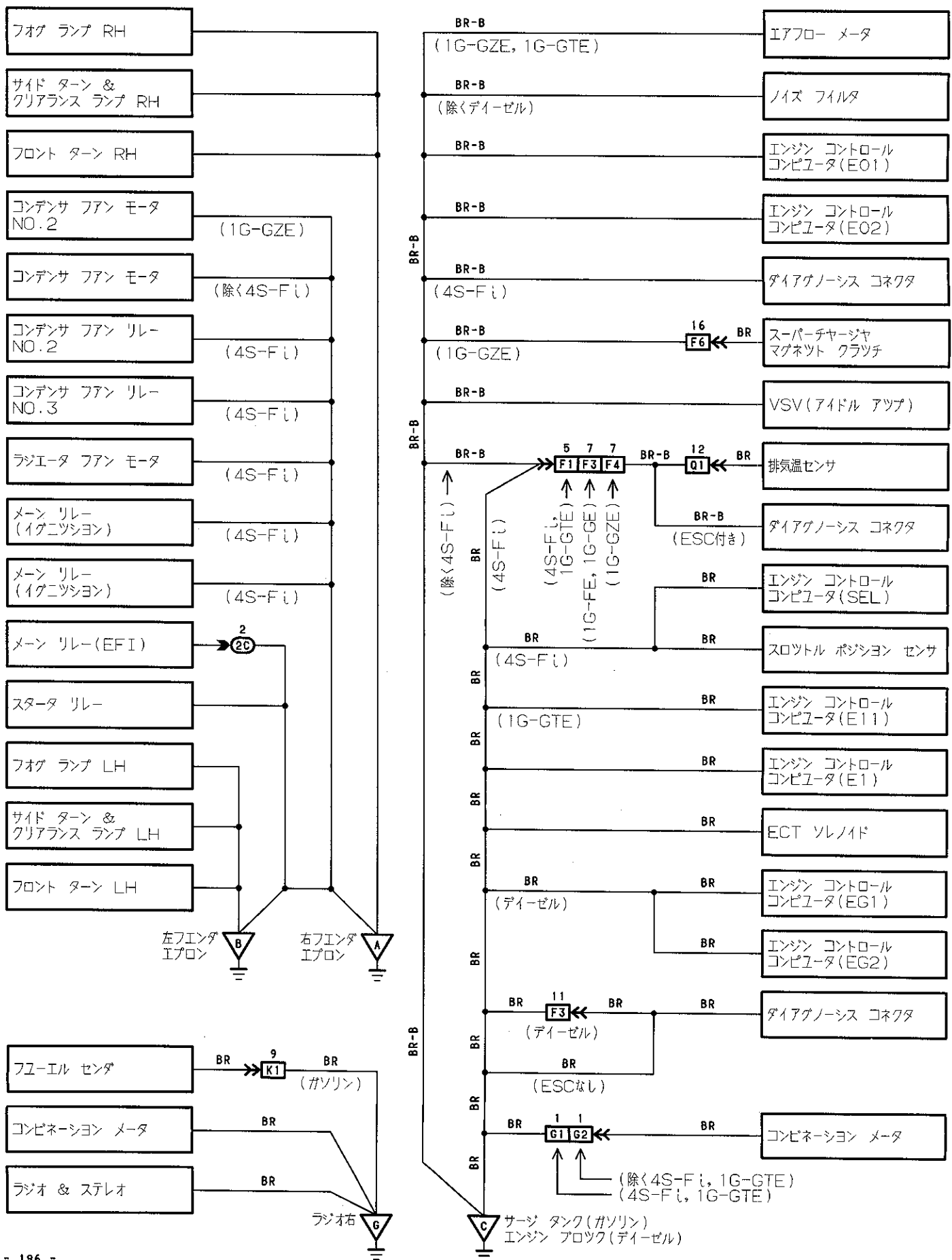

J/B NO.3

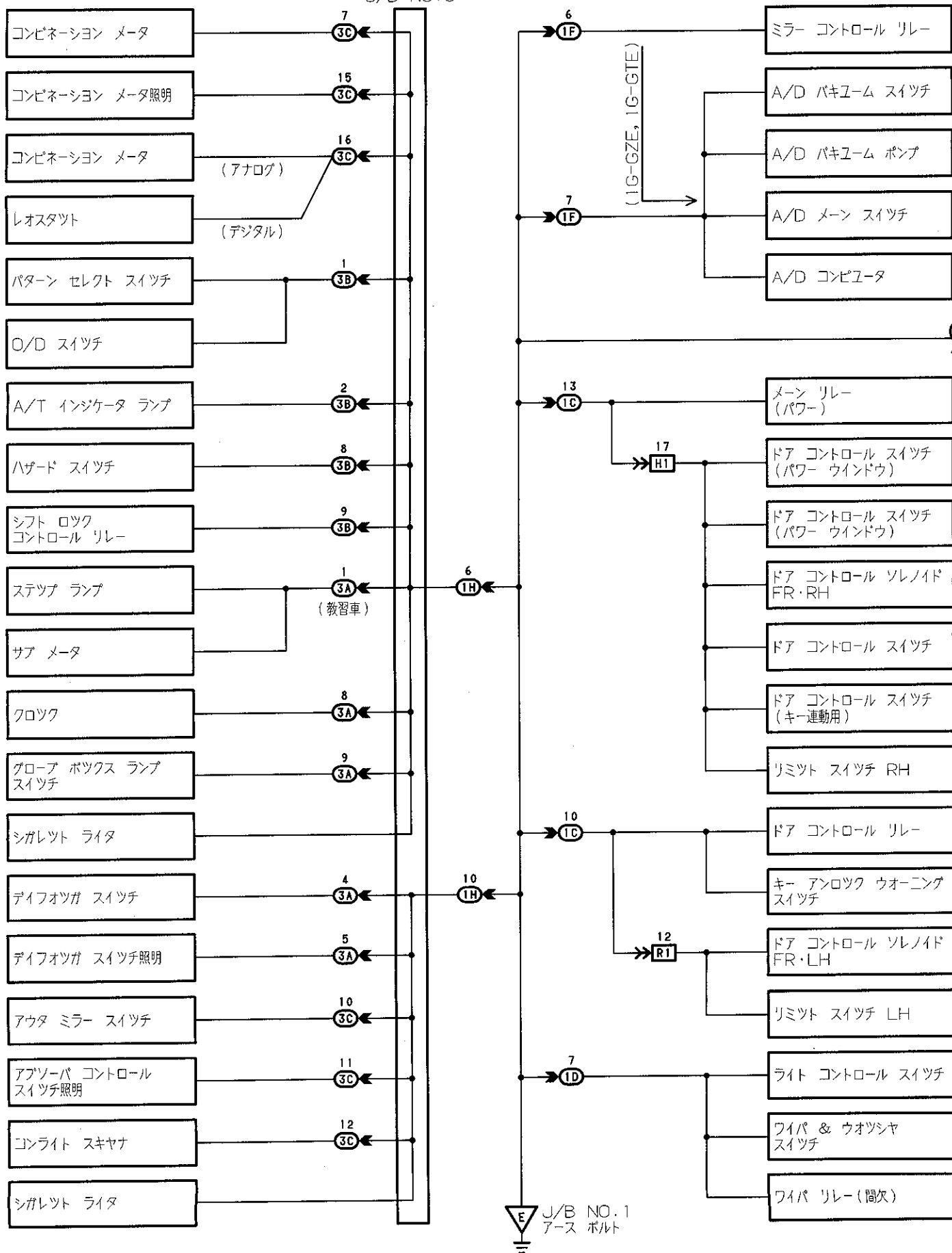

アースポイント

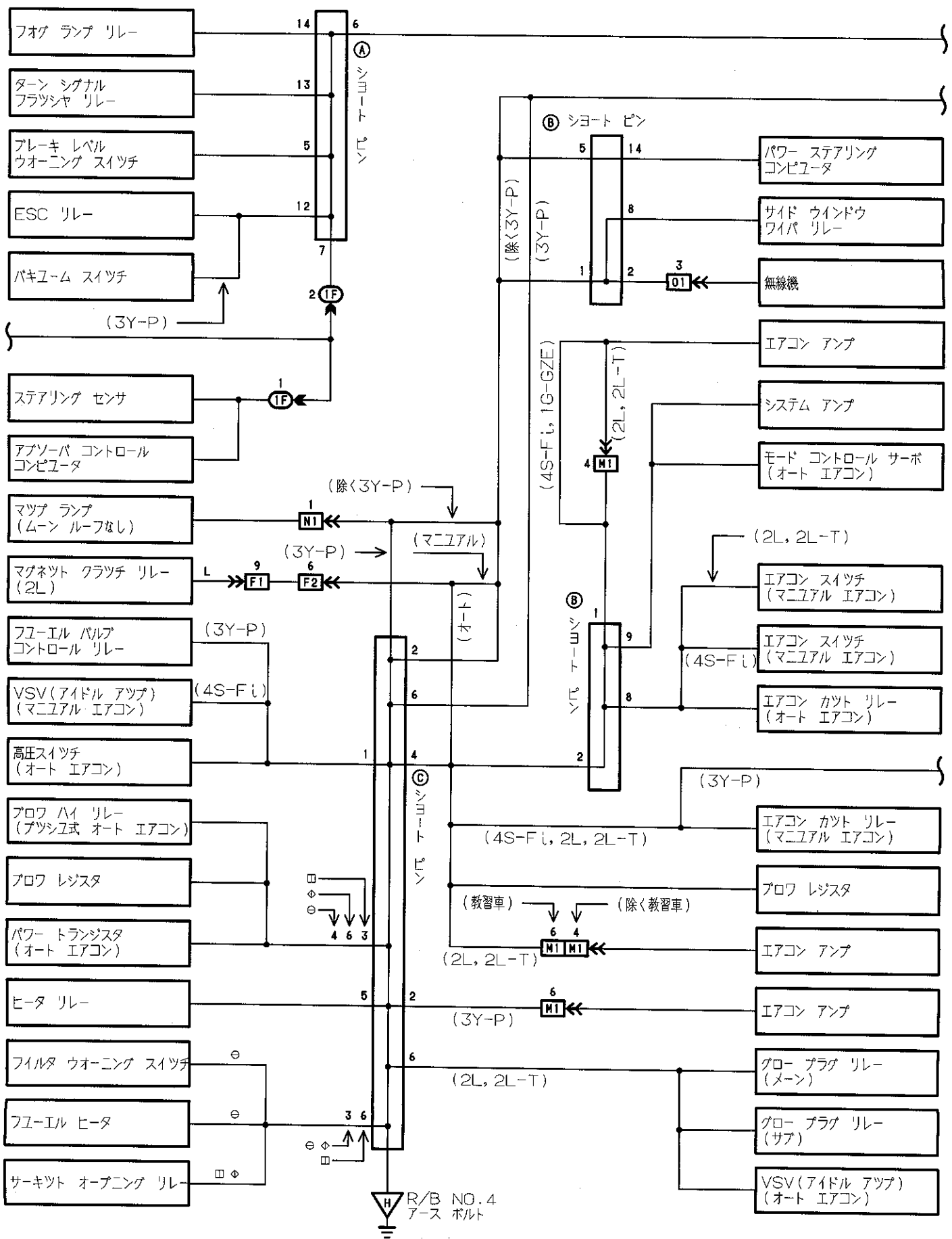

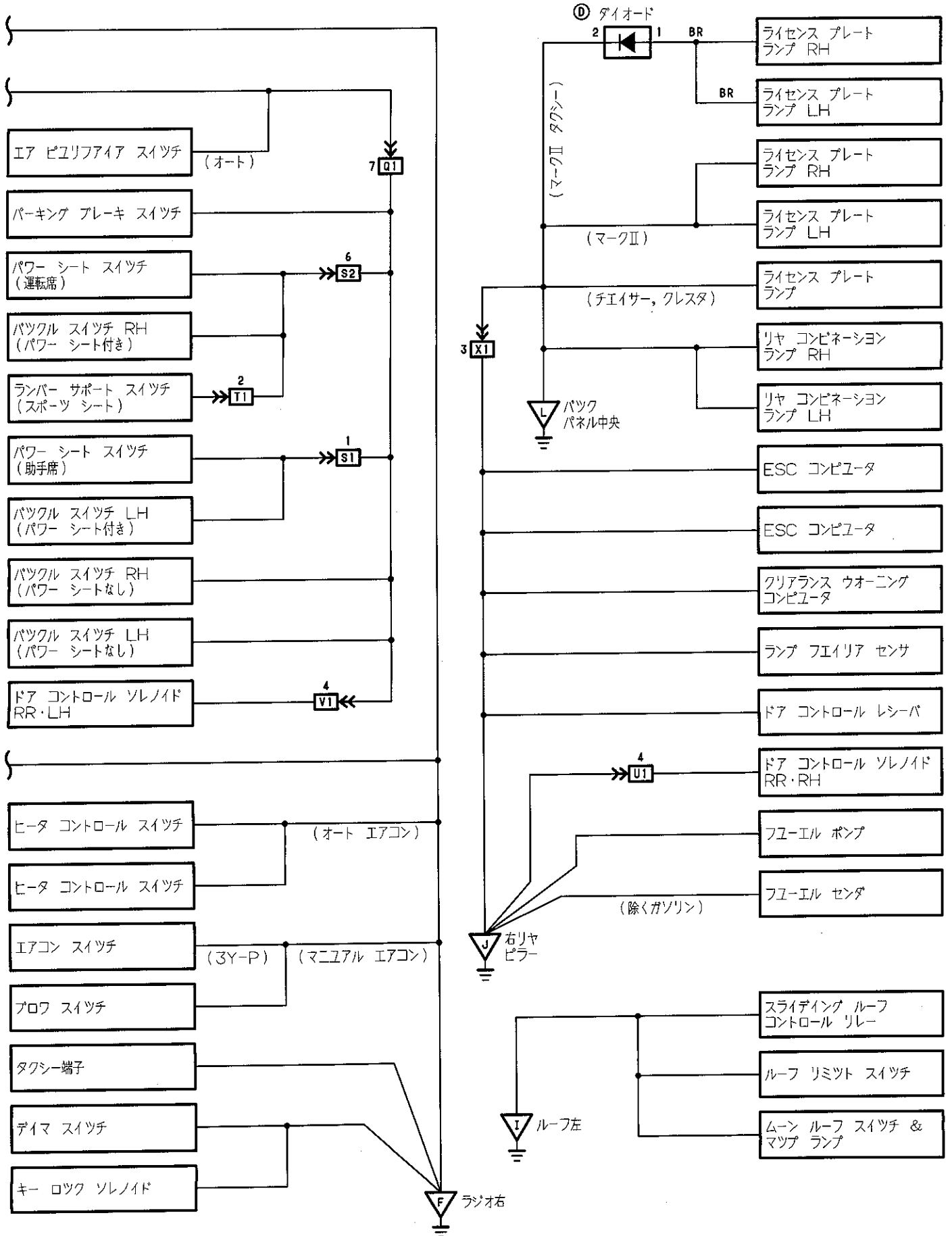

アースポイント

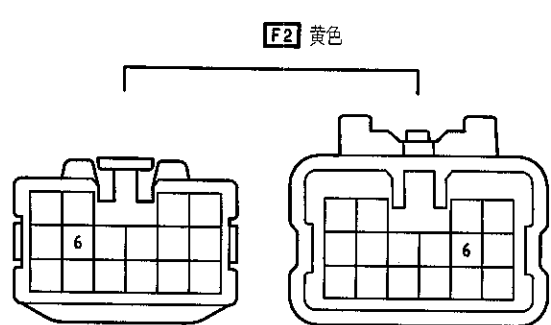
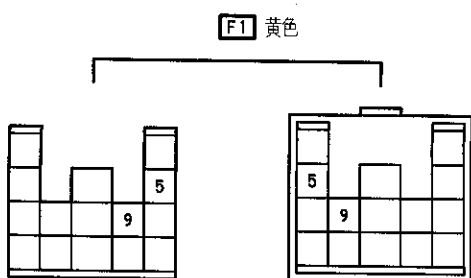
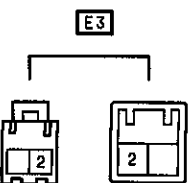
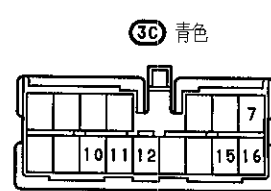
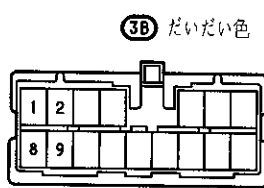
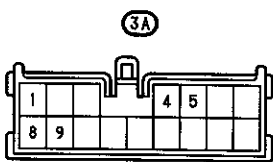
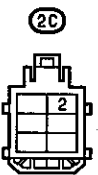
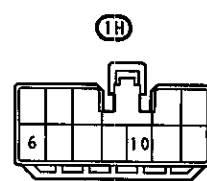
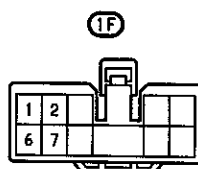
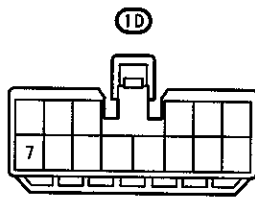
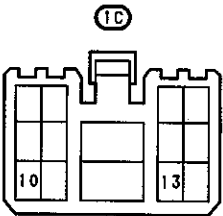
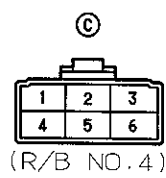
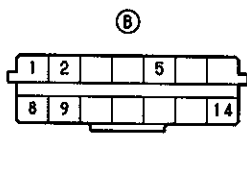
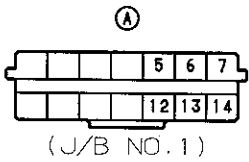
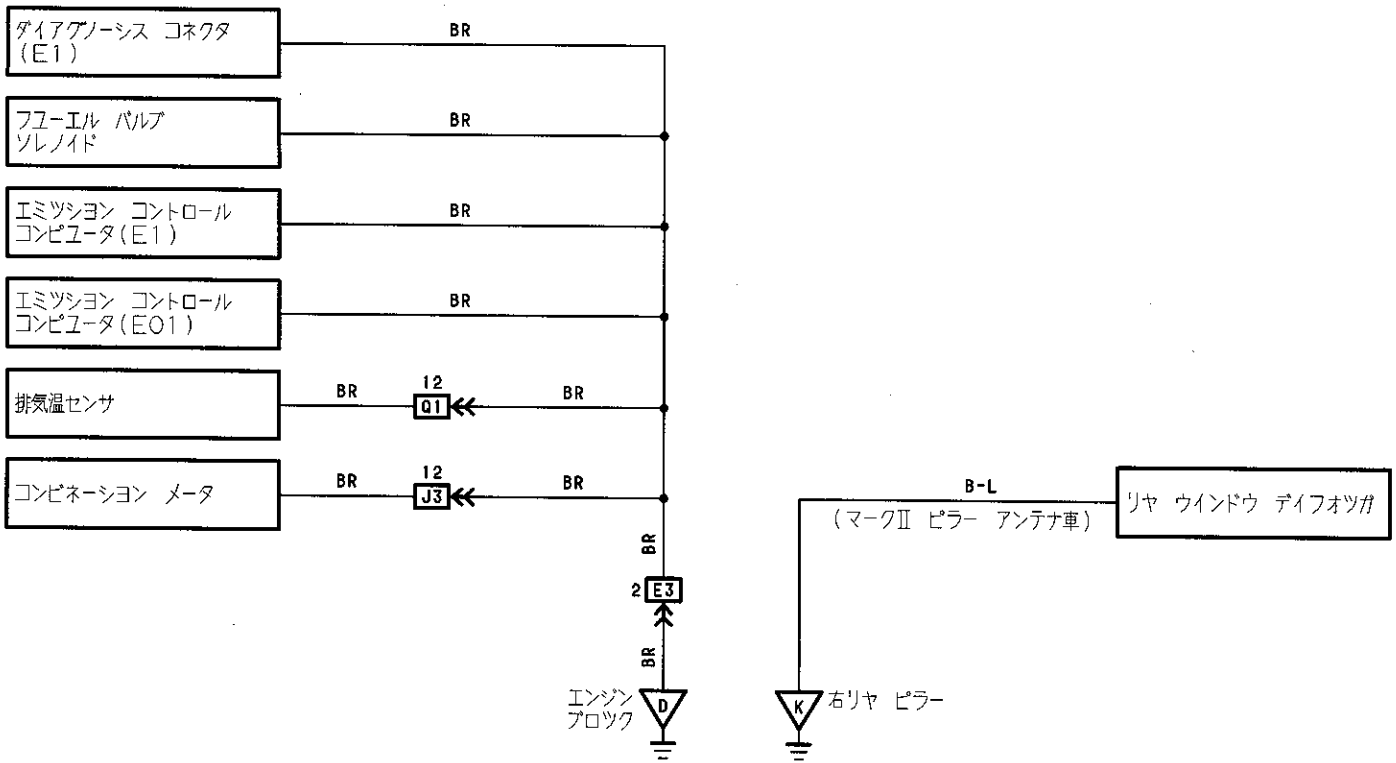

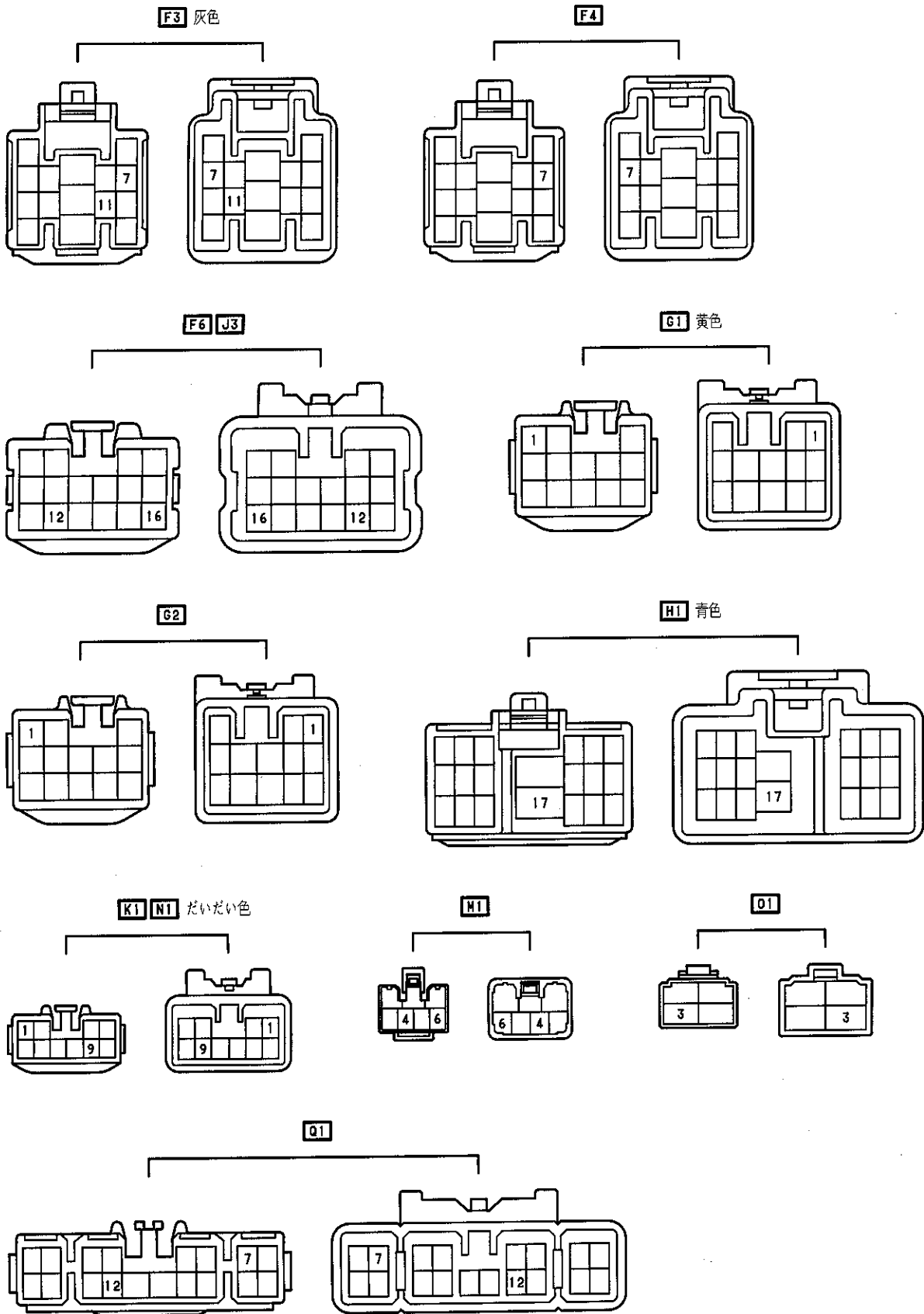

≡ アースポイント

