



## 電源(電源—負荷 参考)

### J/B NO.1(右カウル サイド)

電 源		負 荷	ページ
15 A	ストップ ランプ	ストップ ランプ スイッチ, ストップ ランプ	41
		パーキング ランプ スイッチ, パーキング ランプ	36
15 A	エレクトロニクス IG	ヒータ リレー, コンビネーション バルブ, オート エア コンディショナ, オート リレー	74, 79
		オールタネータ, ゼネレータ レギュレータ, チャージ ランプ リレー(2L)	18, 20, 22
		プレヒータリング タイマ	24
		ハンド ウォーマ リレー, ハンド ウォーマ コントロール アンブ	72
20 A	ワイパ	ワイパ モータ, ウォツシヤ モータ, ウインドシールド ワイパ リレー	50
		リヤ ワイパ モータ, リヤ ウォツシヤ モータ	52
7.5 A	ルーム ランプ	クロック	64
		ルーム ランプ, マップ ランプ, ルーム ランプ コントロール リレー, デツキ ルーム ランプ, 半ドア ウォーニング ランプ	48
15 A	テール ランプ	ハザード スイッチ照明, シガレット ライタ照明, ブロワ スイッチ照明, グローブ ボックス ランプ, コンビネーション メータ照明, デフォガ スイッチ照明, A/T インジケータ ランプ, ラジオ照明, トランスミッション インジケータ照明	38, 39
		テール ランプ, テール & パーキング ランプ, クリアランス & パーキング ランプ, ランプ フェイリア センサ	36
		クロック	64
7.5 A	ターン	ターン シグナル フラツシヤ, ターン シグナル ランプ, ターン シグナル インジケータ ランプ	46
15 A	ライタ	クロック	64
		シガレット ライタ	64
		モータ アンテナ	66
7.5 A	ライセンス	ライセンス プレート ランプ	36
7.5 A	イグニツション	チャージ ウォーニング ランプ	18, 20, 22
		エミツション コントロール コンピュータ, フューエル カット ソレノイド, OVCV, セカンダリ フューエル カット ソレノイド	28
7.5 A	ラジオ NO.2	ラジオ & ステレオ	65
		リモート コントロール アクチュエータ	57
7.5 A	メータ	コンビネーション メータ, インジケータ ランプ(LH), インジケータ ランプ(RH)	68, 69
		ランプ フェイリア センサ	44
		O/D OFF インジケータ ランプ, O/D ソレノイド	60
		モータ アンテナ	66
		バック アップ ランプ	42
30 A	C/B デフォガ	リヤ ウインド デフォガ	53

### J/B NO.2(エンジン ルーム)

電 源		負 荷	ページ
7.5A	チャージ	電熱子ヨーク	28
		オルタネータ, チャージ ウォーニング ランプ, ゼネレータ レギュレータ	18, 20, 22
15A	ラジオ NO.1	ラジオ & ステレオ	65
		モータ アンテナ	66
15A	ヘッドランプ(左)	ヘッドランプ(LH), ハイ ビーム インジケータ ランプ	34
15A	ヘッドランプ(右)	ヘッドランプ(RH), ハイ ビーム インジケータ ランプ	34
15A	ハザード・ホーン	ハザード スイッチ, ハザード ウォーニング ランプ	46
		ホーン	64
15A	EFI	メイン リレー(EFI), サーキット オープニング リレー, エンジン コントロール コンピュータ	30
40A	AM1	イグニッション スイッチ(AM1)	14, 16, 24
		オルタネータ	18, 20, 22
		フューエル ヒータ リレー, フューエル ヒータ	27
30A	AM2	イグニッション スイッチ(AM2)	14, 16
80A	ALT	テール ランプ リレー	36
		スタータ リレー	16
		オルタネータ	18, 20, 22
		ハンド ウォーマ ユニット	72
80A	GLOW	グロー プラグ リレー(メイン), グロー プラグ リレー(サブ)	24

### J/B NO.4(左カウル サイド)

10A	エアコン	エア コンディショナ スイッチ	74, 78
30A	C/B ヒータ	ヒータ リレー, ブロワ モータ	74, 79

### ヒューズブル リンク(バッテリー横)

2.0L	FL メーン	ヘッドランプ リレー	34
------	--------	------------	----

### サーキット ブレーカ(右カウル サイド)

30A	C/B パワー	パワー ウインド リレー, パワー ウインド マスタ スイッチ, パワー ウインド モータ	54
30A	C/B ドア ロック	ドア ロック コントロール リレー, ドア ロック ソレノイド, バック ドア ロック ソレノイド	58



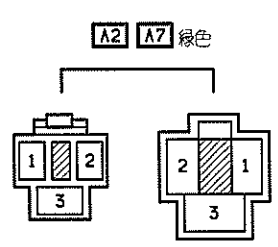
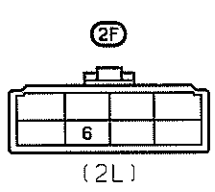
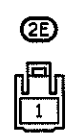
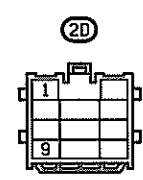
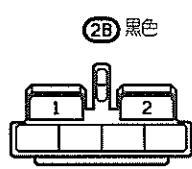
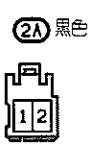
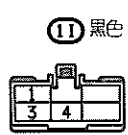
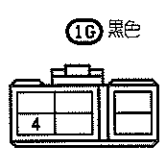
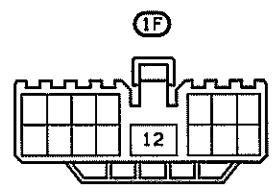
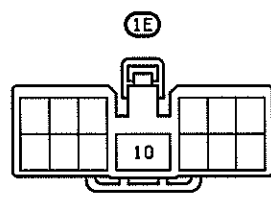
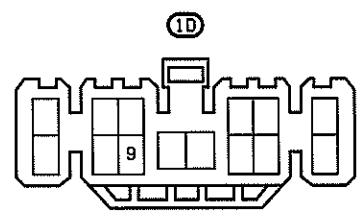
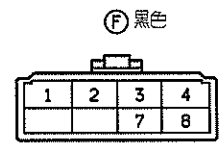
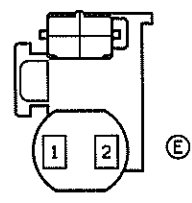
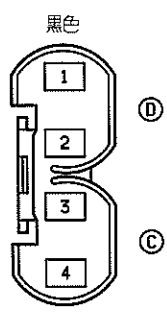
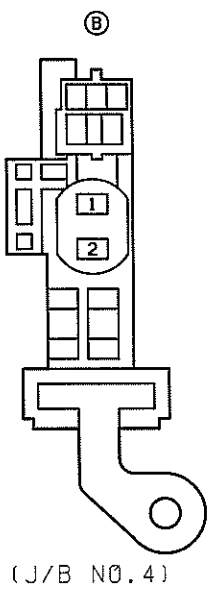
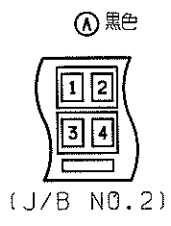



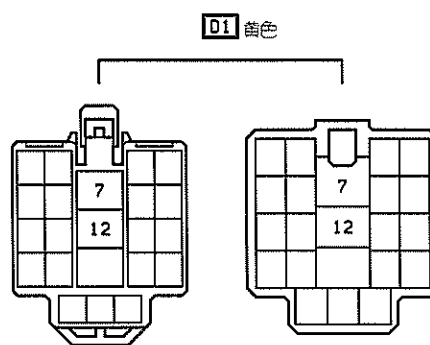
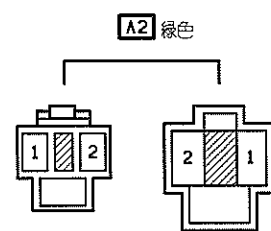
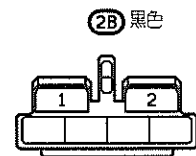
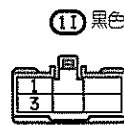
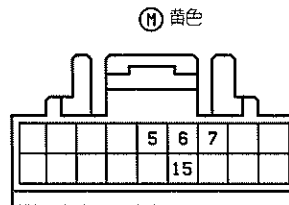
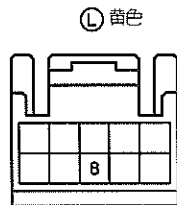
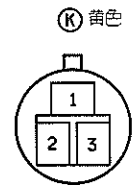
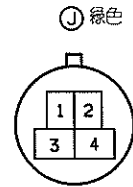
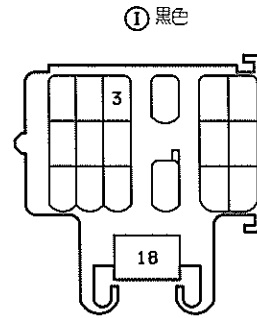
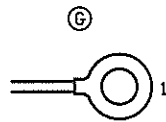
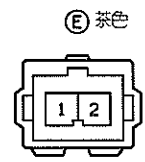
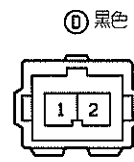
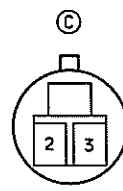
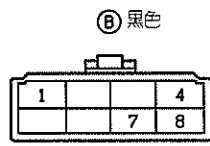
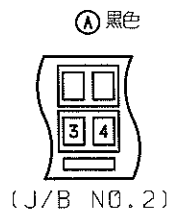



# スターティング & イグニッション (2Y-J, 2L)

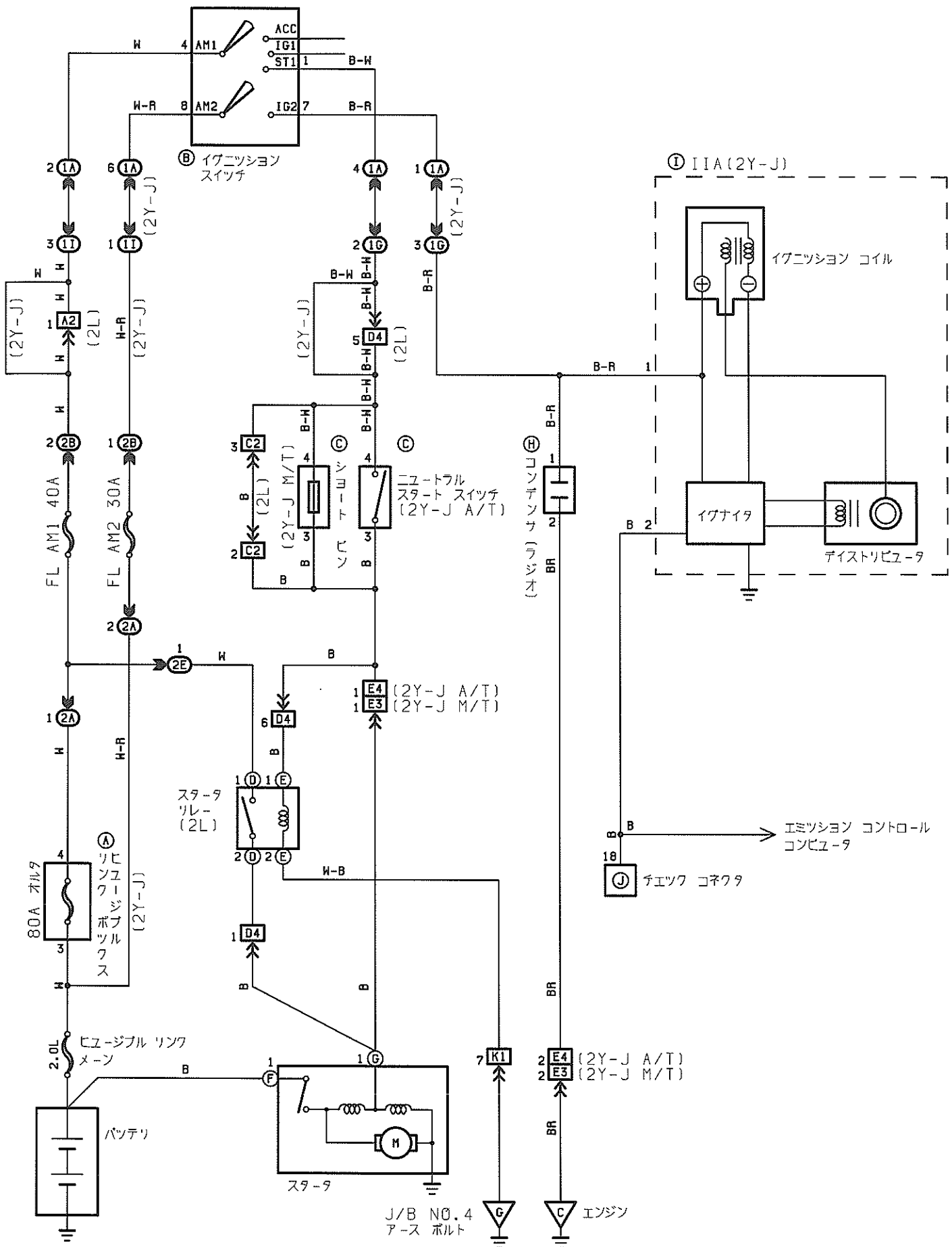

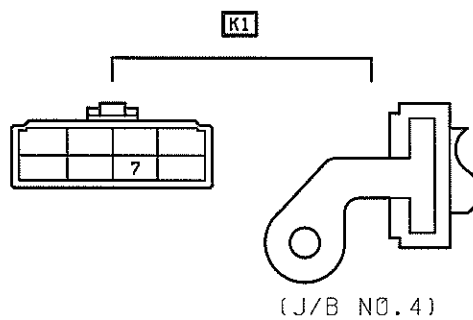
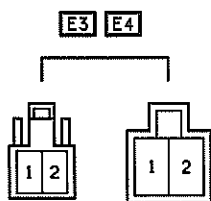
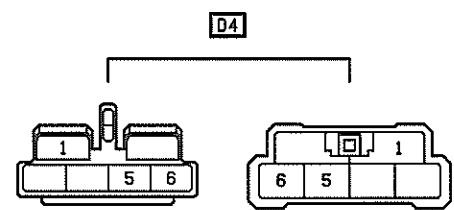
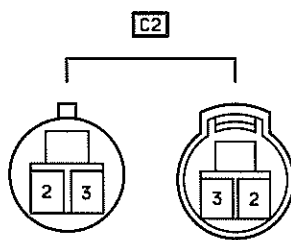
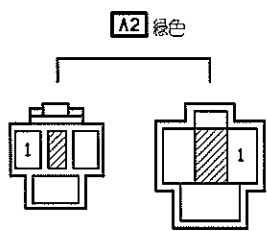
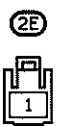
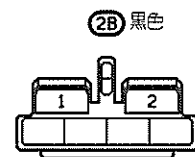
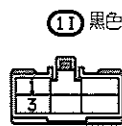
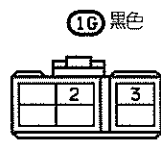
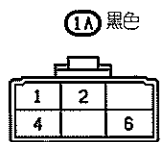
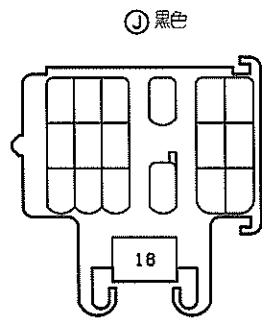
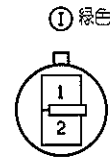
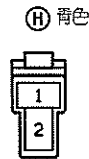
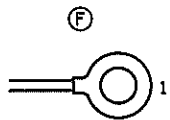
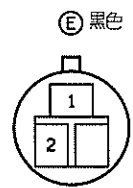
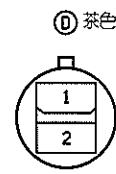
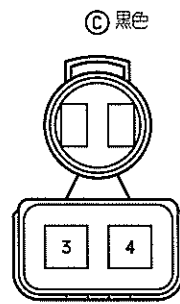
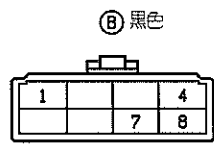



# 充電(1G-EU)

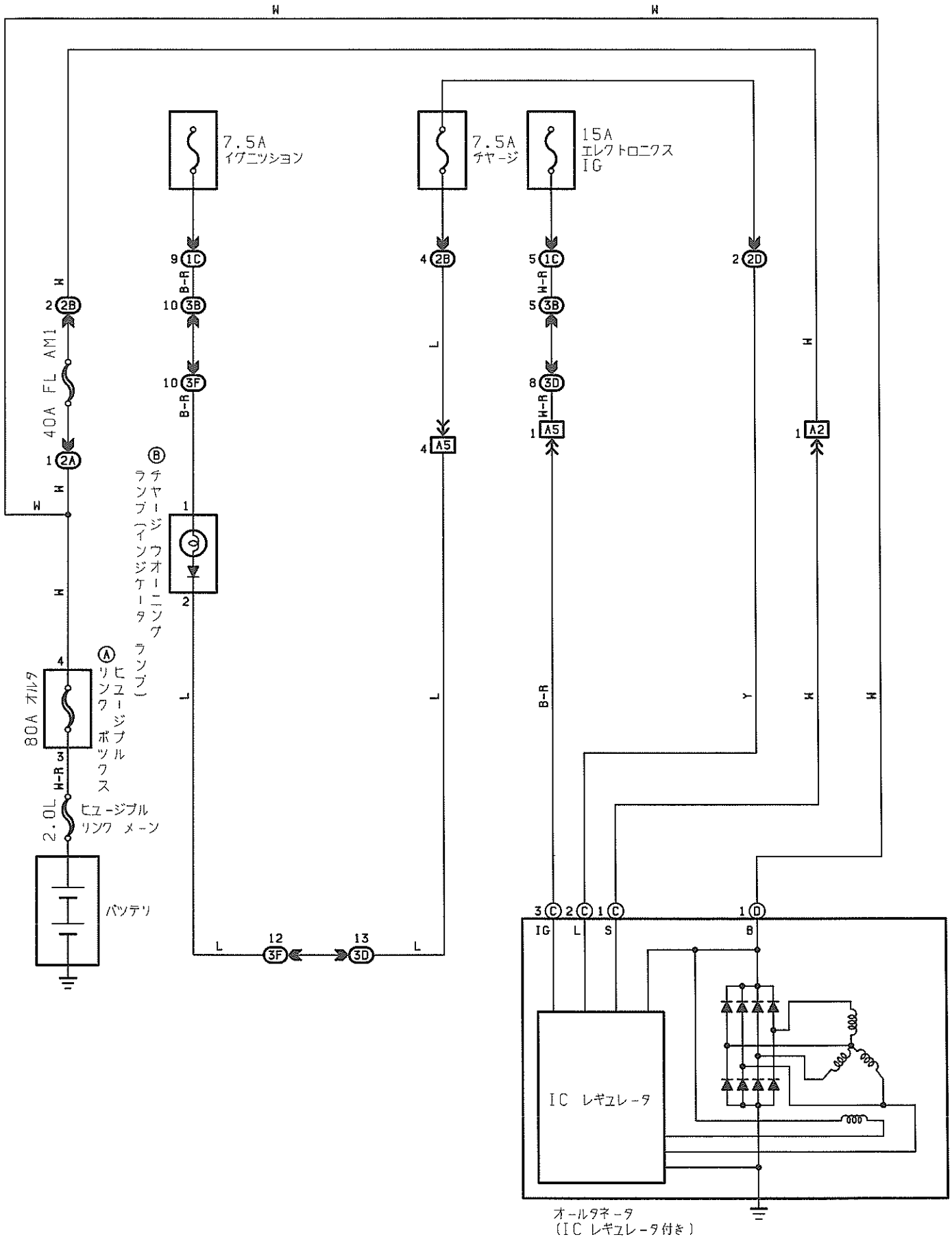

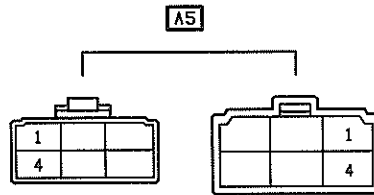
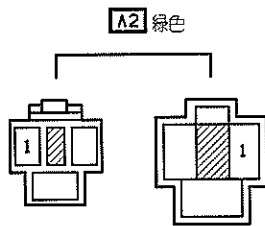
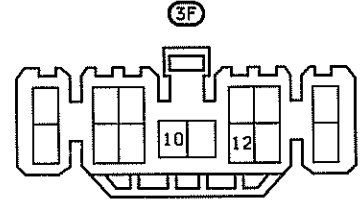
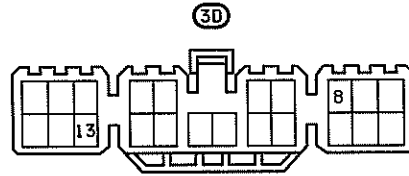
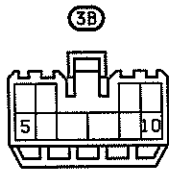
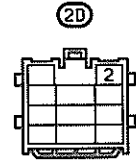
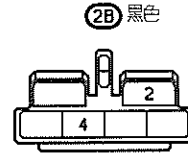
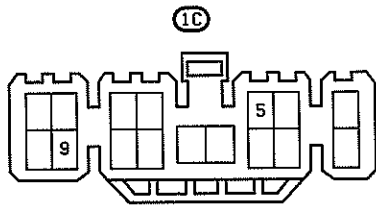
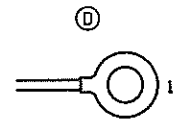
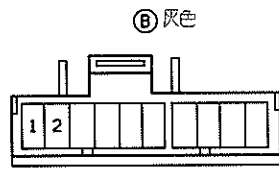
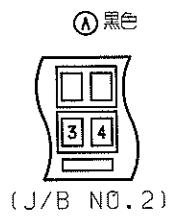



# 充電(2Y-J)

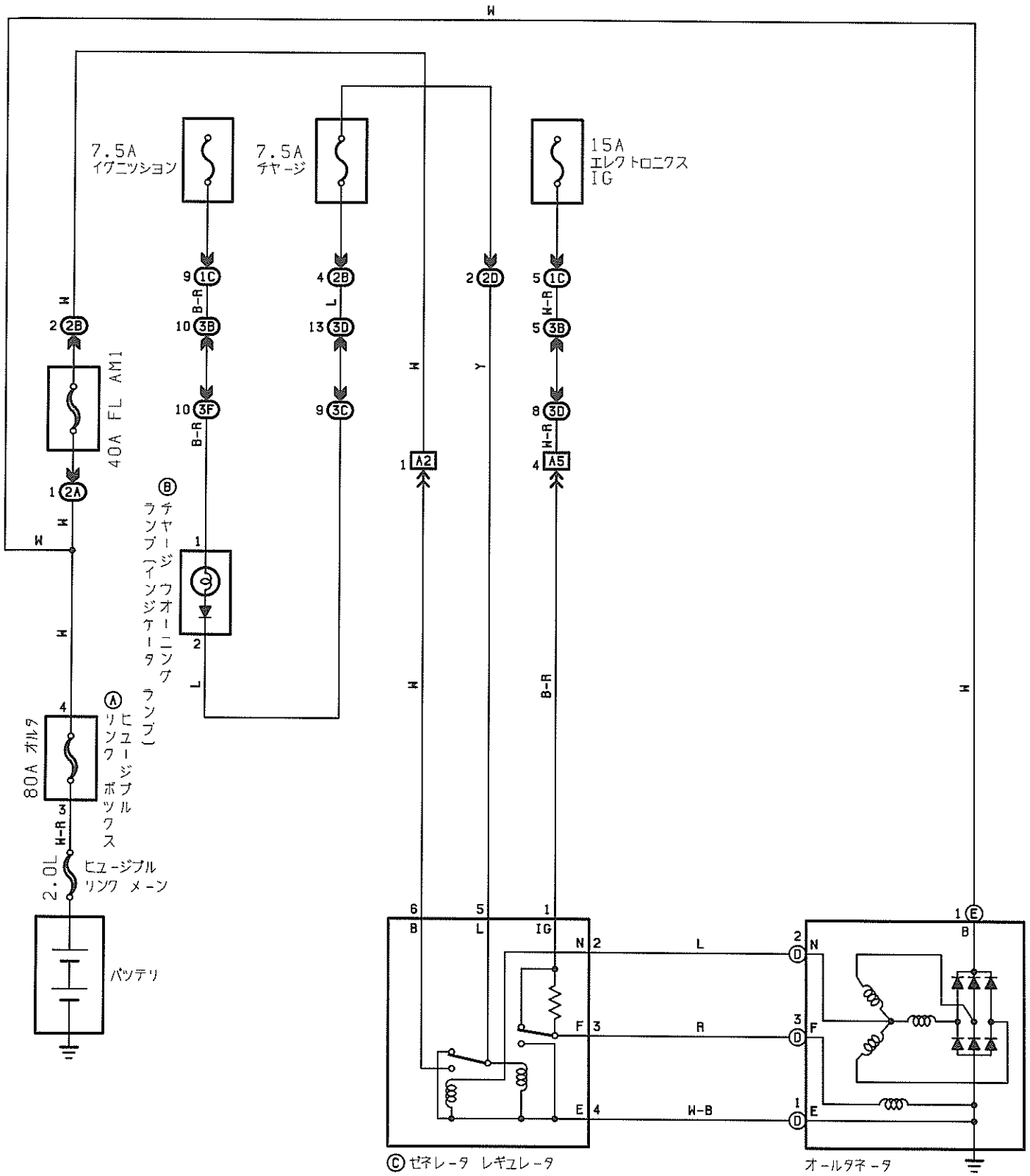

Ⓐ 黒色

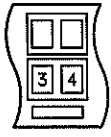

(J/B N0.2)

Ⓑ 灰色

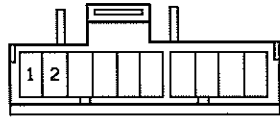

Ⓒ 緑色

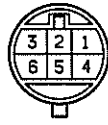

Ⓓ 黒色

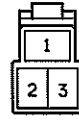

Ⓔ



1C

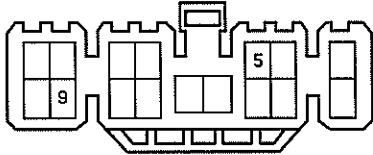

2A 黒色



2B 黒色

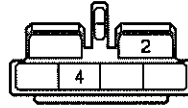

2D

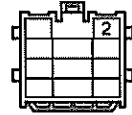

3B

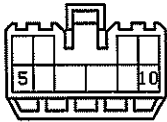

3C

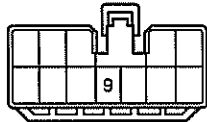

3D

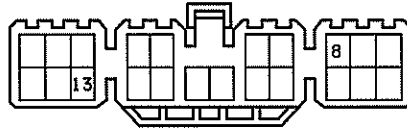

3F

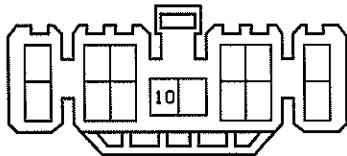

A2 緑色

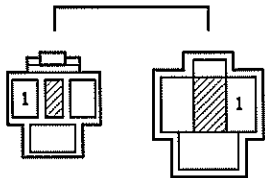

A5

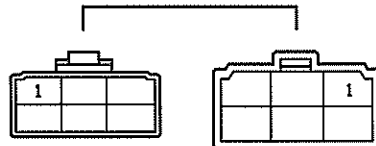



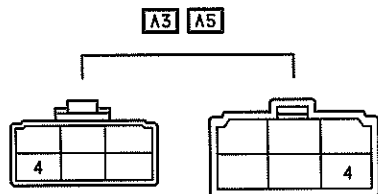
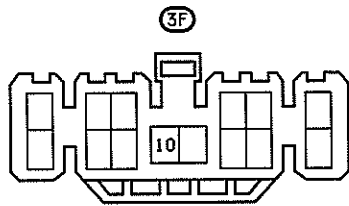
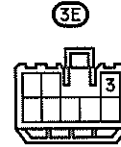
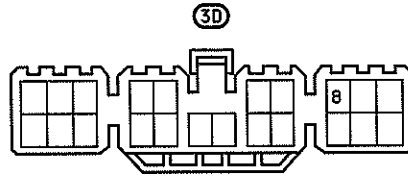
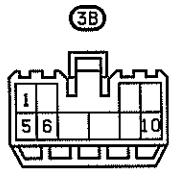
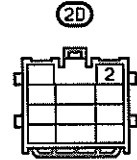
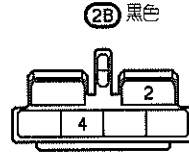
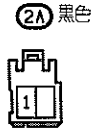
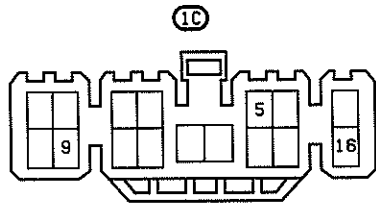
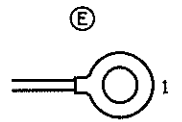
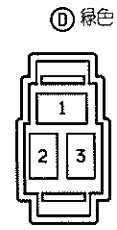
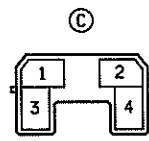
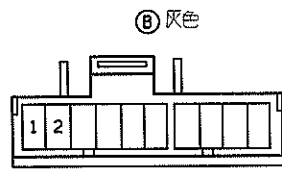

# グロー (急速グロータイプ)

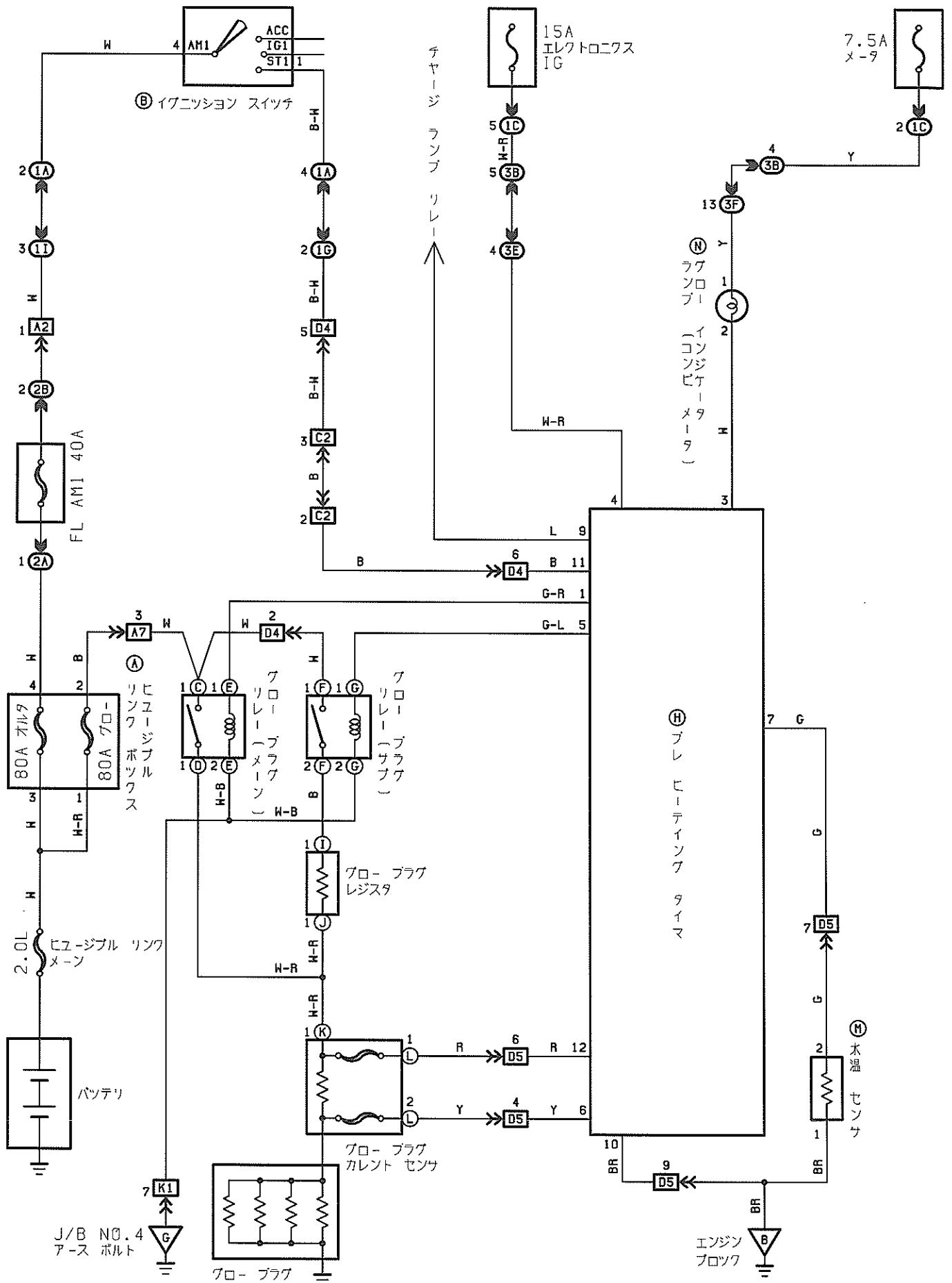

④ プレ ヒーテング タイマ

(イグニッション スイッチ ON)

1- ボデー アース: 12V

: 0V (数秒後)

4- ボデー アース: 12V

5- ボデー アース: 12V

Ⓐ 黒色



(J/B NO.2)

Ⓑ 黒色

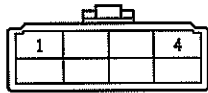

Ⓒ Ⓓ Ⓘ Ⓙ Ⓚ



Ⓔ



Ⓕ 灰色



Ⓖ 青色

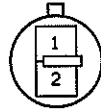

Ⓗ

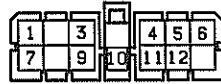

Ⓛ 黒色

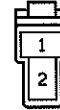

Ⓜ 緑色



Ⓝ

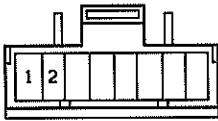

ⓁⒶ 黒色

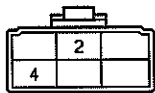

ⓁⒸ

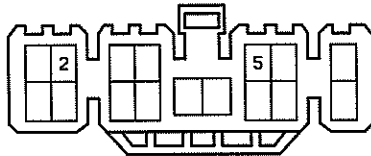

ⓁⒹ 黒色



ⓁⒿ 黒色

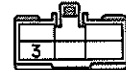

ⓂⒶ 黒色



ⓂⒷ 黒色

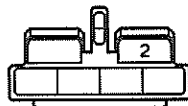

ⓂⒸ

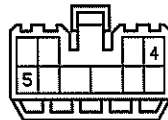

ⓂⒺ



ⓂⒻ

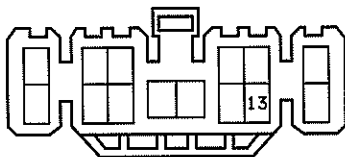

✂ グロー(急速グロータイプ)

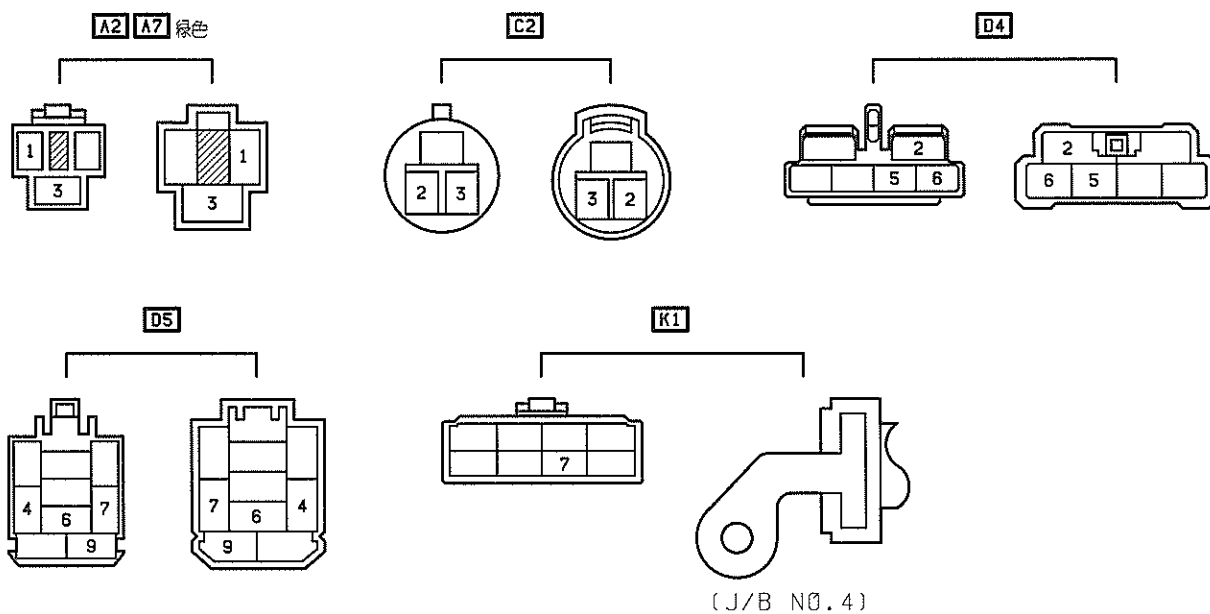

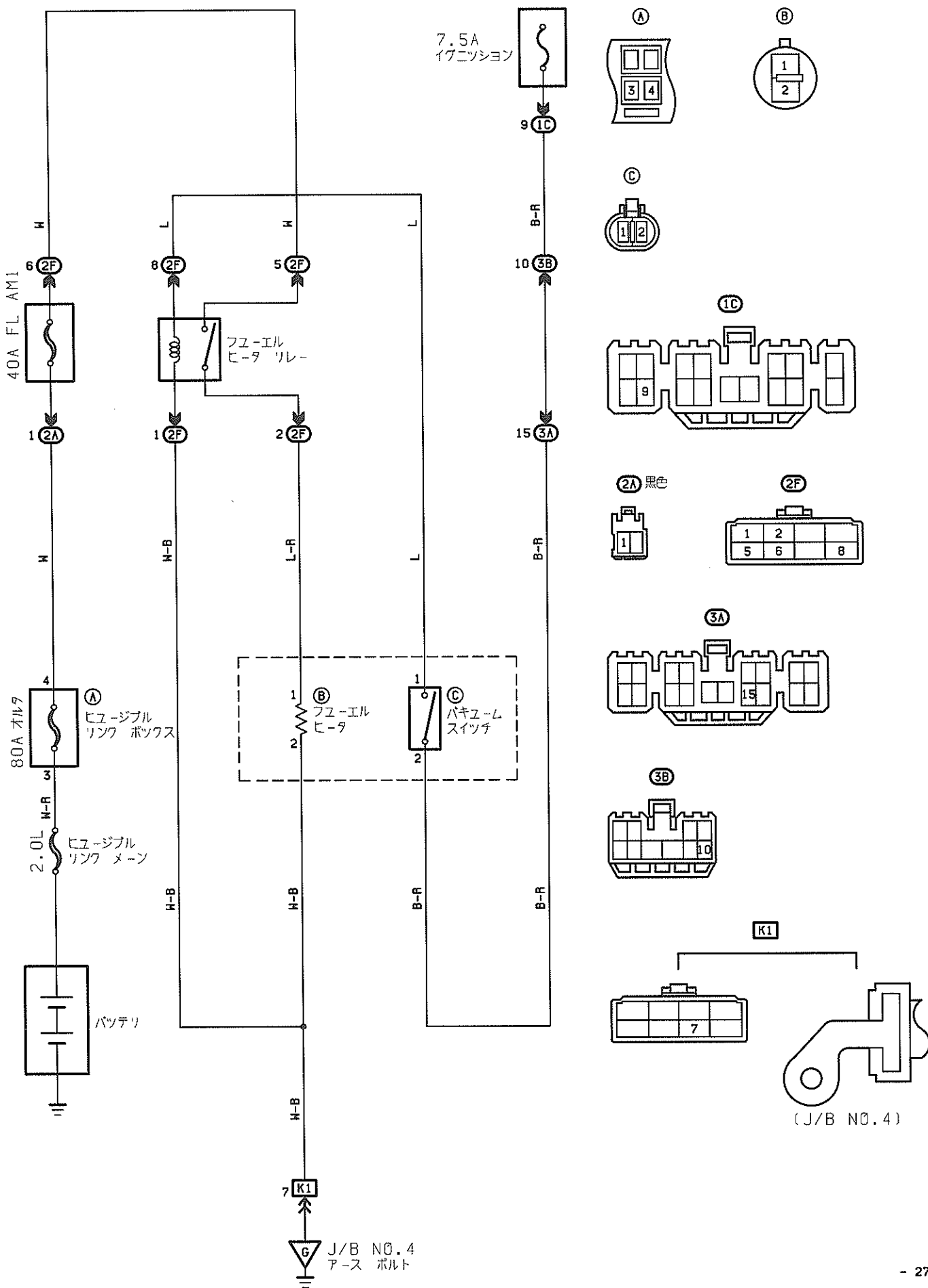



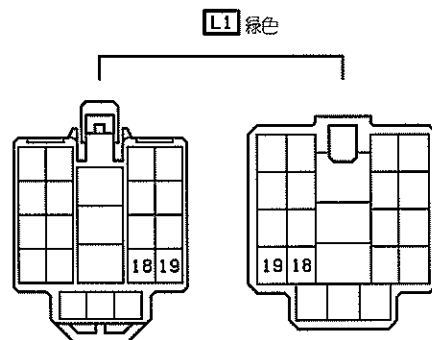
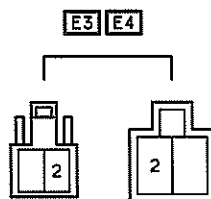
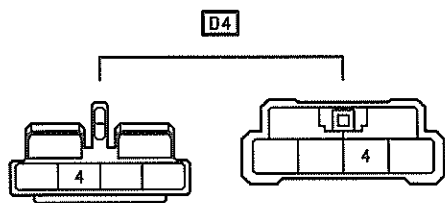
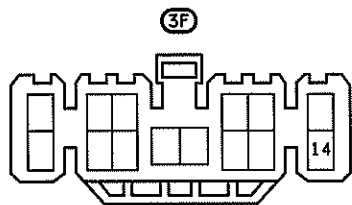
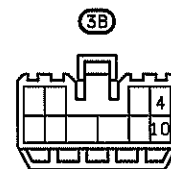
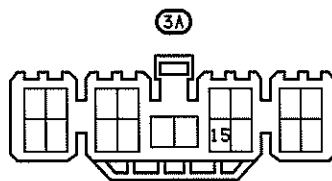
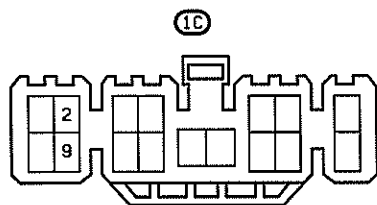
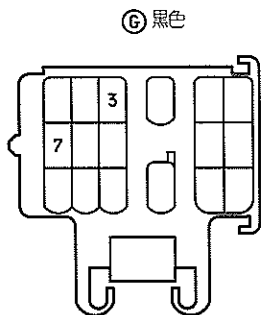
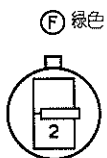
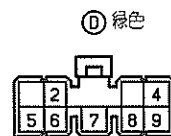
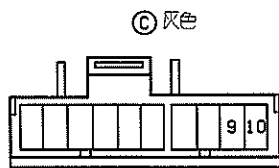
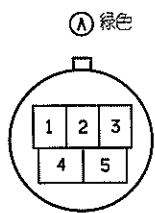

# EFI (1G-EU)

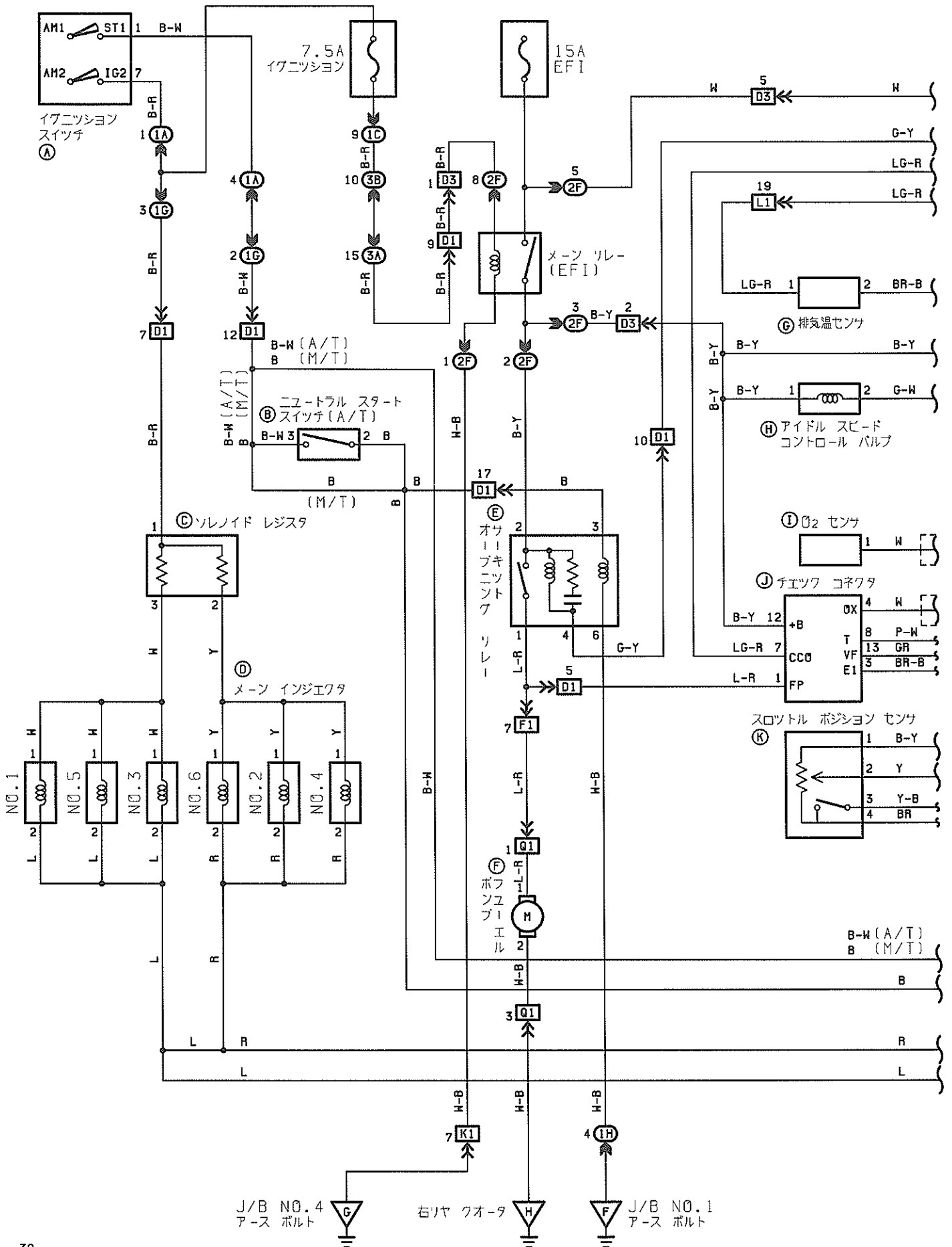

エンジンコントロール  
コンピュータ

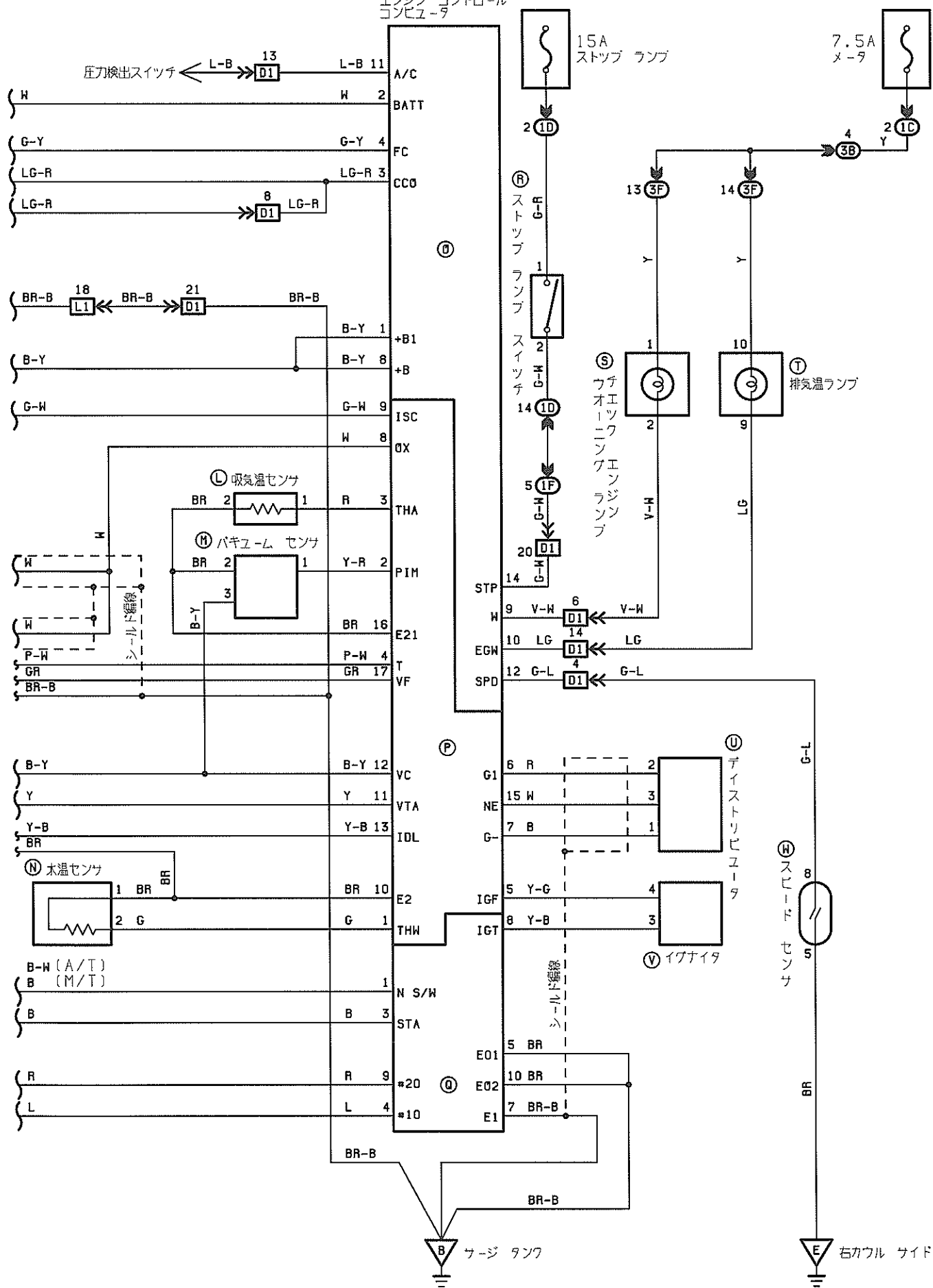

エンジン コントロール コンピュータ

<イグニッション スイッチ ON, エンジン停止>

- ② 2, ② 14-② 7:12V
- ③ 13-③ 10:0V (スロットル バルブ全閉)  
:5V (スロットル バルブ全開)
- ④ 11-④ 10:0.5V (スロットル バルブ全閉)  
:5V (スロットル バルブ全開)
- ⑤ 12-⑤ 10:5V
- ⑥ 2-⑥ 10:3.6V (バキューム センサ大気開放)  
:2.8V (バキューム センサ負圧200mmHg)
- ⑦ 4-⑦ 10:12V
- ⑧ 10-⑧ 7:0 ~ 3V (排気ウォーニング ランプ点灯)  
<クランキング>
- ⑨ 3-⑨ 7:9 ~ 11V
- ⑩ 4-⑩ 7:0 ~ 3V
- ⑪ 1-⑪ 7:9 ~ 11V  
<アイドル回転時>
- ⑫ 3-⑫ 10:2.4V (ふん囲気温度20°C)
- ⑬ 1-⑬ 10:0.5V (冷却水温80°C)
- ⑭ 9-⑭ 7:14V
- ⑮ 4-⑮ 7:0 ~ 3V
- ⑯ 10-⑯ 7:14V
- ⑰ 1-⑰ 7:9 ~ 11V
- ⑱ ナーキット オープニング リレー  
3-6:30 ~ 60Ω  
2-4:80 ~ 120Ω

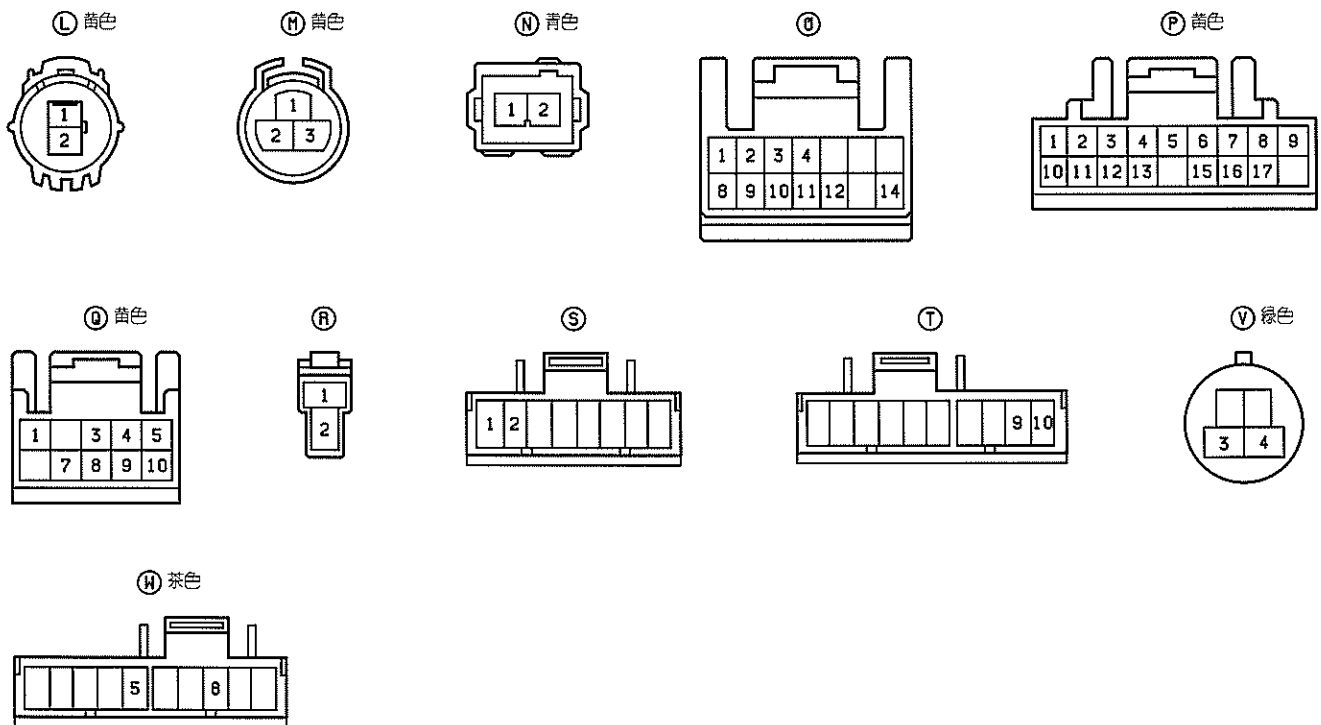
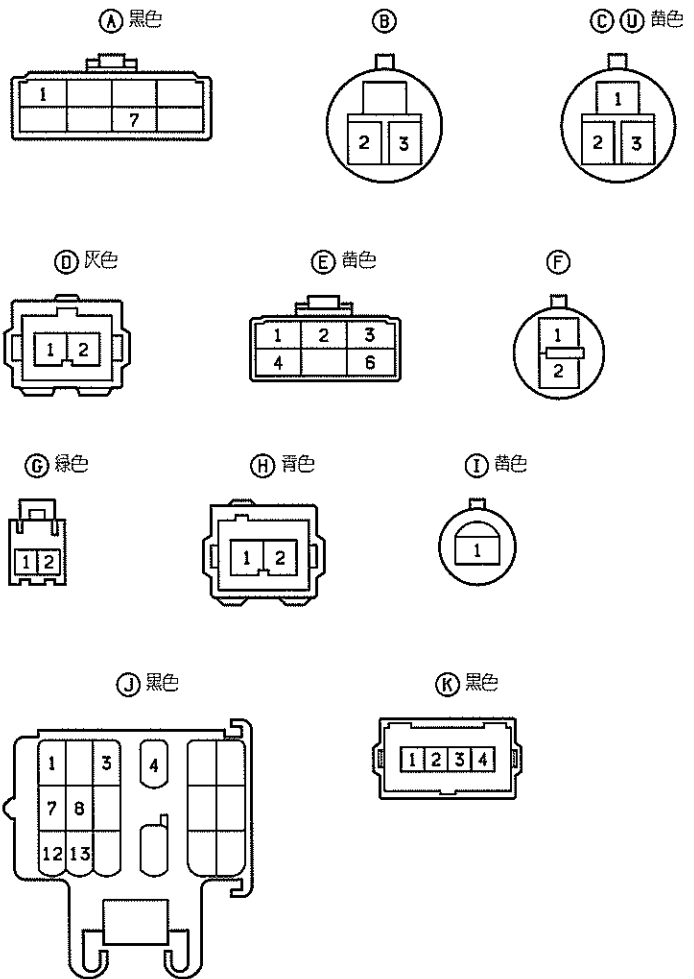

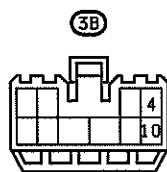
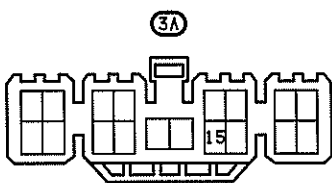
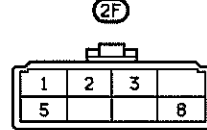
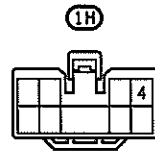
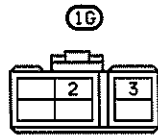
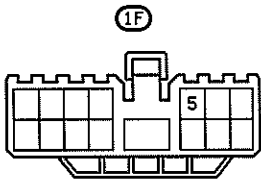
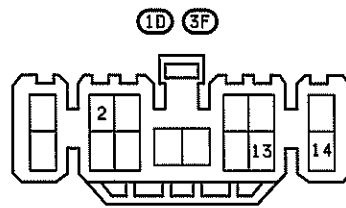
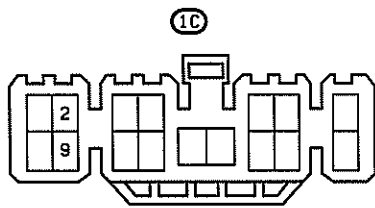
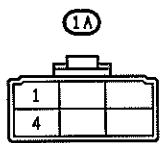

**D1** 黄色

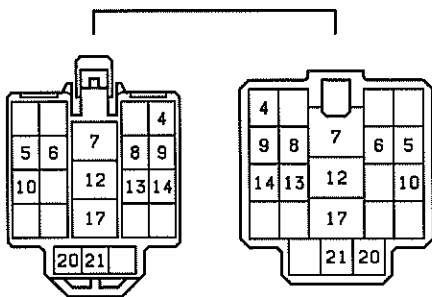

**D3** 黄色

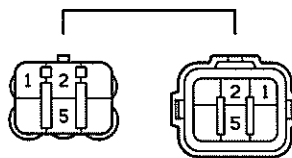

**F1** 黄色

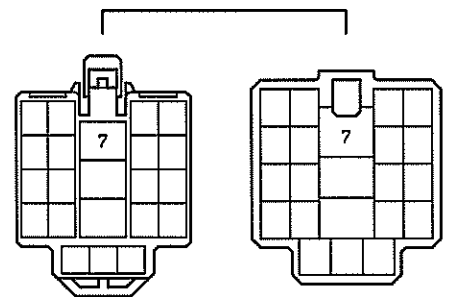

**K1**

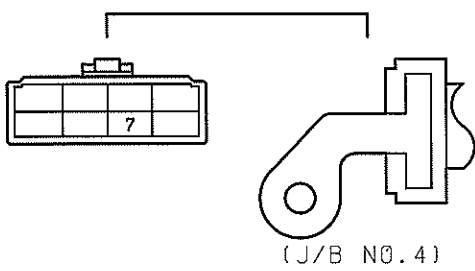

**L1** 緑色

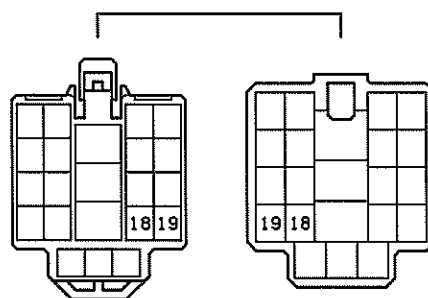

**Q1**

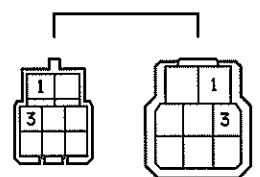

# ヘッドランプ

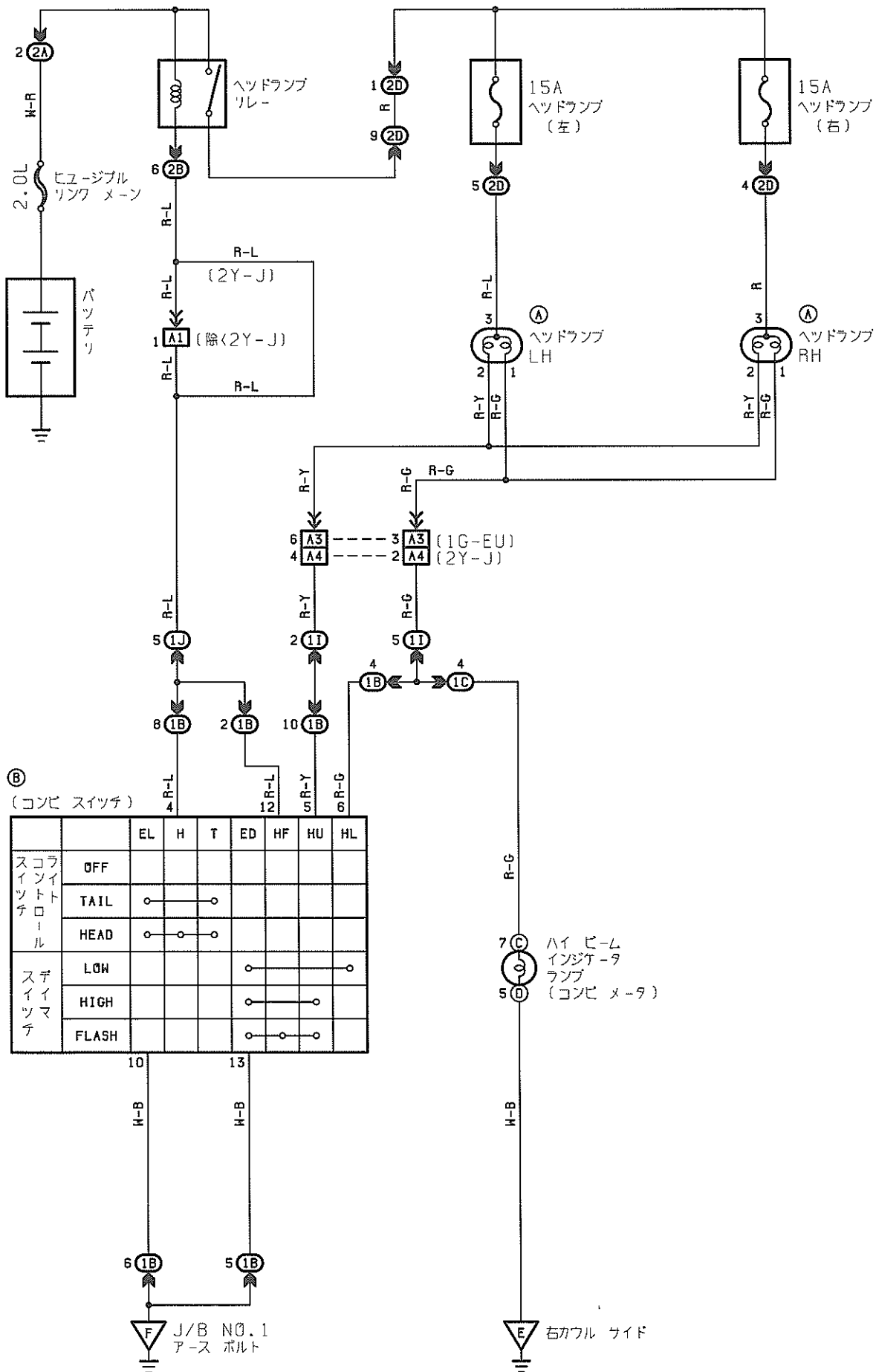

① 青色

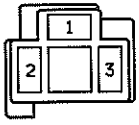

② 黒色

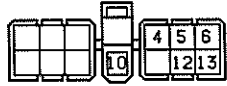

③

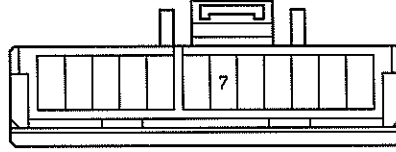

④ 茶色

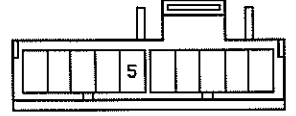

①B

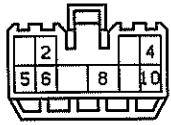

①C

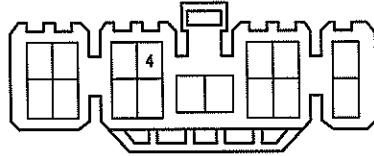

①I 黒色

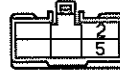

①J

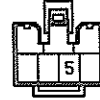

②A 黒色



②B 黒色

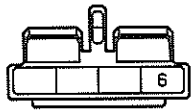

②D

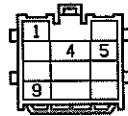

A1 青色

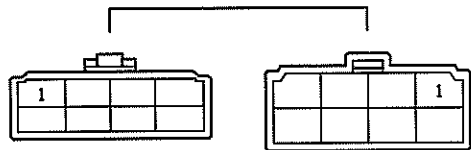

A3

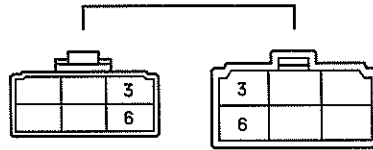

A4

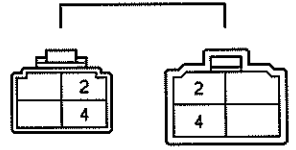



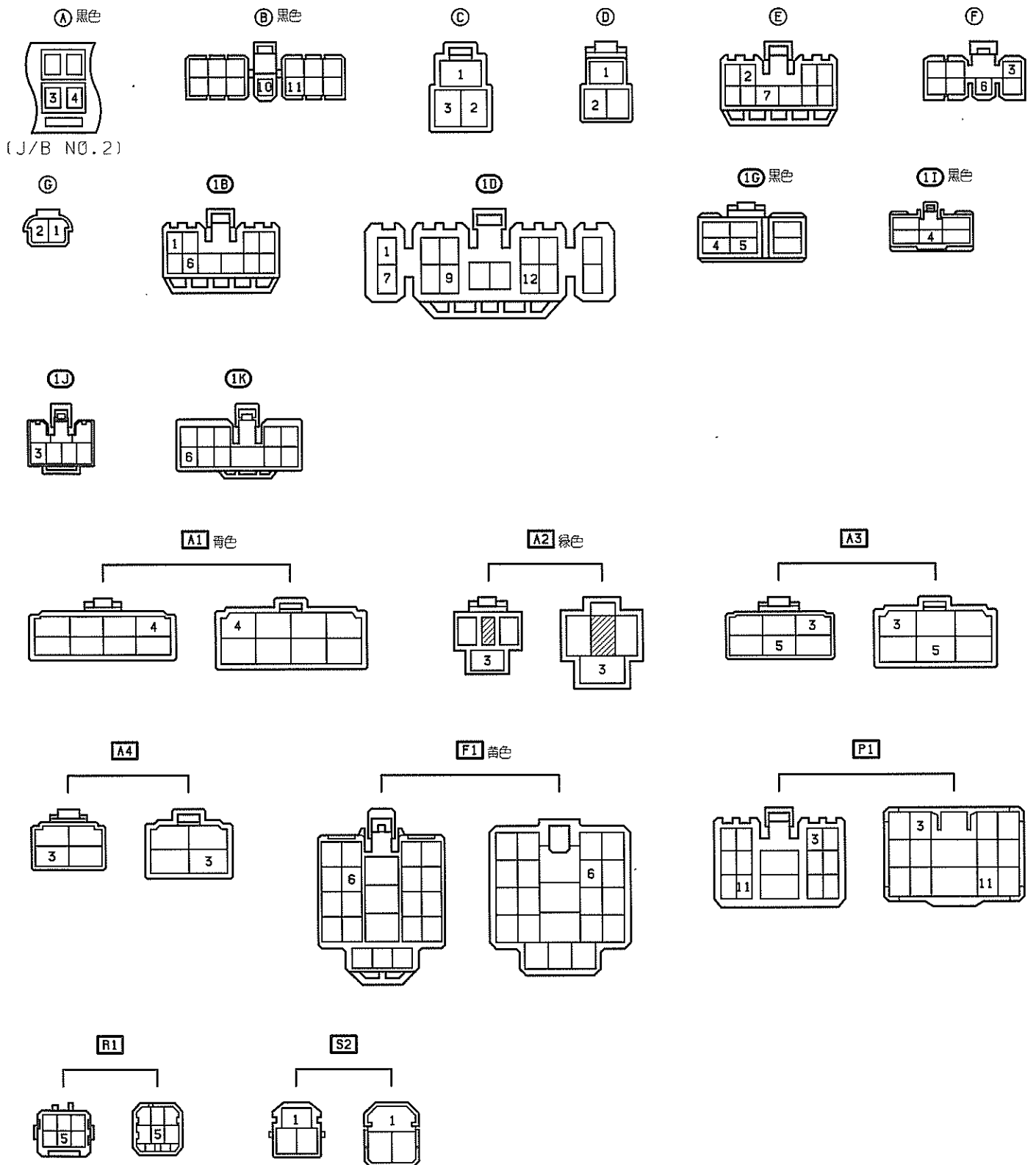



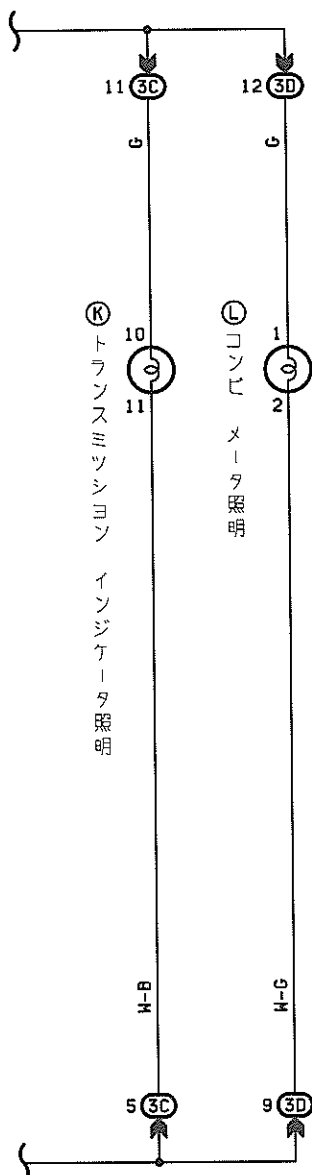
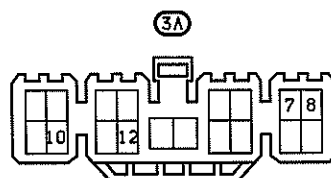
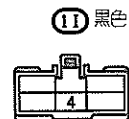
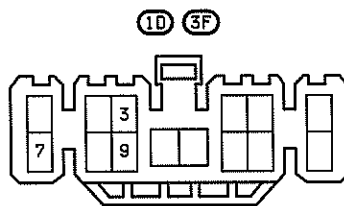
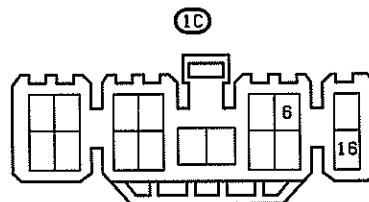
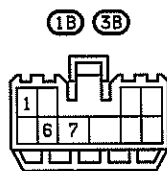
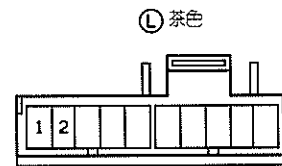
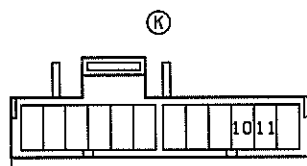
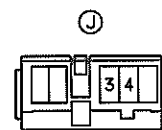
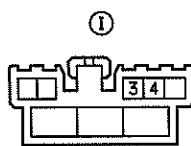
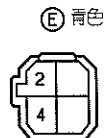
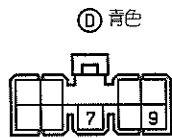
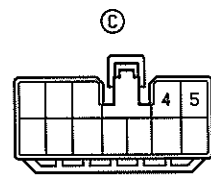
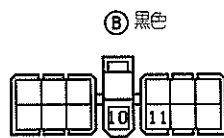
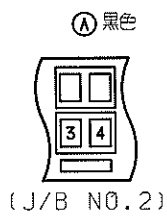



# イルミネーション

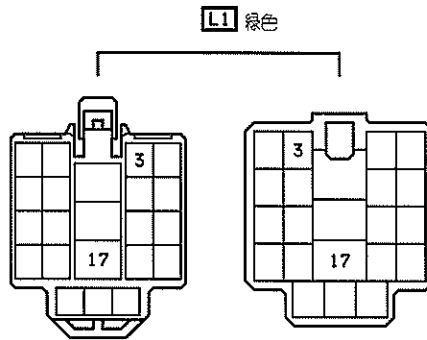
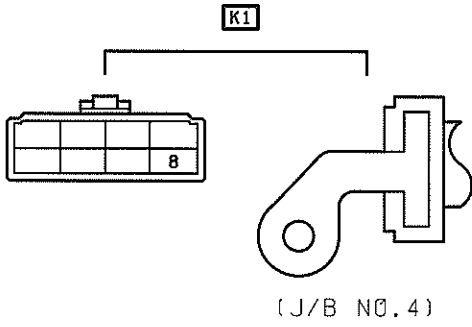
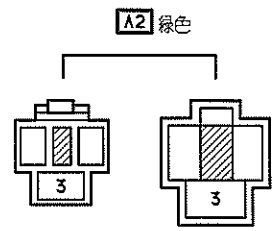
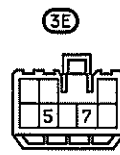
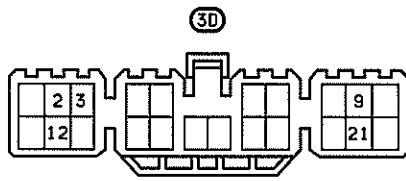
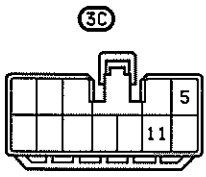

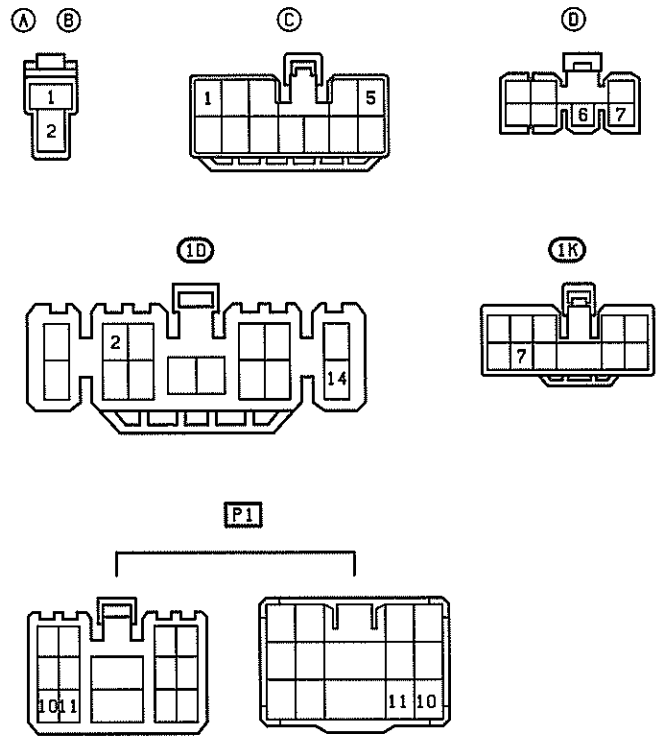
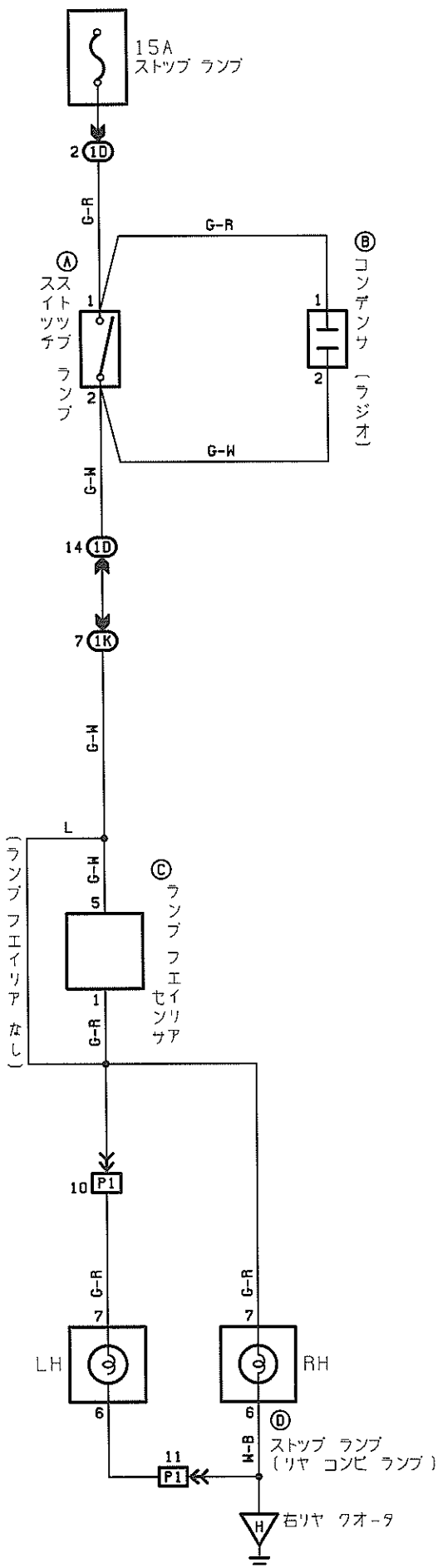



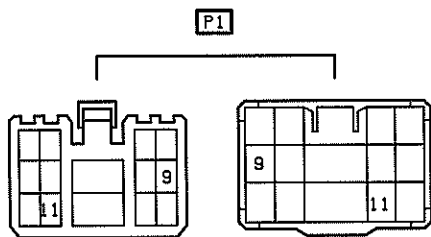
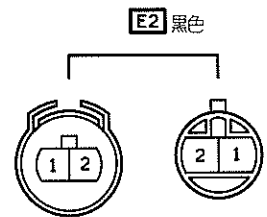
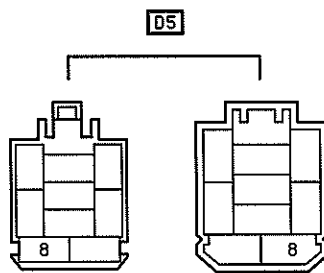
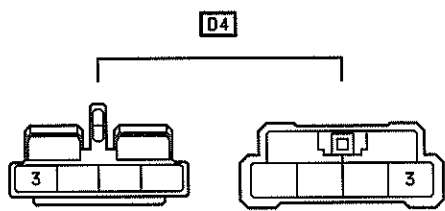
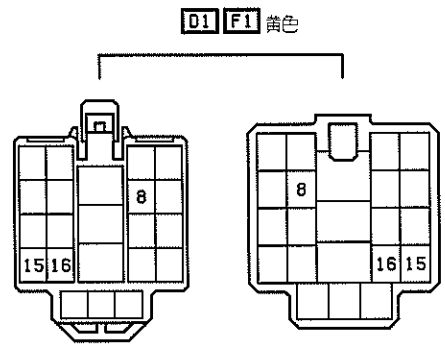
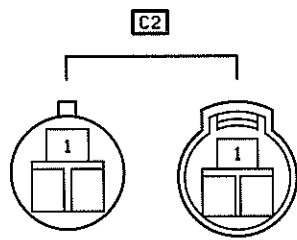
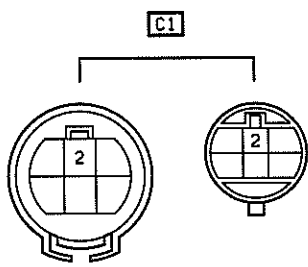



# リヤ ライト ウォーニング

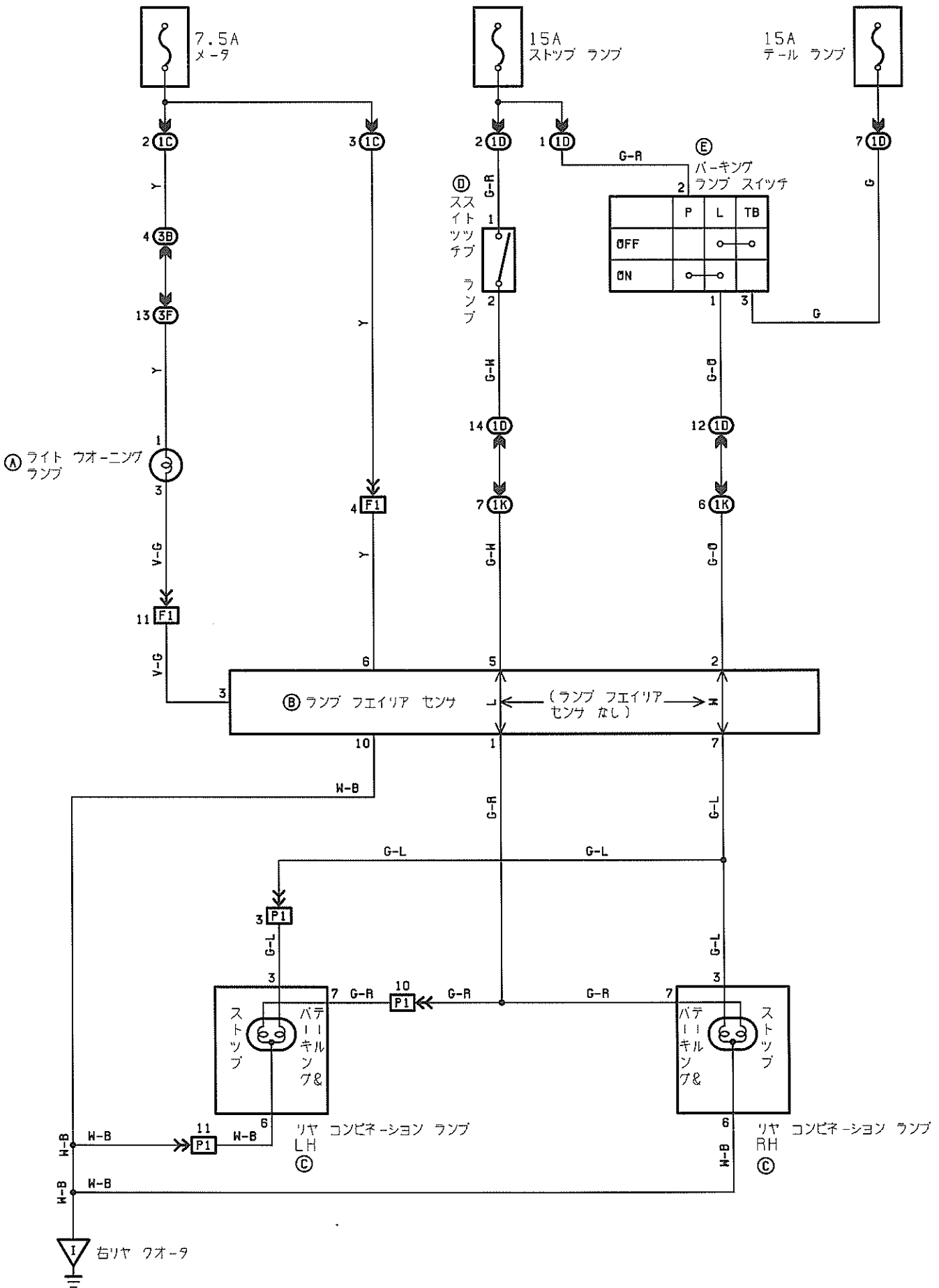

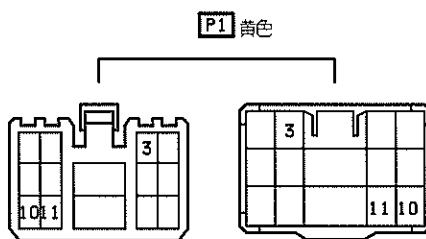
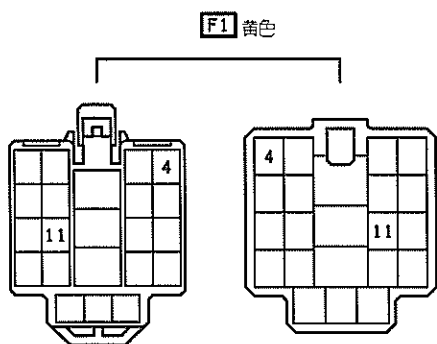
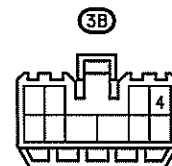
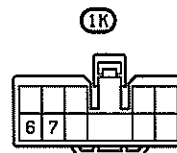
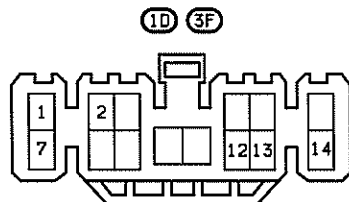
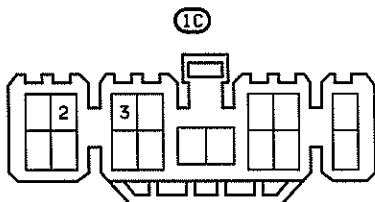
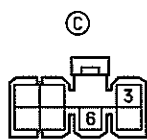
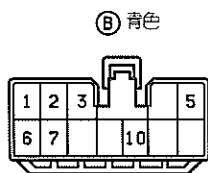
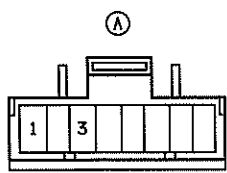



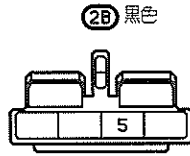
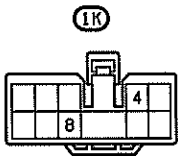
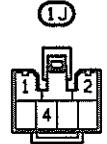
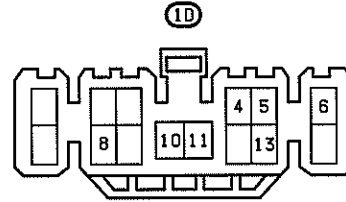
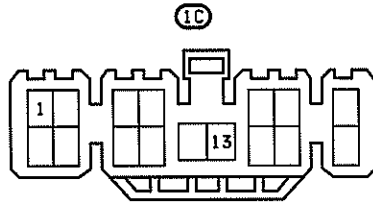
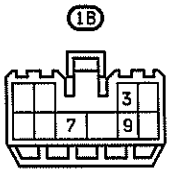
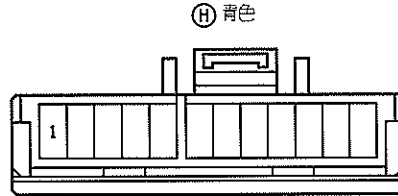
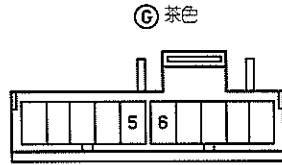
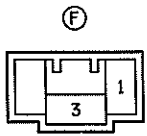
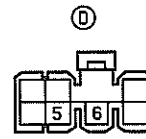
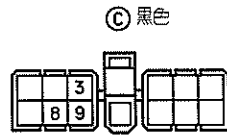
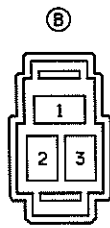
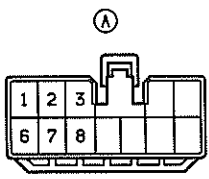

**A1 青色**

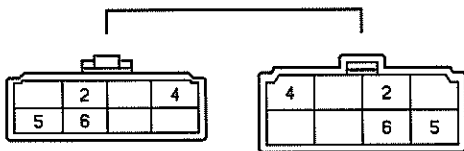

**A3**

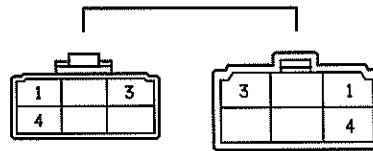

**P1 黄色**

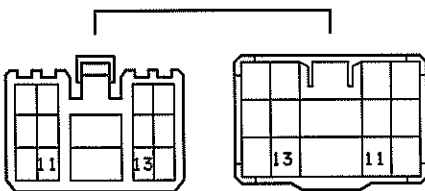

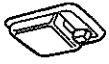

# インテリア ランプ

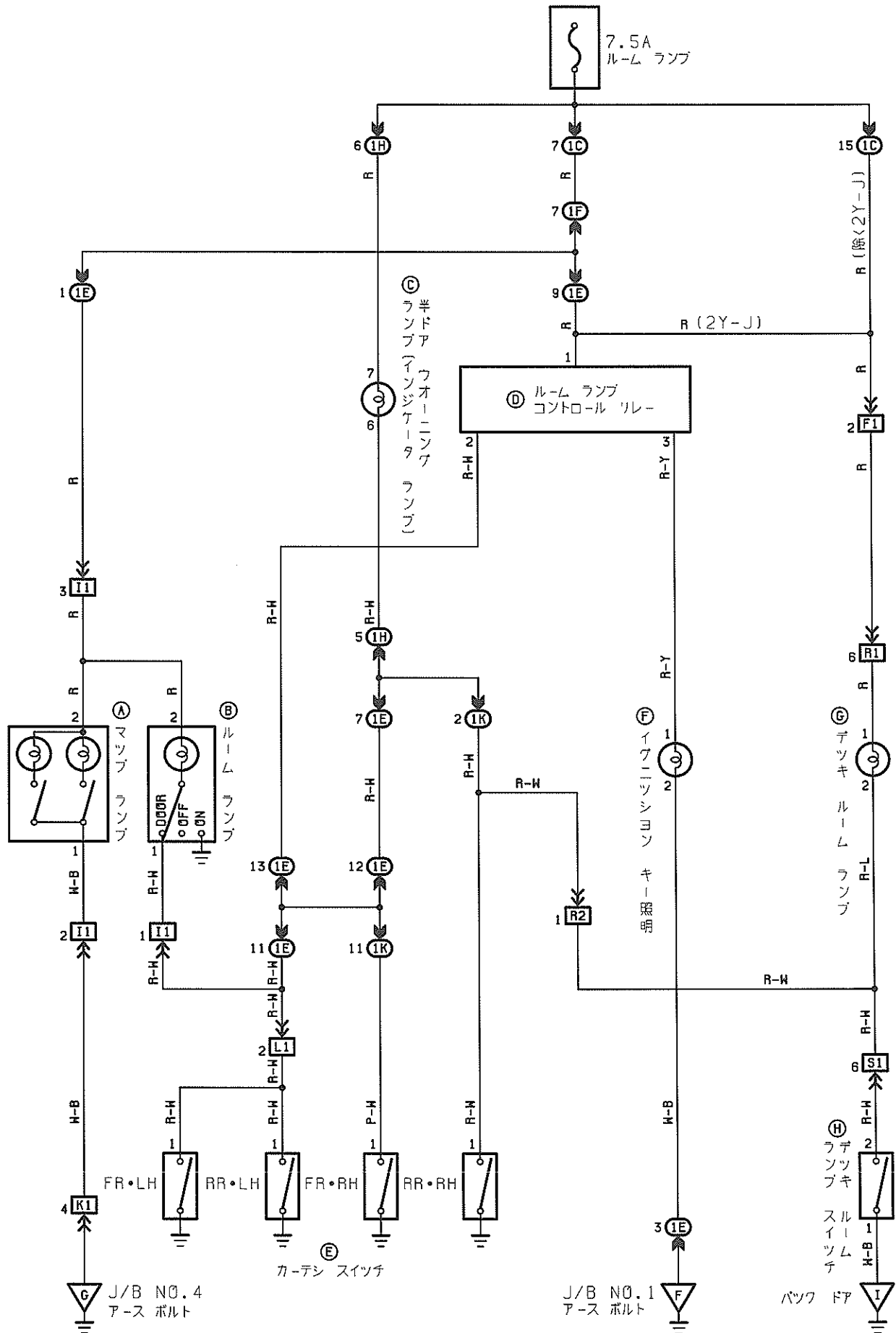

A B



C 灰色

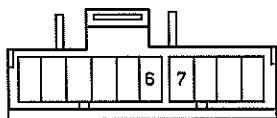

D 緑色

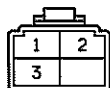

E



F だいだい色

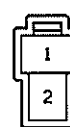

G



H



IC

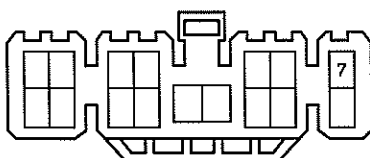

IE

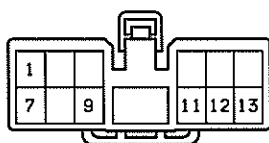

IF

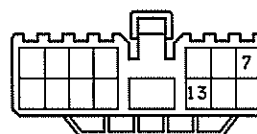

IH

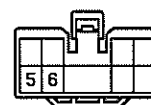

IK

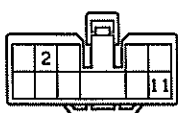

F1 黄色

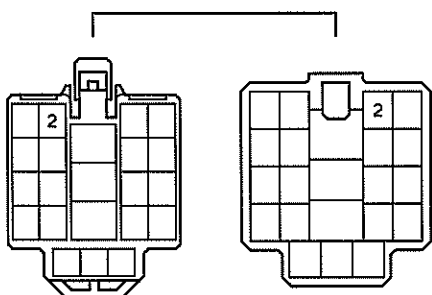

I1 だいだい色

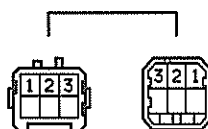

K1 緑色

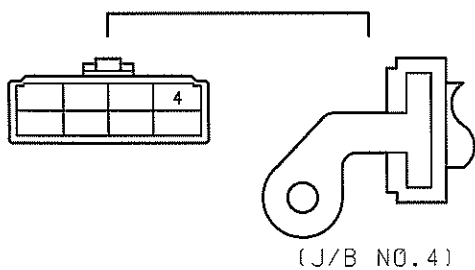

L1

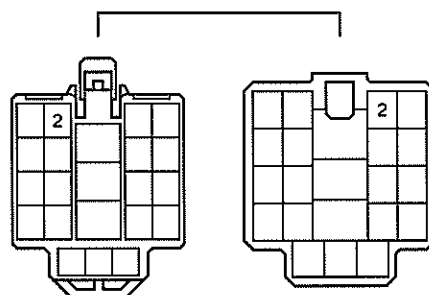

R1 S1

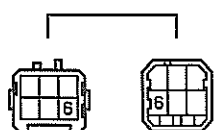

R2

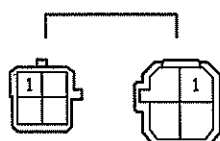



Ⓐ 黒色

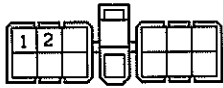

Ⓑ 黒色

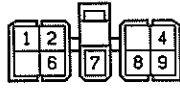

Ⓒ

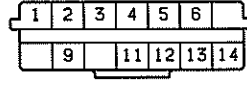

Ⓓ 青色

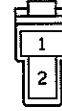

Ⓔ

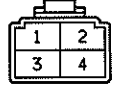

Ⓕ

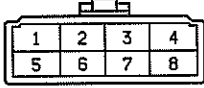

⓫

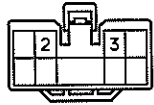



# リヤ ウインド デフォガ

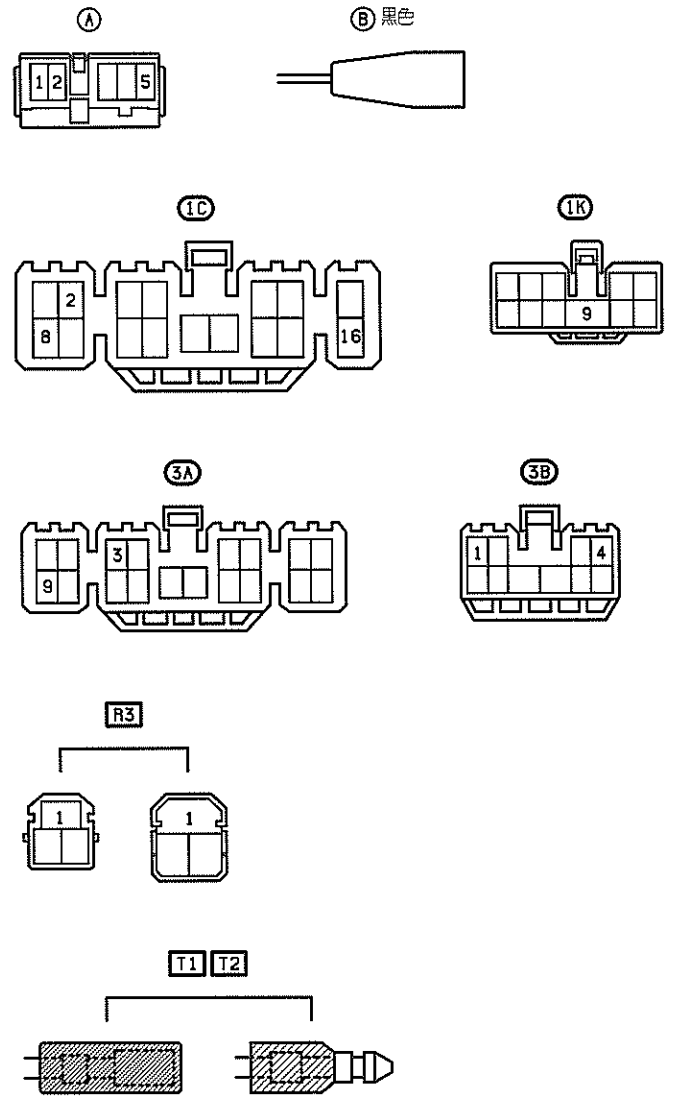
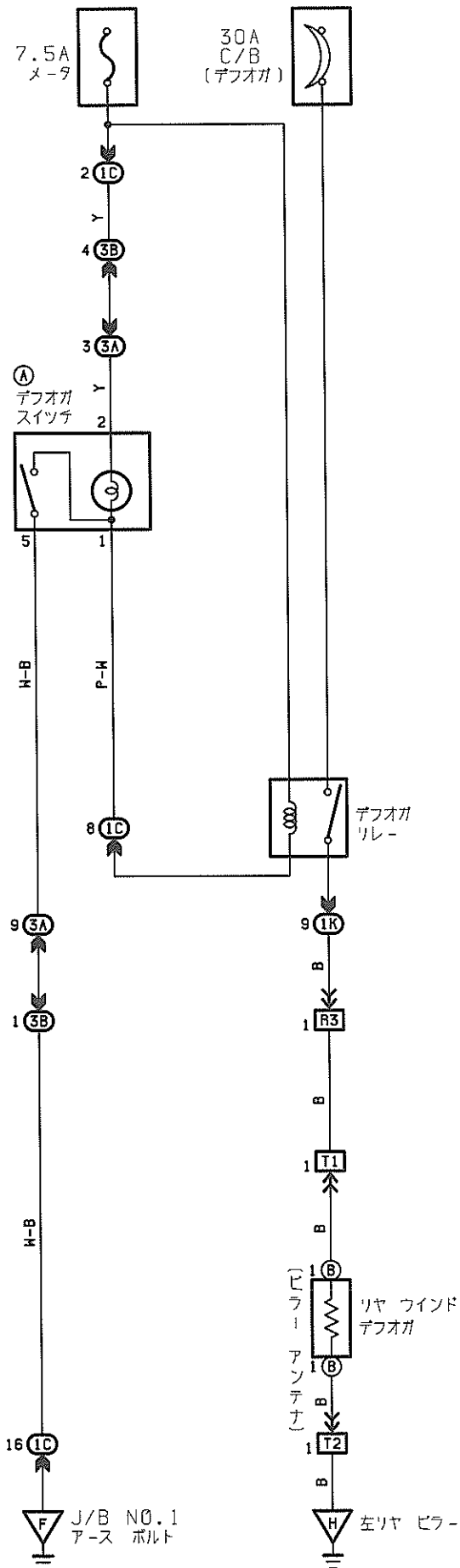



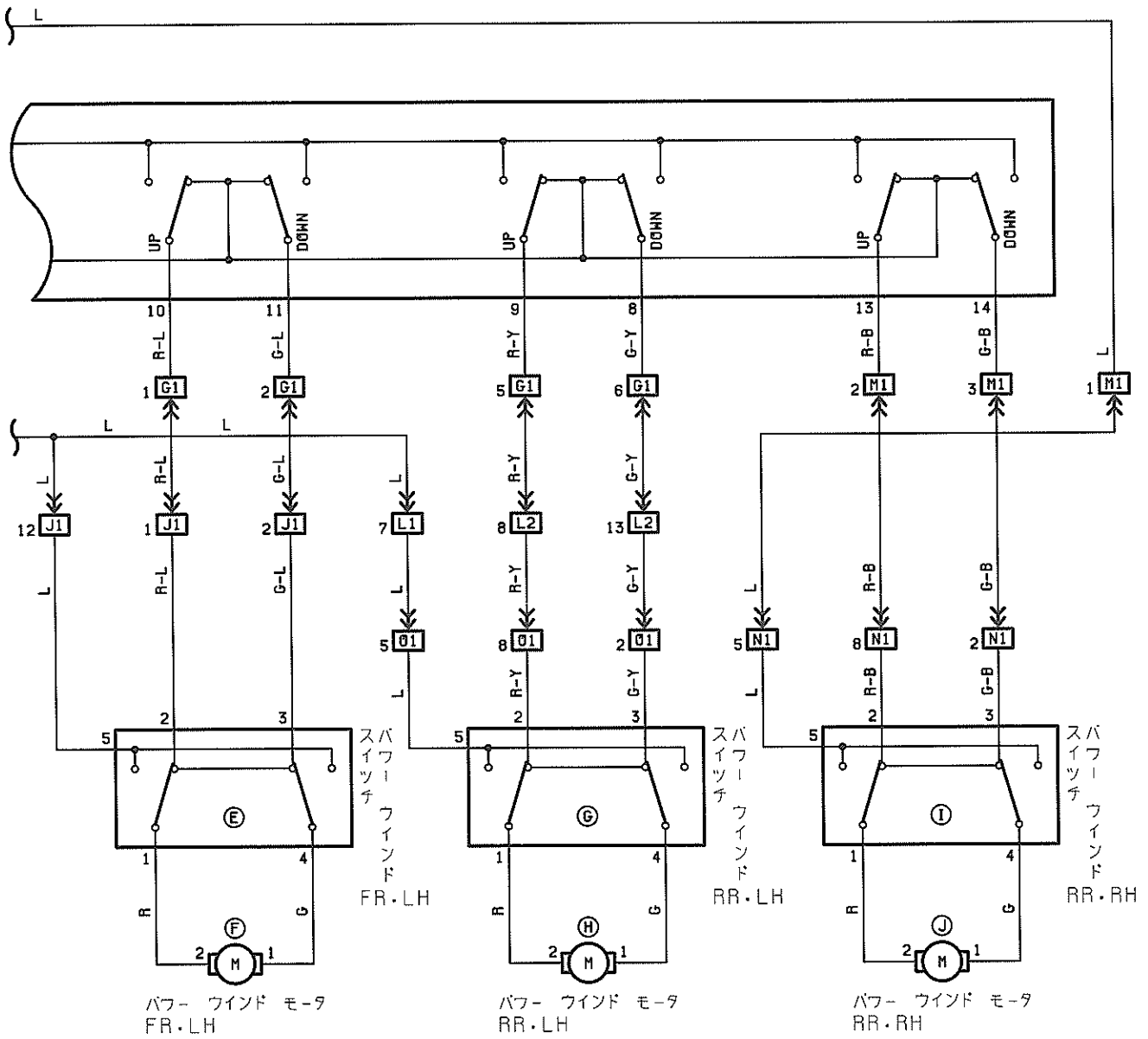



# パワー ウィンド

Ⓐ 黒色

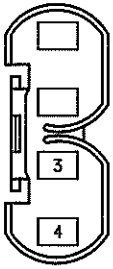

Ⓑ

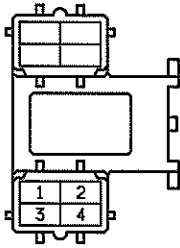

Ⓒ

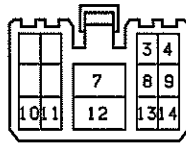

Ⓓ Ⓕ Ⓖ Ⓗ Ⓙ



Ⓔ Ⓖ Ⓙ



⓫

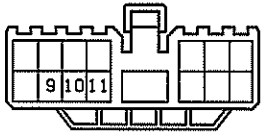

⓪ ⓫ 青色

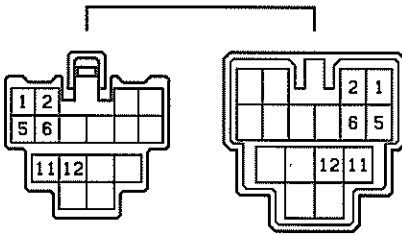

⓫ ⓫ 緑色

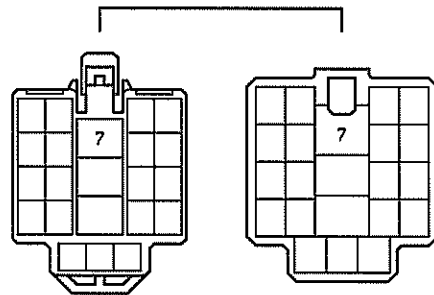

⓫

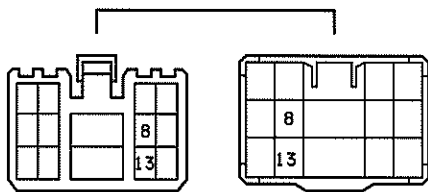

⓫

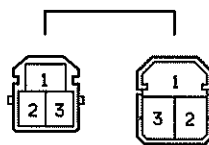

⓫ ⓫ 青色

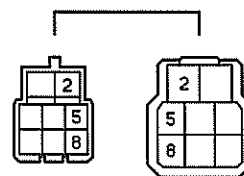





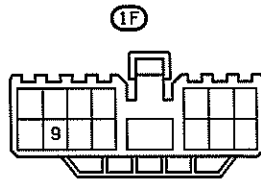
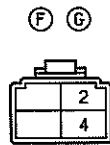
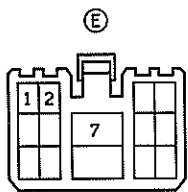
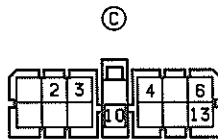
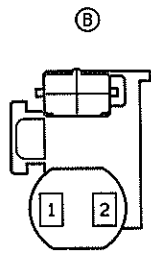
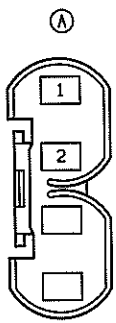

**F1** 黄色

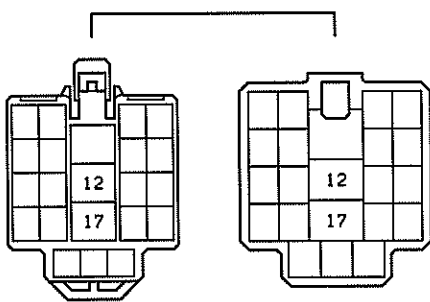

**F2**

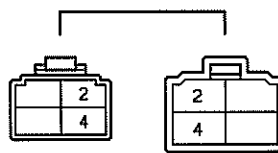

**G1 J1** 青色

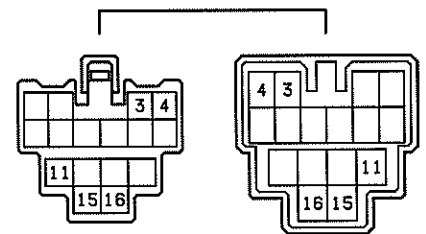

**K1**

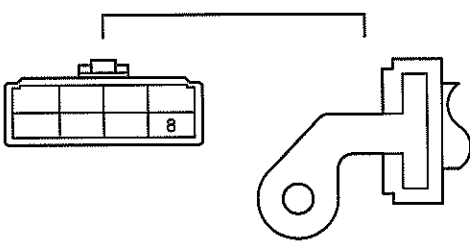

**L1** 緑色

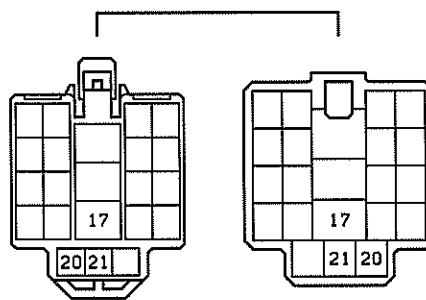

**L2**

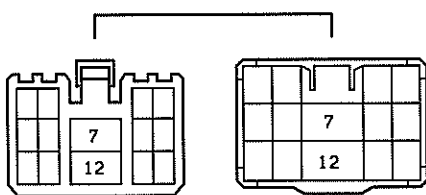

**N1 O1** 青色

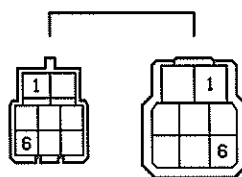

**R3 S2**

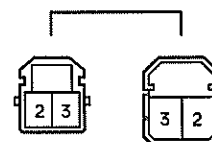



# オーバードライブ

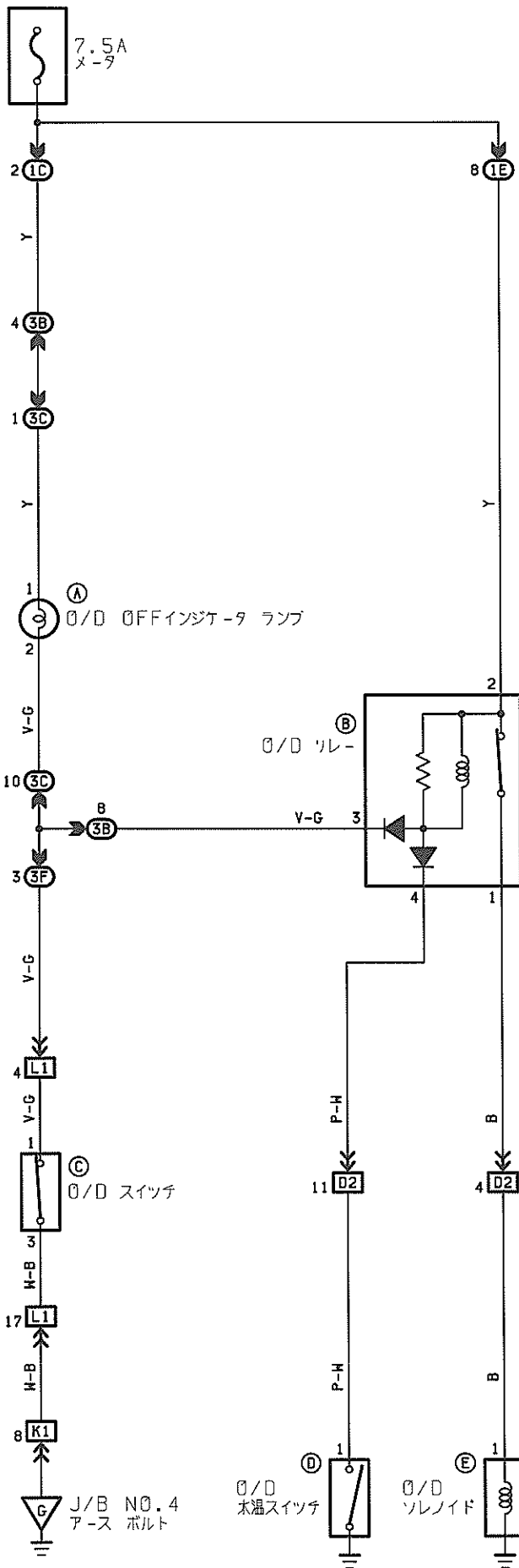

◎ O/D スイッチ  
 1-3: 導通あり(O/D OFF時)  
 : 導通なし(O/D ON, O/D OFFインジケータ消灯)

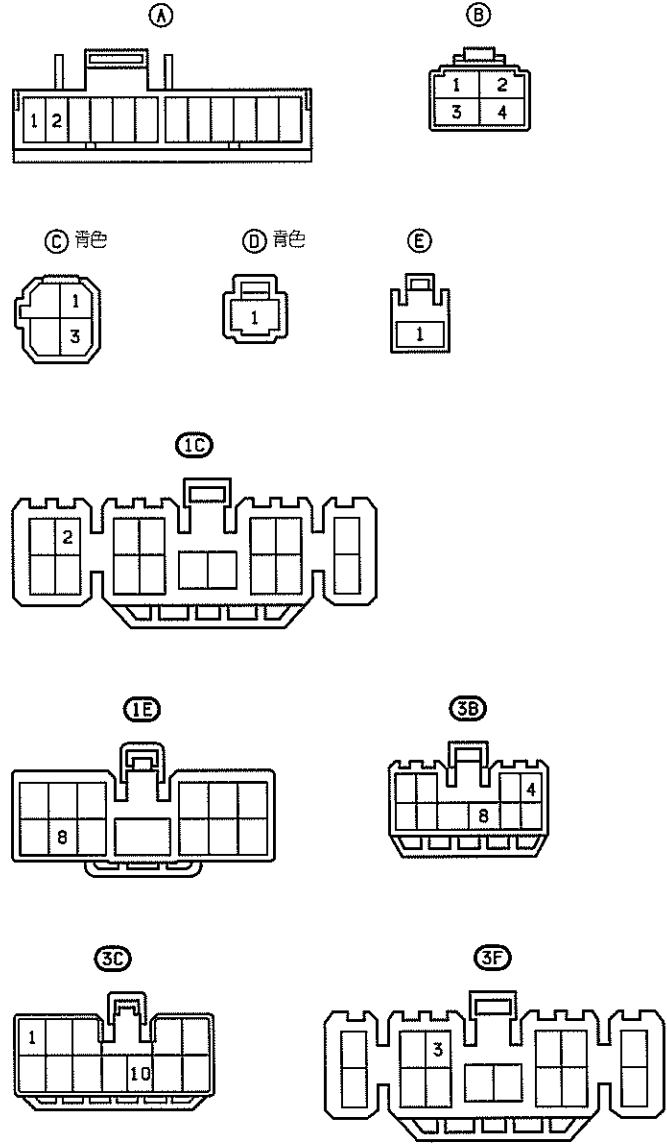

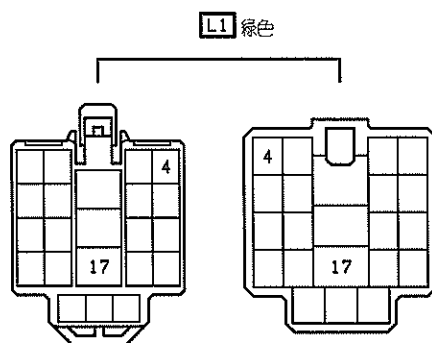
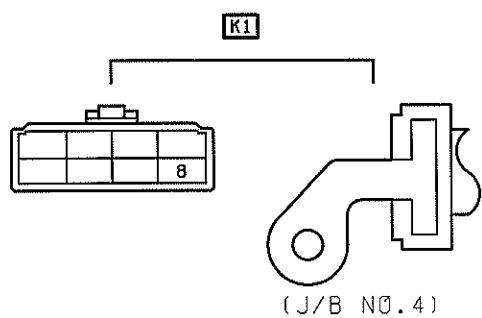
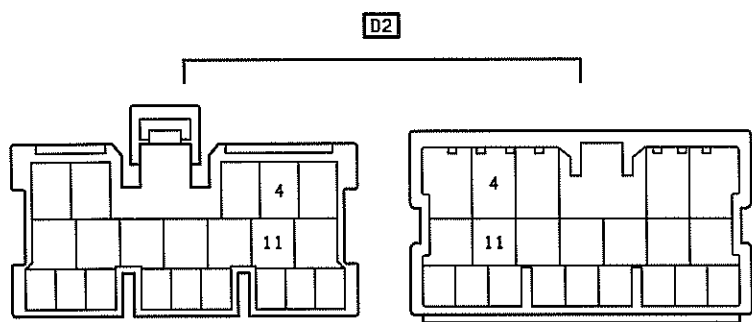



# トランスミッション インジケータ

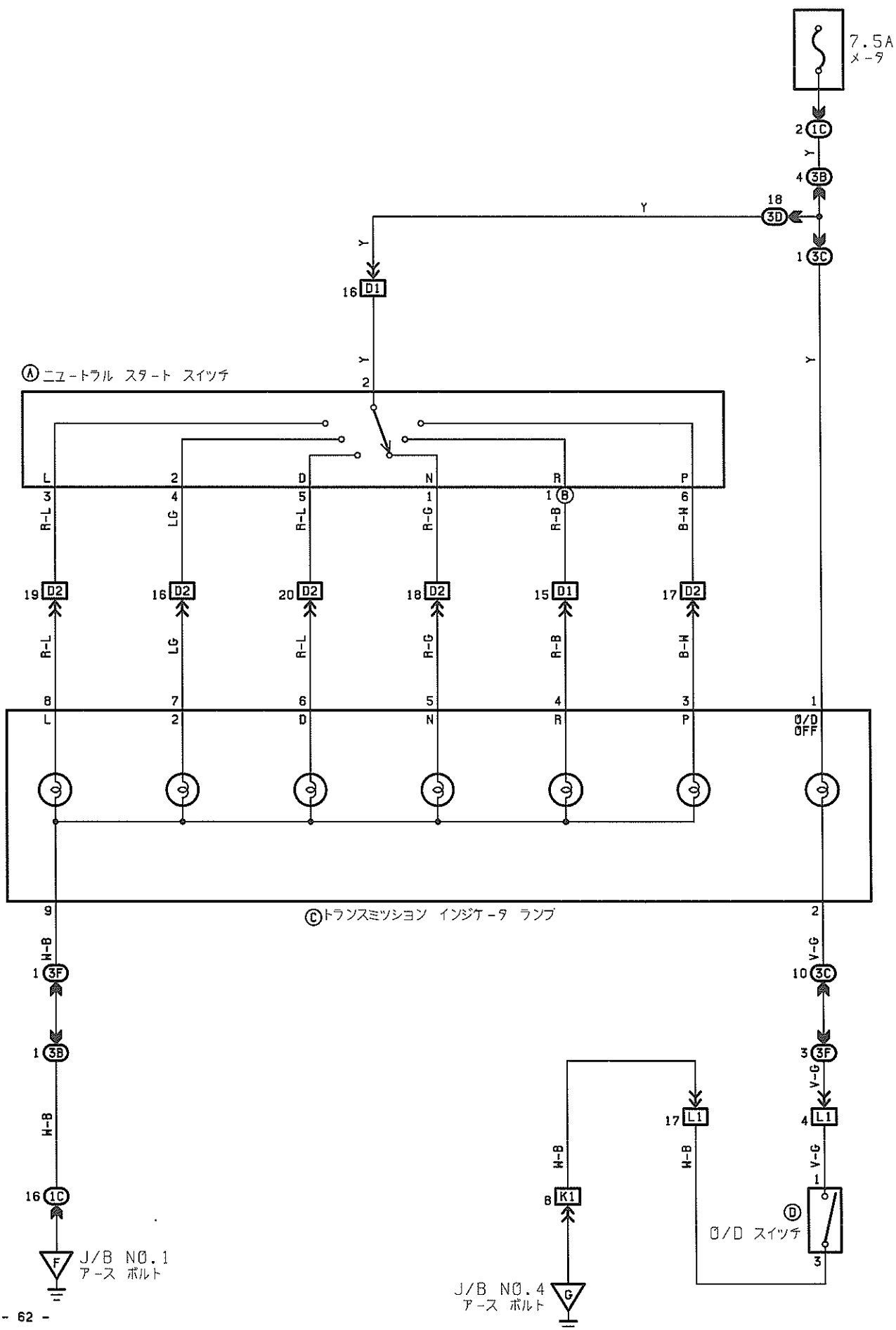

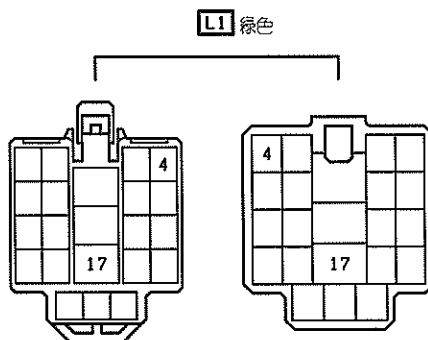
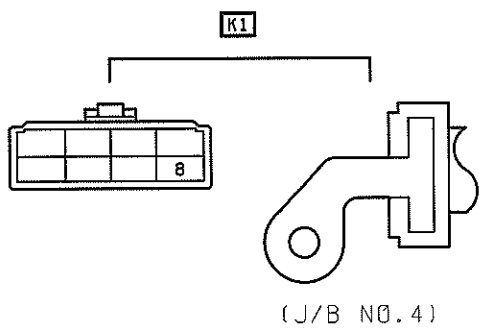
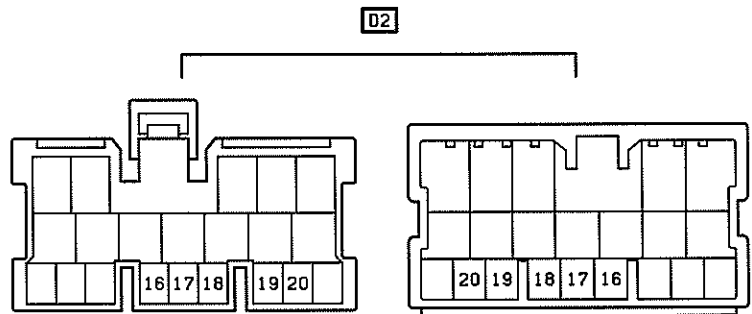
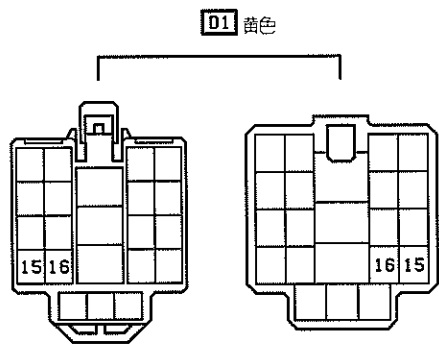
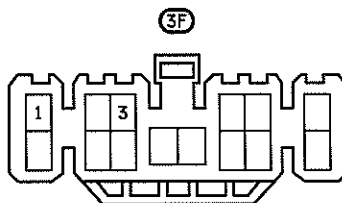
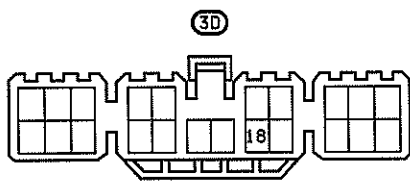
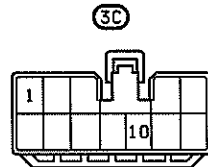
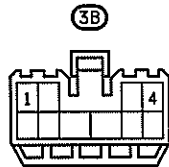
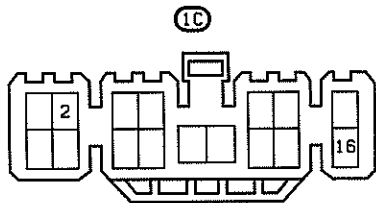
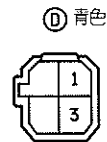
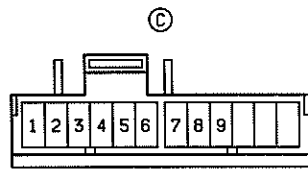
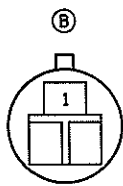
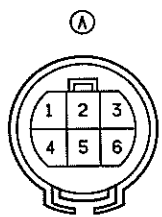

ホーン、シガレットライター & フロツク

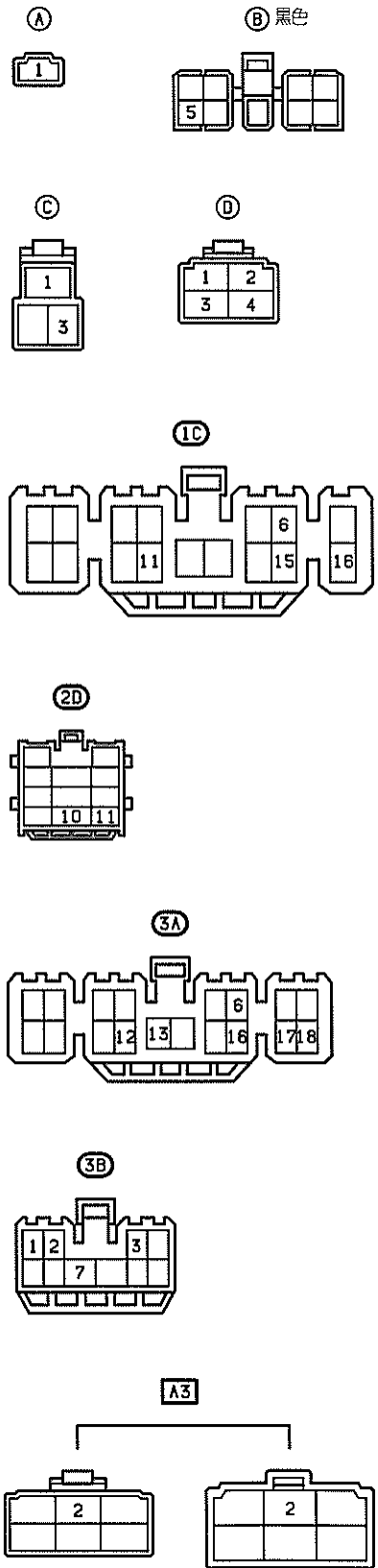
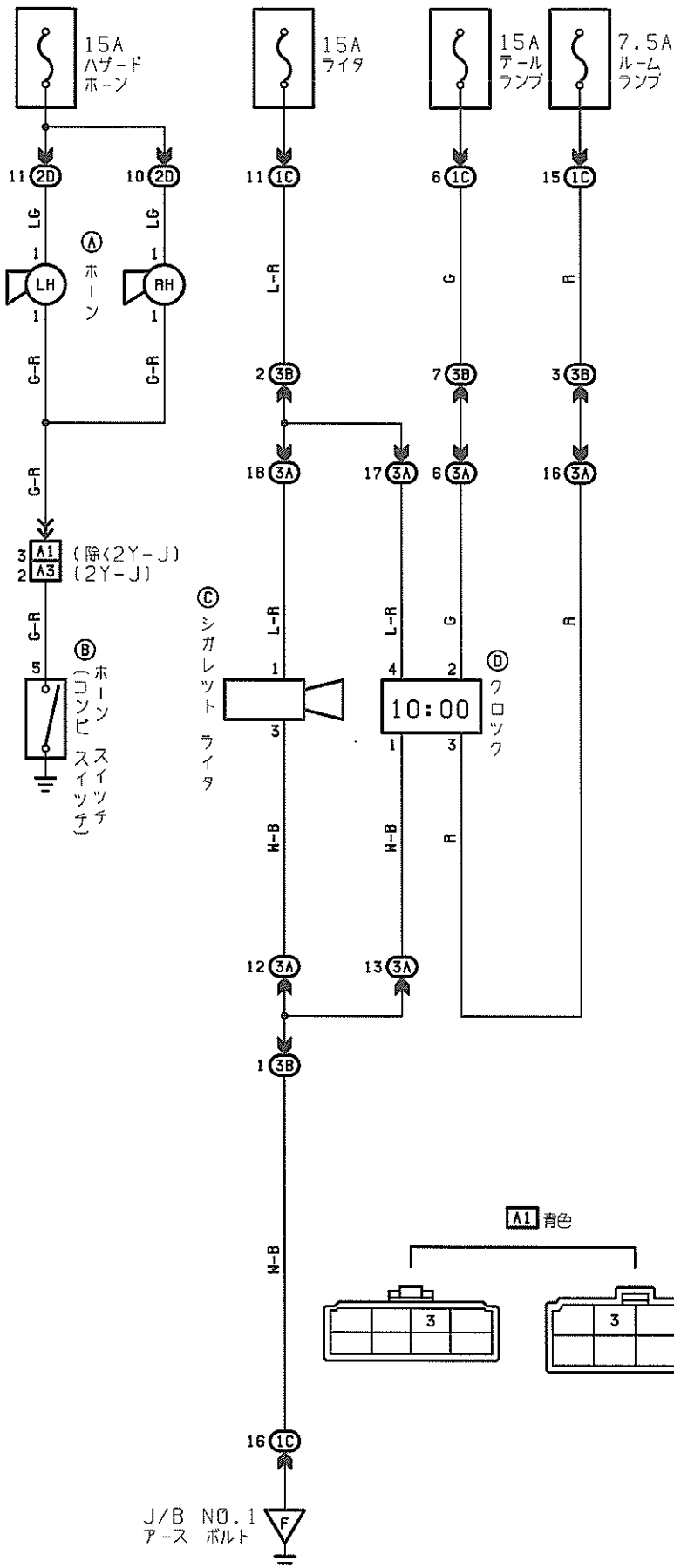

# ラジオ & ステレオ(2スピーカー)

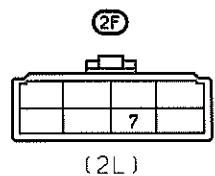
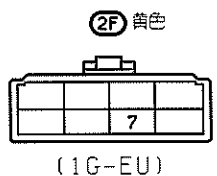
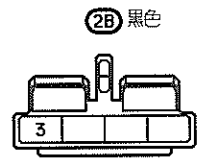
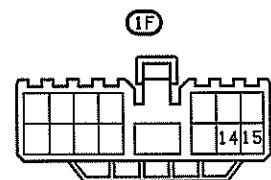
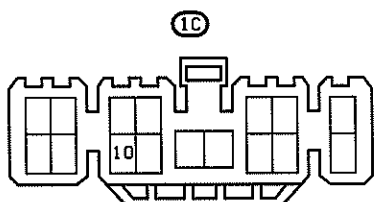
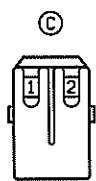
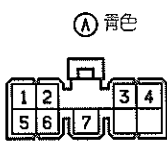
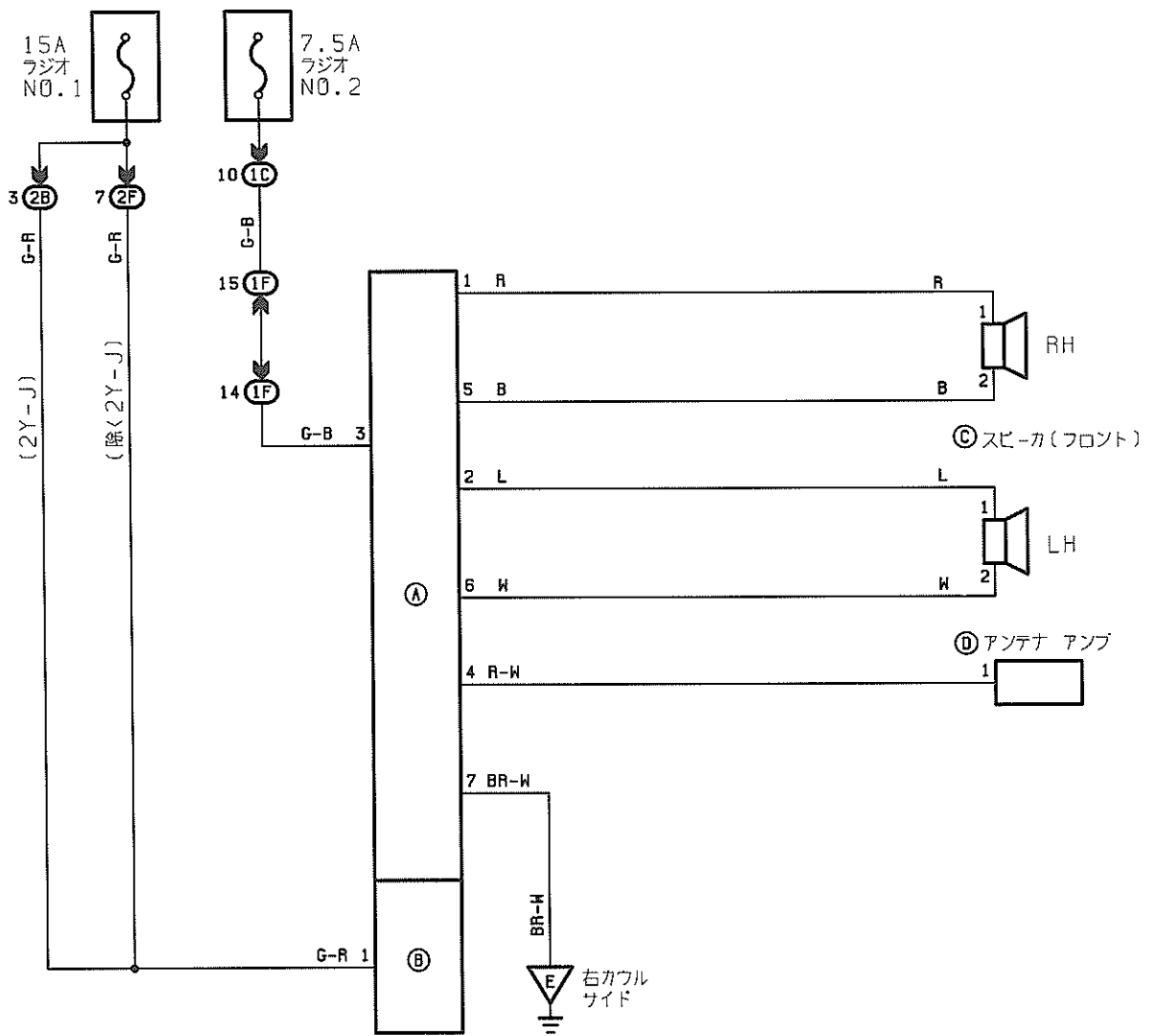



# モータ アンテナ

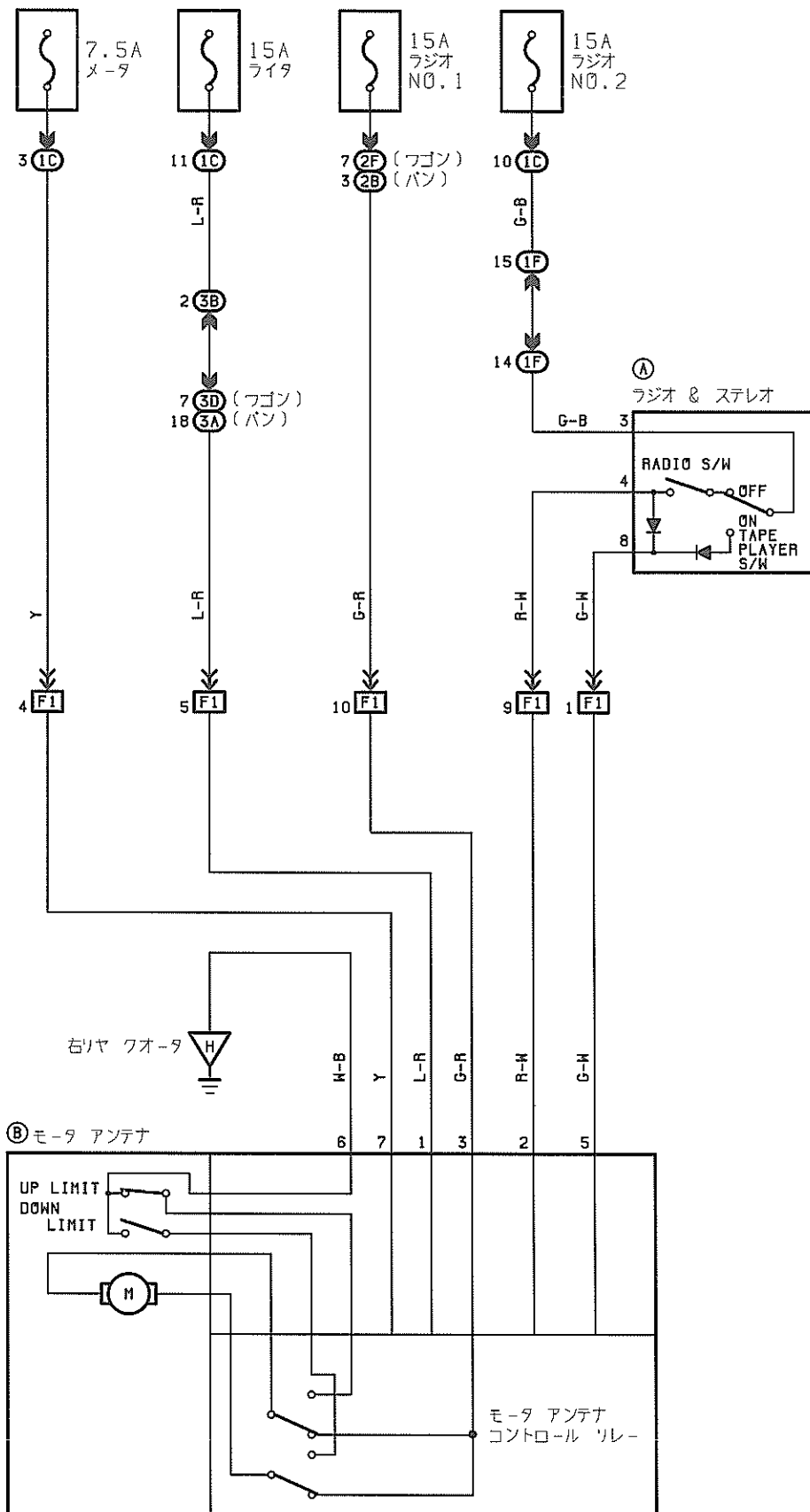

## ⑧ モーター アンテナ

< コネクタを切り離し、車両側コネクタ点検 >

- ① - ボデー アース : 12V (IGスイッチ "ACC")
- ② - ボデー アース : 12V (IGスイッチ "ACC", ラジオ スイッチON)
- ③ - ボデー アース : 12V (常時)
- ⑤ - ボデー アース : 12V (IGスイッチ "ACC", ラジオ スイッチON)
- ⑦ - ボデー アース : 12V (IGスイッチON)

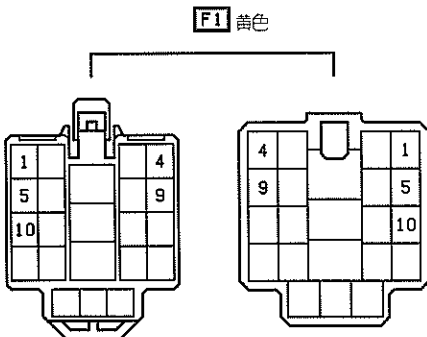
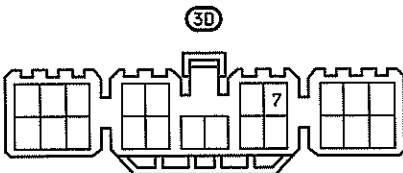
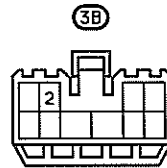
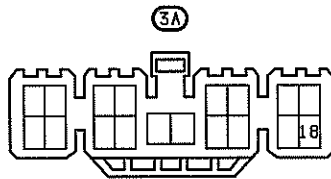
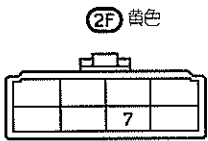
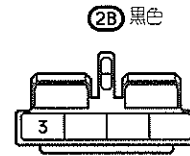
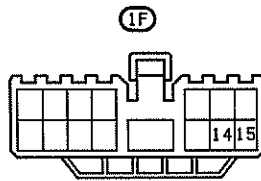
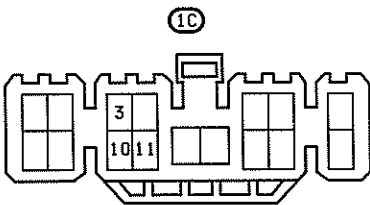
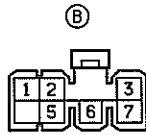
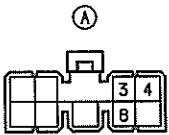

# コンビネーションメータ

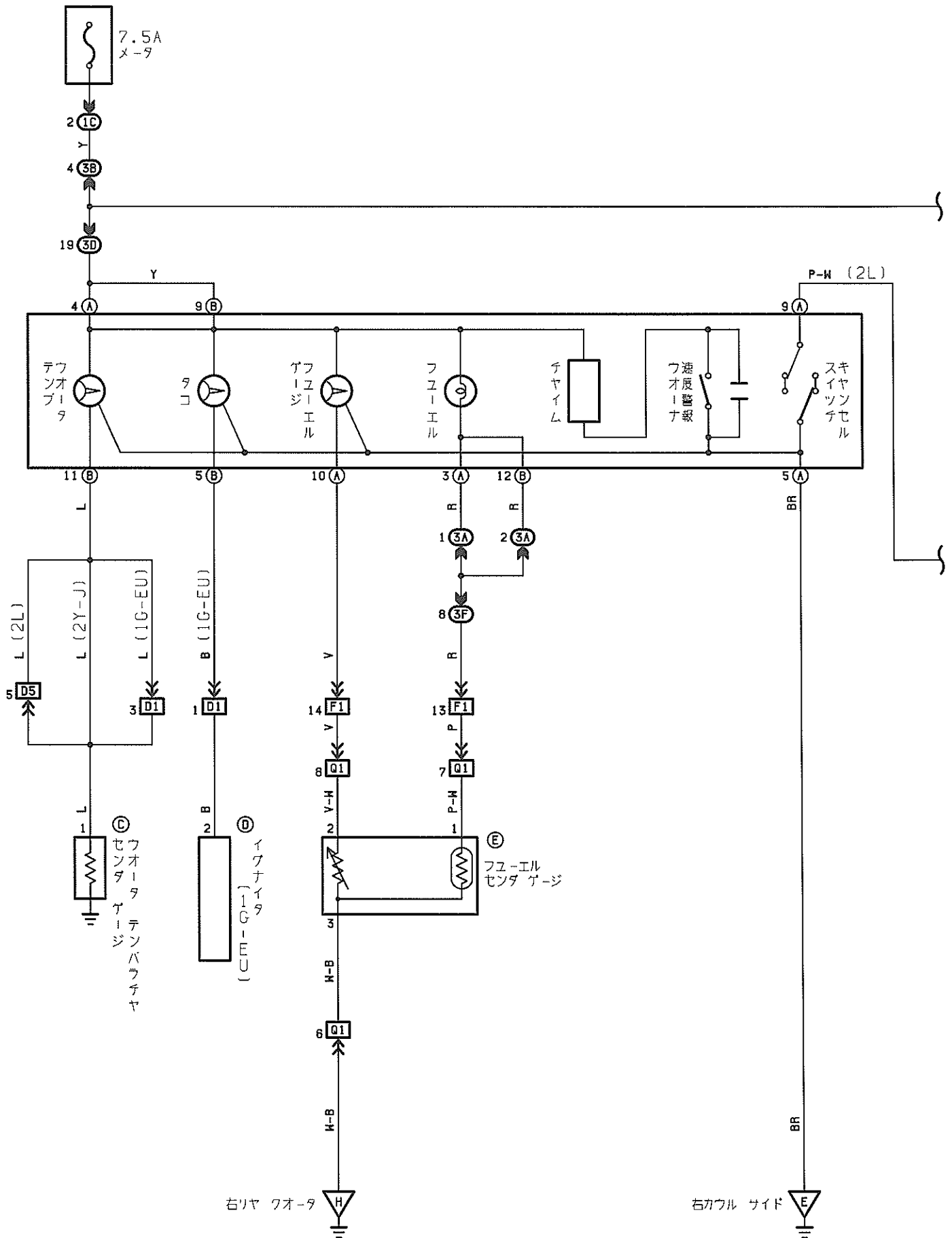



# コンビネーションメータ

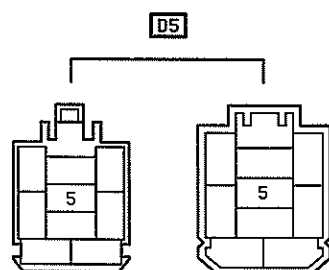
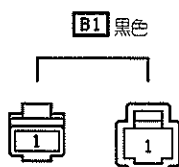
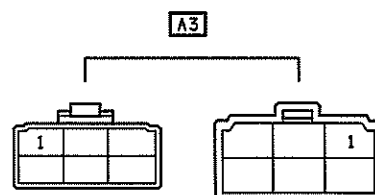
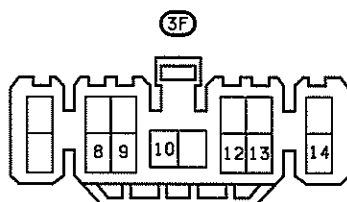
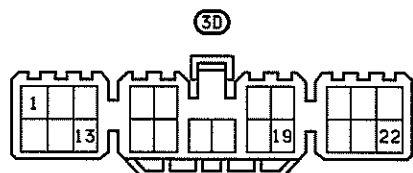
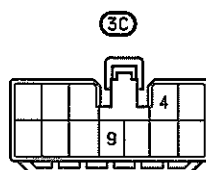
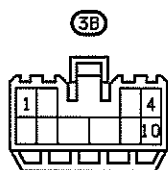
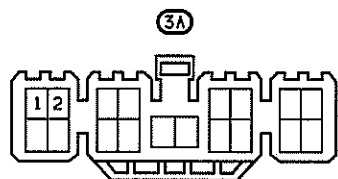
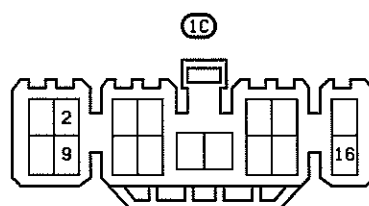
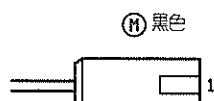
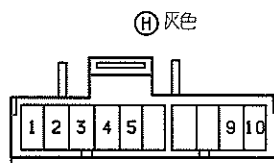
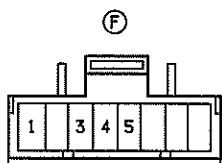
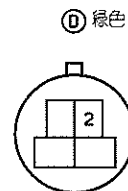
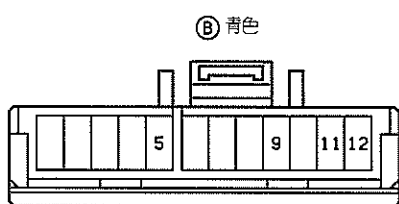
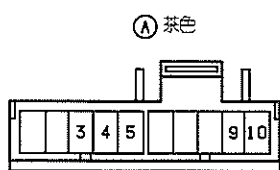

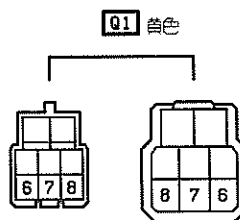
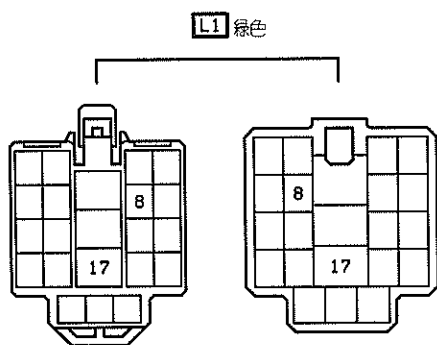
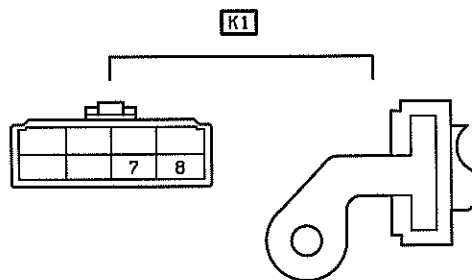
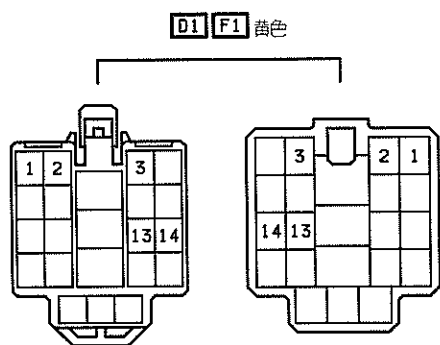



Ⓐ 黒色



(J/B NO.2)

Ⓑ 黒色

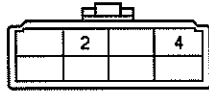

Ⓒ



Ⓓ



Ⓔ



Ⓕ

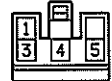

ⓐ 黒色

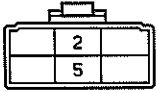

ⓐ

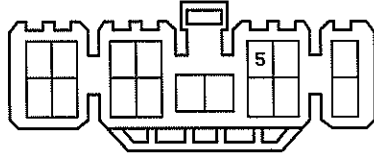

ⓑ 黒色

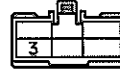

Ⓐ 黒色



Ⓑ 黒色

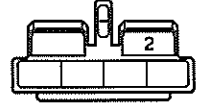

Ⓒ

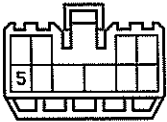

Ⓒ

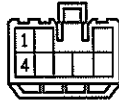

Ⓐ 緑色

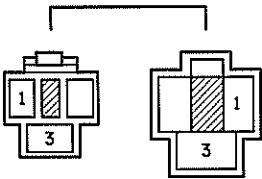

Ⓐ

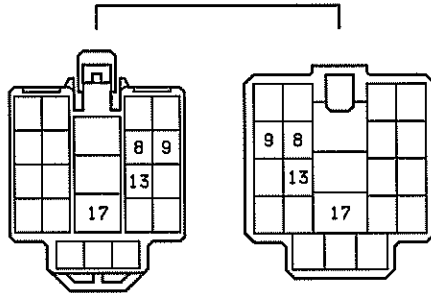

Ⓐ

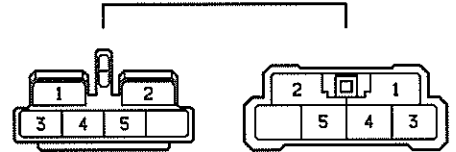

Ⓐ

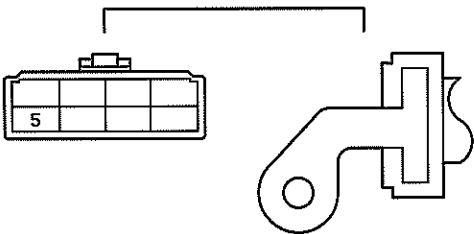

(J/B NO.4)

# オート エア コンデショナ(レバー式)

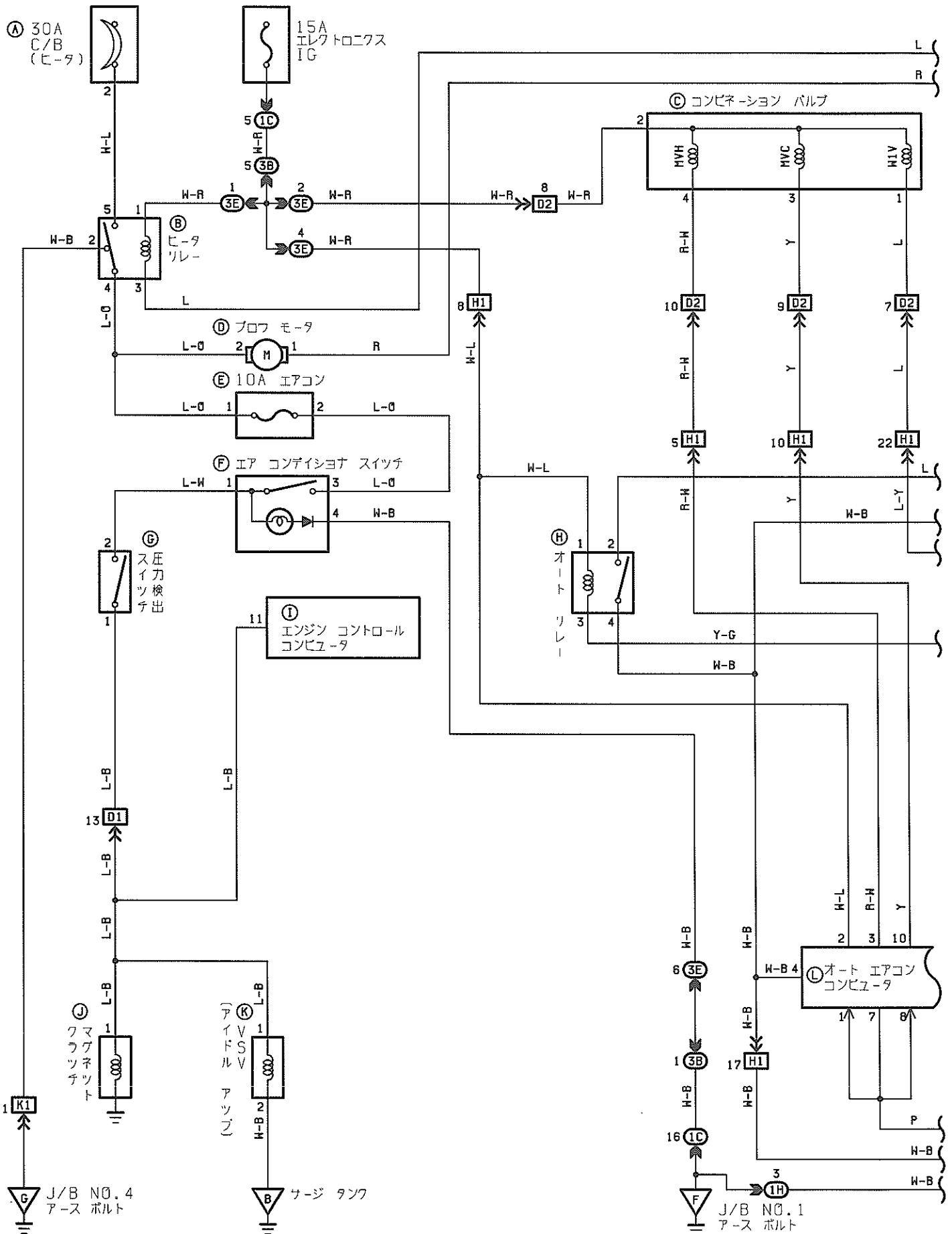



# オート エア コンデショナ(レバー式)

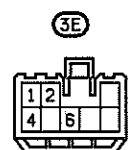
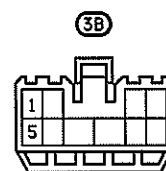
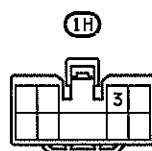
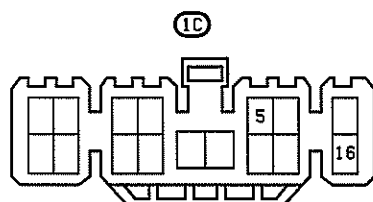
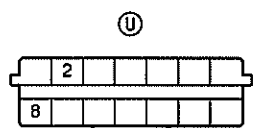
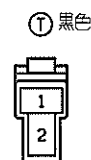
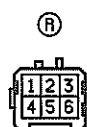
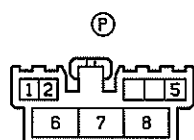
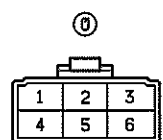
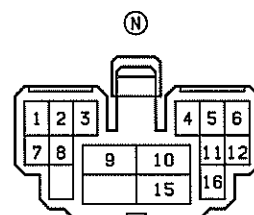
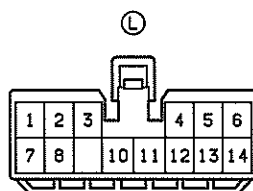
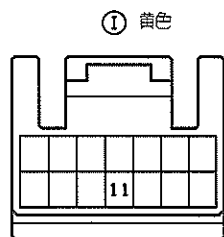
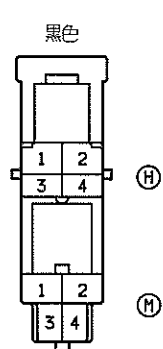
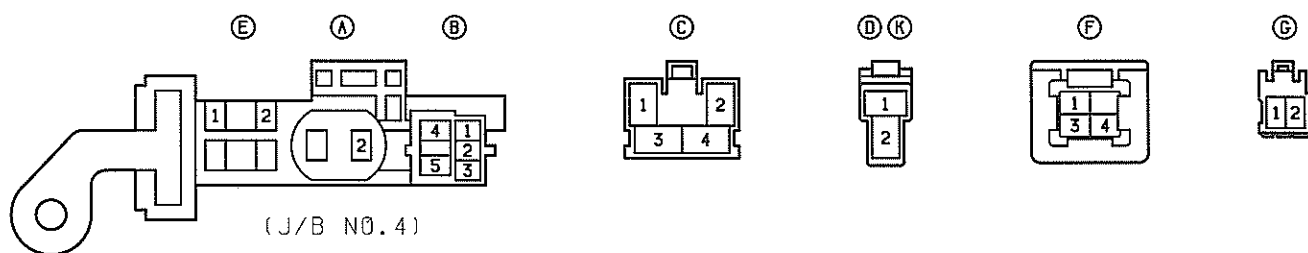

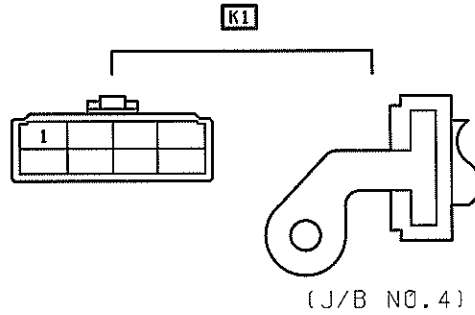
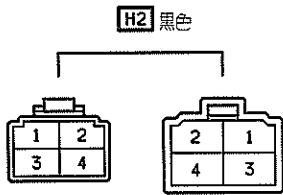
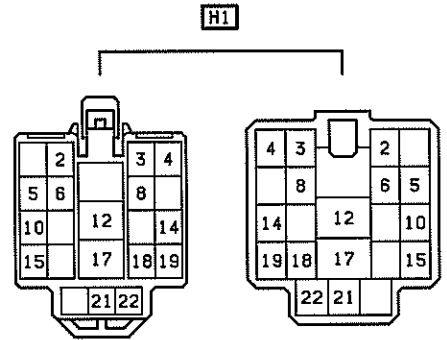
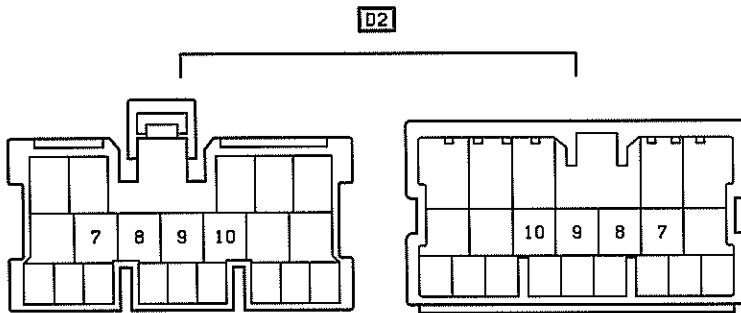
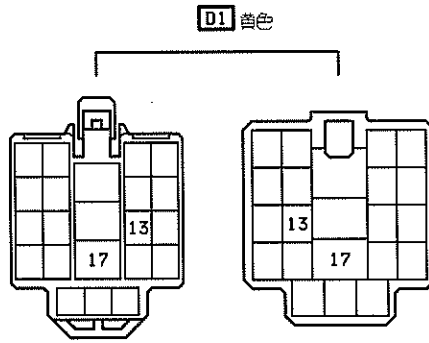
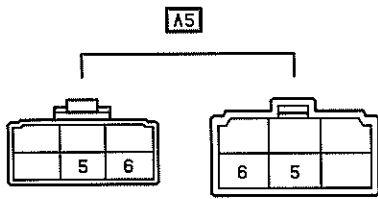



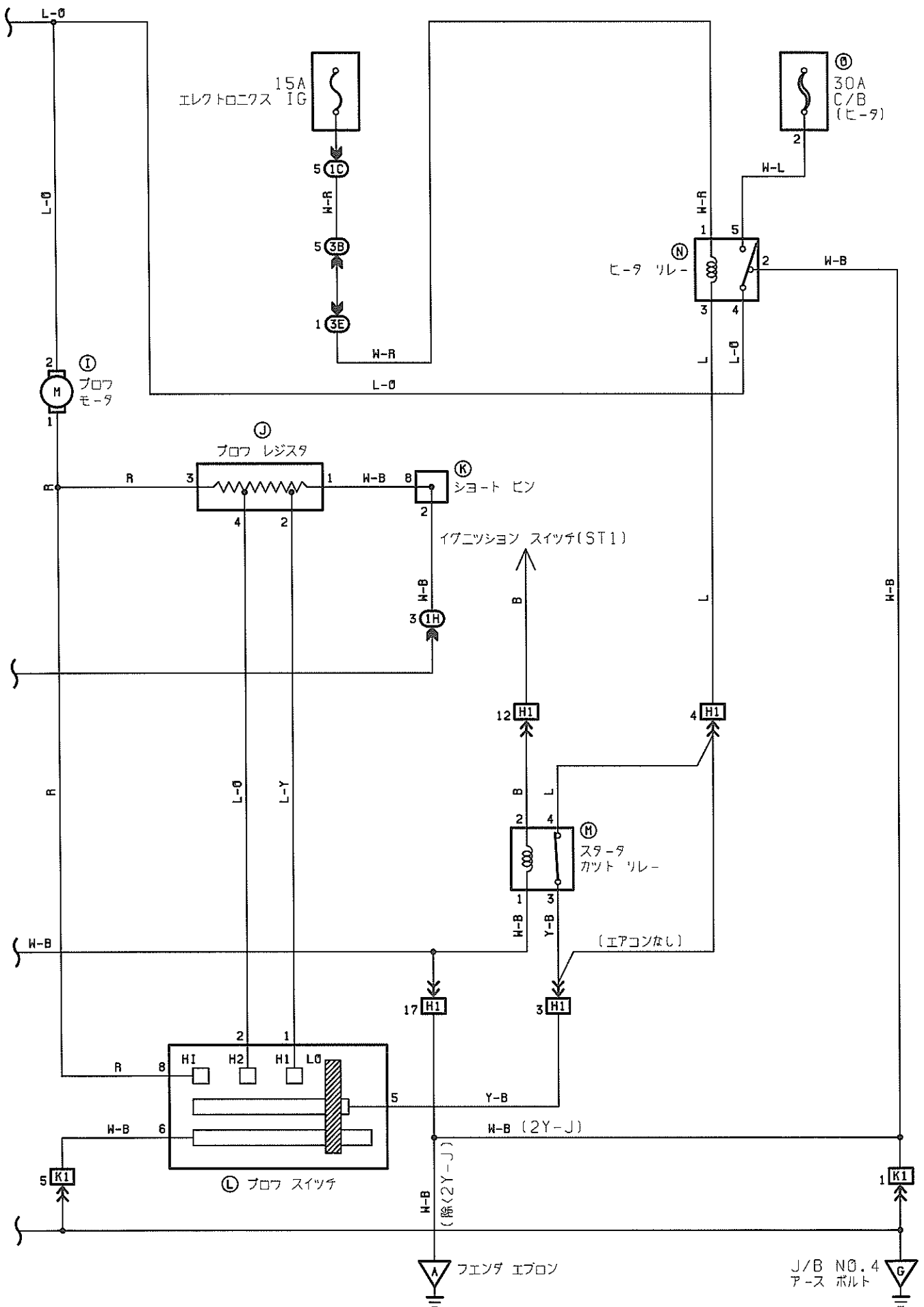

マニュアル エア コンデিশヨナ

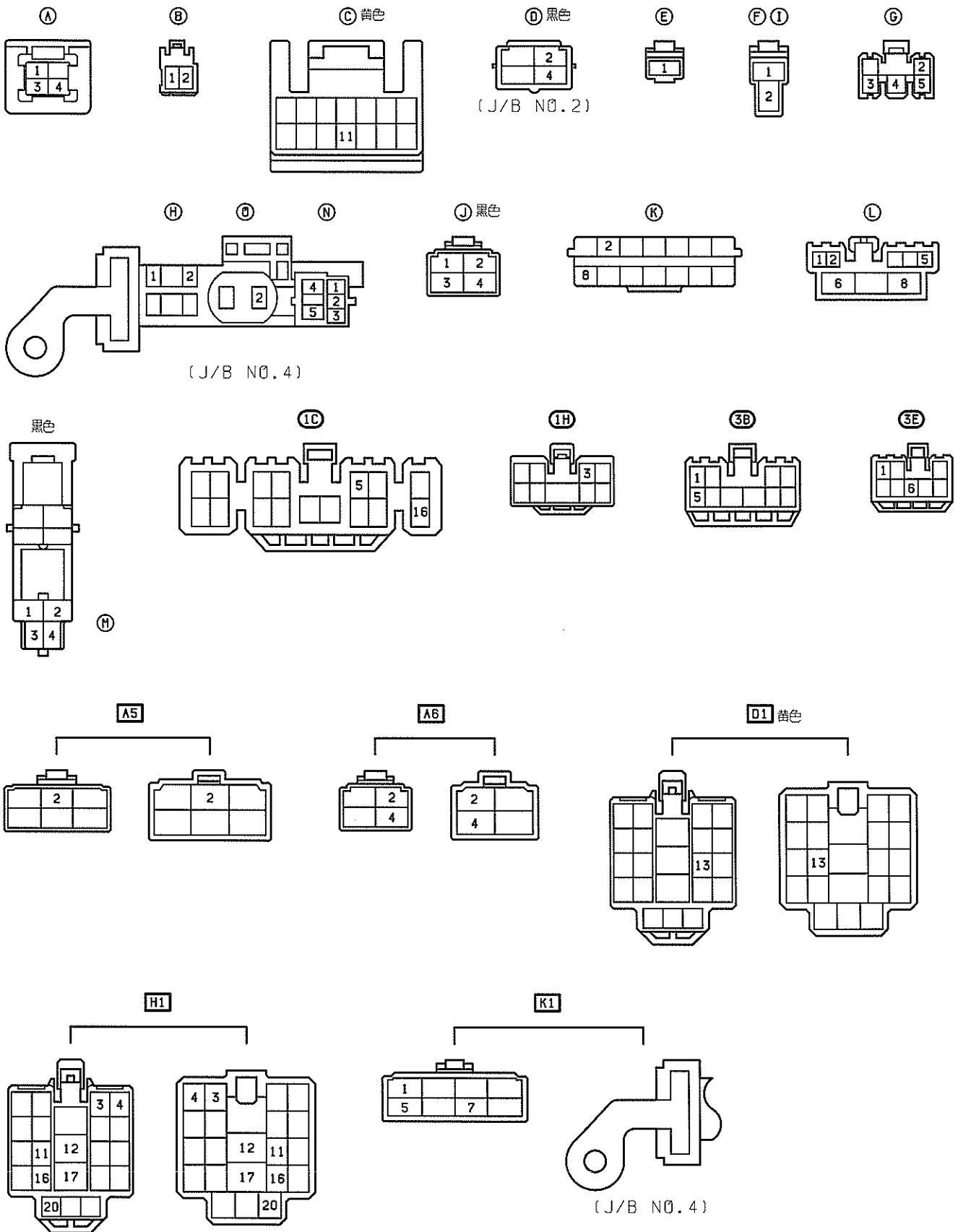

# アースポイント

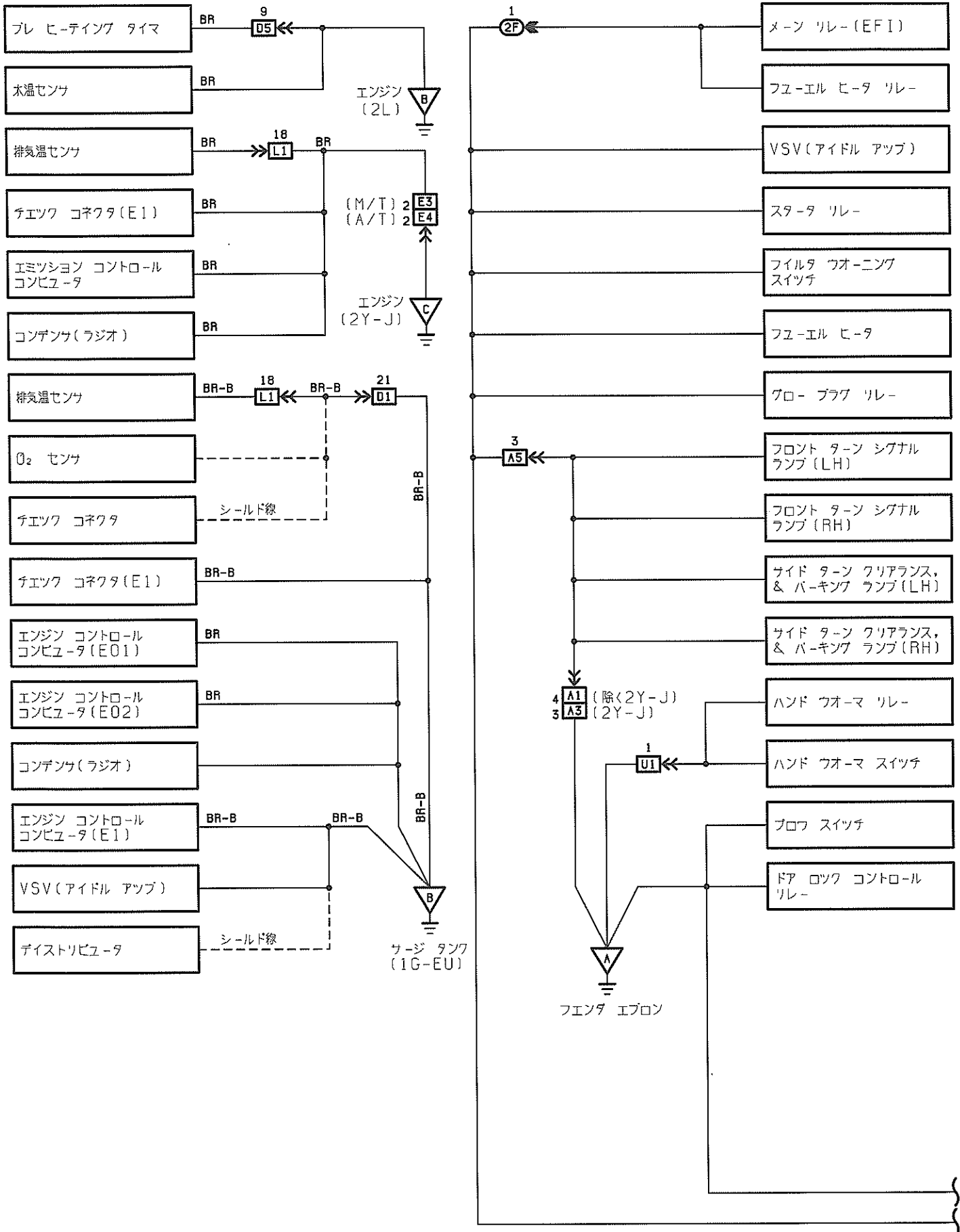

# アース ポイント

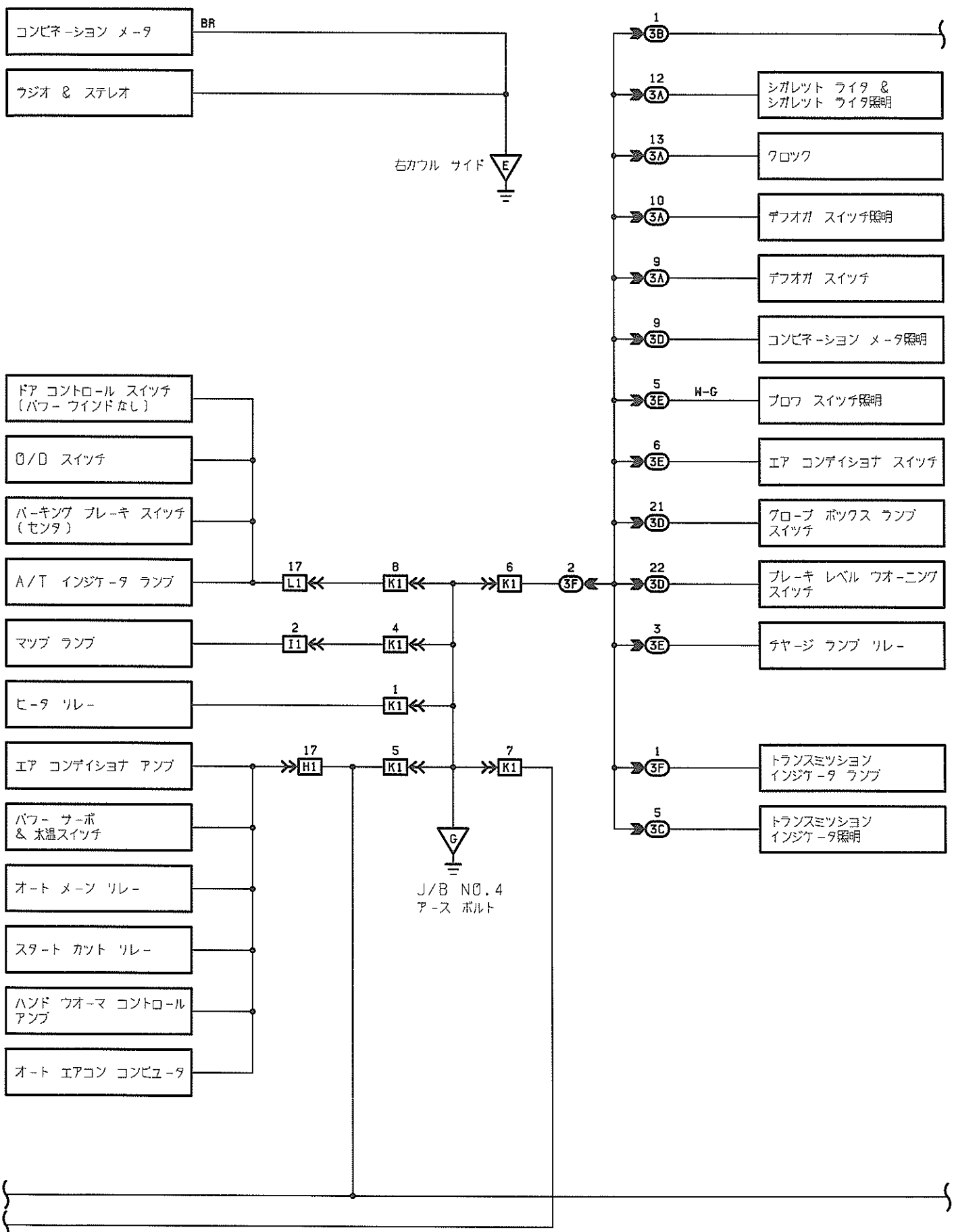

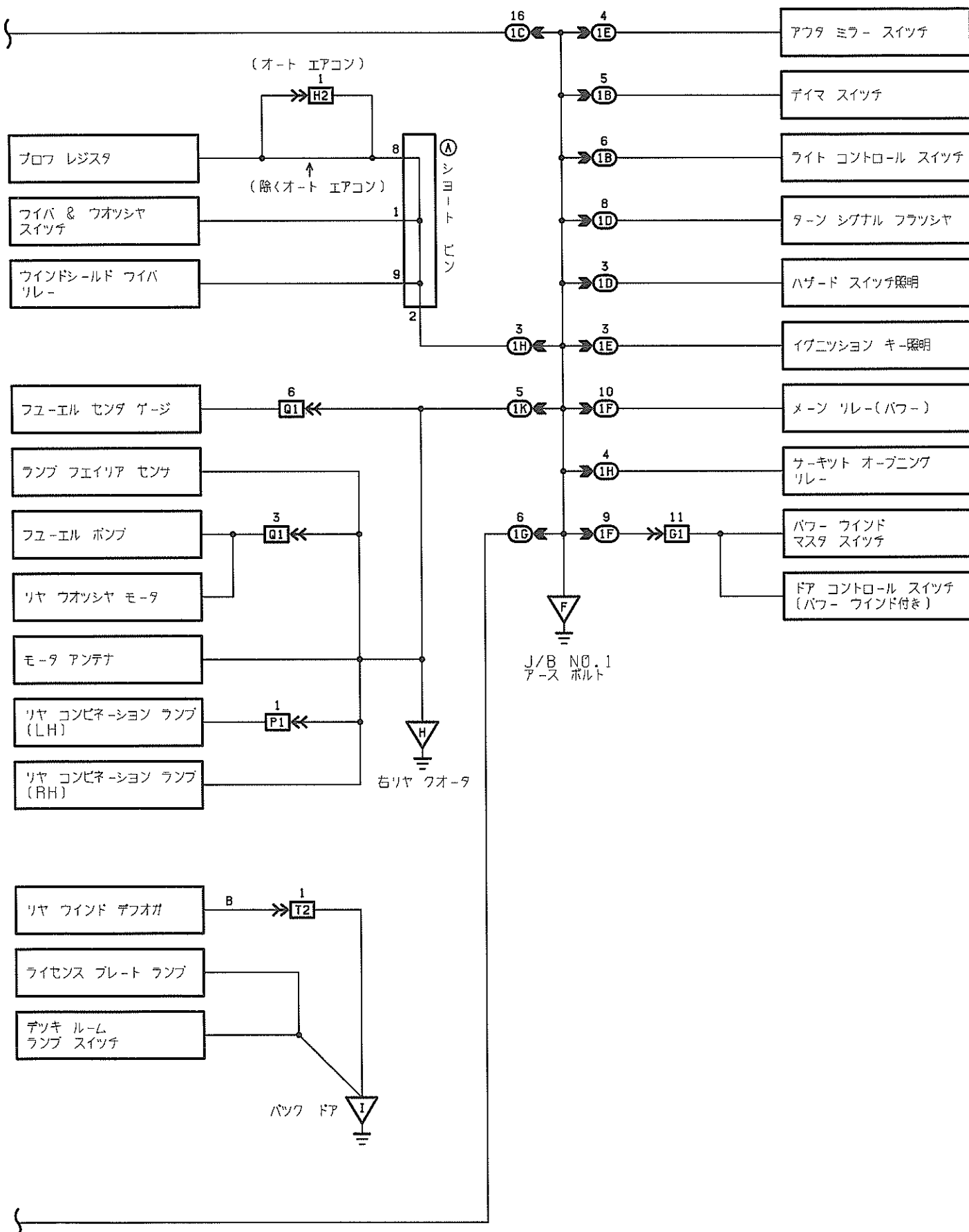

# ≡ アースポイント

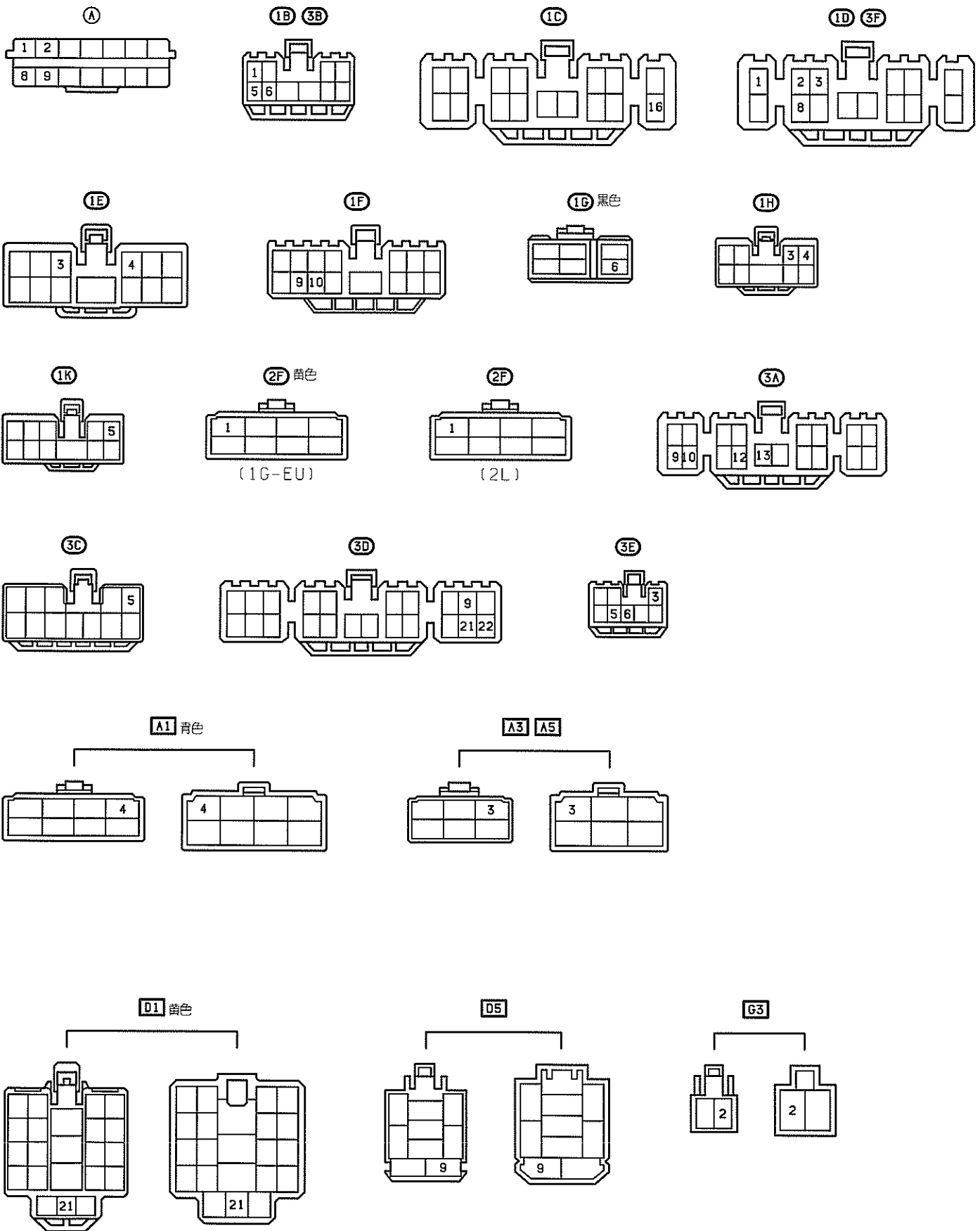

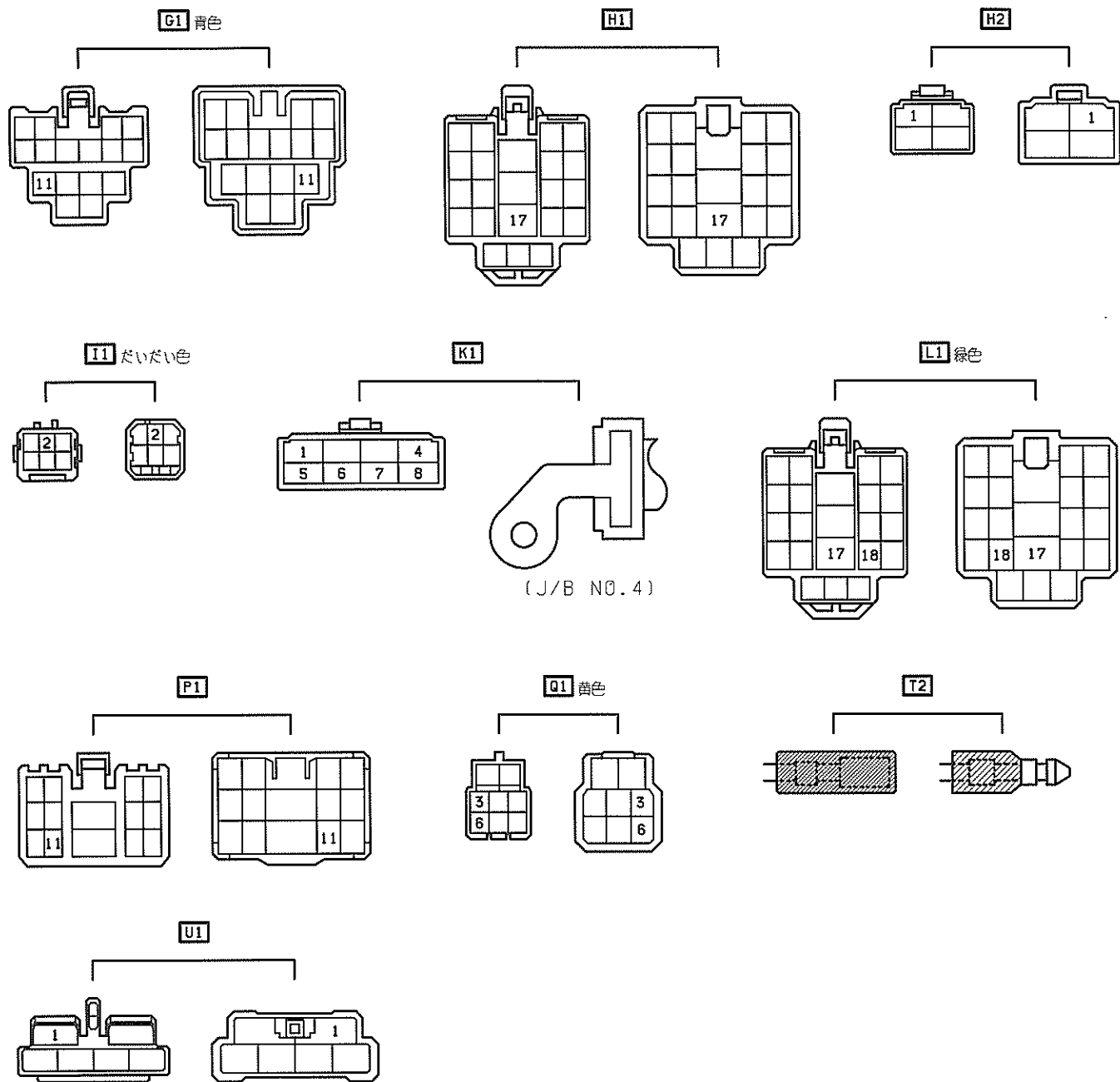

---

MEMO